



This work is protected by copyright and other intellectual property rights and duplication or sale of all or part is not permitted, except that material may be duplicated by you for research, private study, criticism/review or educational purposes. Electronic or print copies are for your own personal, non-commercial use and shall not be passed to any other individual. No quotation may be published without proper acknowledgement. For any other use, or to quote extensively from the work, permission must be obtained from the copyright holder/s.

Towards the rapid and efficient stereoselective synthesis of tetrahydropyrans



A thesis submitted to Keele University in
partial fulfillment for the requirements for the
degree of Doctor of Philosophy in Chemistry

By

Dennis Cooper

December 2016

Abstract

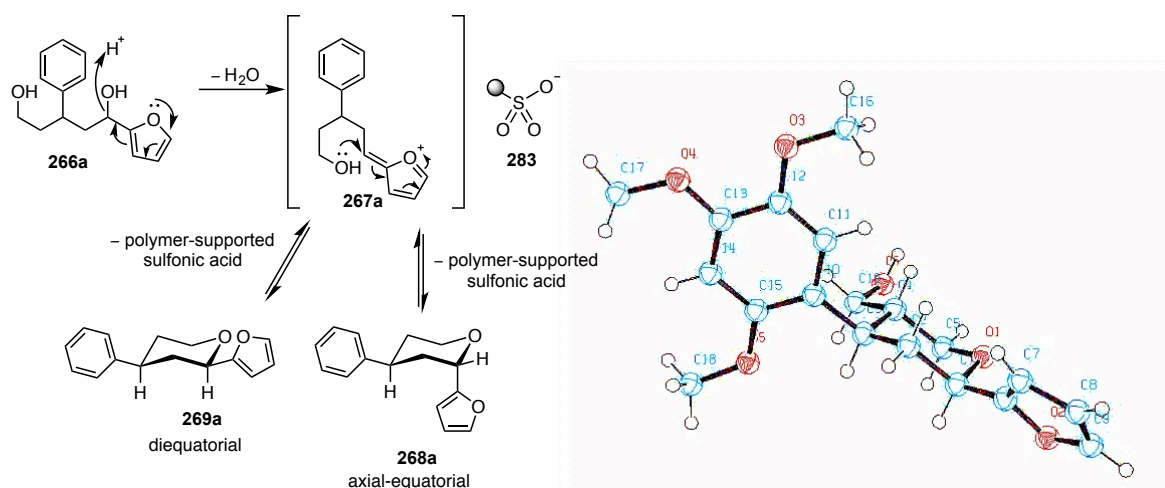

A number of stereoselective syntheses have been investigated employing the ability of a furanyl ether chiral centre to epimerise under acidic conditions, therefore allowing the more stable diastereoisomer to preferentially form under thermodynamic control. As the furanyl group is able to undergo a number of synthetically useful transformations (e.g. Diels-Alder reactions, hydrogenations, oxidative cleavage, Achmatowicz oxidation, etc.) these syntheses represent a highly useful pathway to important moieties in a number of biologically active and pharmaceutically interesting molecules.

Previous work within the group has investigated utilising the acid-catalysed epimerisation of furanyl ether chiral centres on conformationally well-defined scaffolds. This has been demonstrated in the synthesis of 2,6-disubstituted tetrahydropyrans, 2,6-disubstituted piperidines and also in spiroketals. In all cases high levels of stereocontrol were observed.

Attention was focused on the stereoselective synthesis of 2,4-disubstituted and 2,4,5-trisubstituted tetrahydropyrans starting from 'stereorandom' precursors. In all cases high levels of stereocontrol were observed, going from an approximately 1:1 diastereomeric mixture of the corresponding diol or triol to ratios exceeding 10:1 in the case of the disubstituted tetrahydropyrans and to ratios exceeding 15:1:0.9:0 in the case of the trisubstituted tetrahydropyrans. This is due to the rapid epimerisation of the furanyl chiral centre allowing the substituents to adopt the thermodynamically favoured equatorial position on a chair conformation.

Acknowledgements

I would like to extend my upmost thanks to Dr Matthew O'Brien for allowing me the opportunity to conduct this research project and for his continued support and guidance throughout my PhD.

I would like to thank EPSAM (now the Faculty of Natural Sciences) and the School of Physical and Geographical Science for funding this research project alongside the university (Acorn). In addition I would like to thank all members of the synthetic and medicinal chemistry group for all their advice and for continuously encouraging the search of new knowledge in the format of problem classes. In particular I would like to thank Phil Thomson for putting up with me in the office when things were not going to plan and for being able to cheer me up regardless of what mood I was in before!

I wish to extend my thanks to the team of Defy Gravity dance studios, who have not only helped to increase my confidence over the past three years but have also provided an amazing social atmosphere where I have met some very close friends and developed a love of tap dancing and exercise classes!

Finally I would like to extend my deepest heartfelt thanks to my parents who have stood by me and encouraged me every step of the way. Without their love and guidance I wouldn't be here today. For this, and so much more, I am extremely grateful.

Preface

All the work reported herein was conducted in the Shelton Laboratory in the School of Physical and Geographical Sciences (Lennard-Jones Laboratories) at Keele University.

The results have been published and presented in the following papers and conferences:

M. O'Brien and D. Cooper, Continuous flow liquid-liquid separation using a computer-vision control system: the bromination of enamines with *N*-bromosuccinimide, *Synlett*. **2016**, 27, 164

D. Cooper, D. Miles-Barrett and M. O'Brien, Towards a Rapid and Efficient Stereoselective Synthesis of 2,4-Disubstituted Tetrahydropyrans, RSC 23rd International Symposium in Organic Chemistry, 22nd-25th July 2013, St. Catherine's College, Oxford University, Poster

D. Cooper, E. Robbins and M. O'Brien, Towards the Rapid and Efficient Stereoselective Synthesis of 2,4-Disubstituted Tetrahydropyrans, ISACS14 Challenges in Organic Chemistry, 7th-10th August 2014, Shanghai Institute of Organic Chemistry, Shanghai, China, Poster

D. Cooper, High levels of single and double diastereoselectivity *via* epimerisation of a furanyl ether on the tetrahydropyran scaffold, 26th SCI Northern Postgraduate Symposium, 29th April 2015, University of Sheffield, Talk

D. Cooper, E. Robbins and M. O'Brien, Furanyl Cyclic Ethers: Doubly Diastereoselective Synthesis of Di- and Tri-Substituted Tetrahydropyrans, RSC 24th International Symposium: Synthesis in Organic Chemistry, 20th-23rd July 2015, Churchill College, Cambridge University, Poster

D. Cooper, E. Robbins and M. O'Brien, Furanyl Cyclic Ethers: Doubly Diastereoselective Synthesis of Di- and Tri-Substituted Tetrahydropyrans, 30th Heterocycle & Synthesis Group Postgraduate Symposium, 10th September 2015, Lilly UK, Windlesham, Poster and Flash Presentation

Abbreviations

Å	Angstrom
Ac	Acetate
Bn	Benzyl
BOM	Benzyloxymethyl acetal
CSA	Camphorsulfonic acid
CSP	Chiral stationary phase
D	Dextrorotation
DA	Diels-Alder
DBU	1,8-diazabicycloundec-7-ene
DCC	<i>N,N'</i> -dicyclohexylcarbodiimide
DCM	Dichloromethane
DDQ	2,3-dichloro-5,6-dicyanobenzoquinone
DIBAL-H	Diisobutylaluminium hydride
DIEA	<i>N,N</i> -diisopropylethylamine
DMAD	Dimethylacetylenedicarboxylate
DMAP	4-dimethylaminopyridine
DMF	Dimethylformamide
DMSO	Dimethylsulfoxide
DNA	Deoxyribonucleic acid
<i>E</i>	Entgegen
EDTA·2Na	Ethylenediamine tetraacetic disodium salt
eqv.	Equivalents

HDA	Hetero-Diels-Alder
HPLC	High performance liquid chromatography
HSAB	Hard-soft acid-base principle
KHMDS	Potassium bis(trimethylsilyl)amide
L	Levorotation
LDA	Lithium diisopropylamide
LPT	Lithium pyrrolididotrihydroborate
LUMO	Lowest unoccupied molecular orbital
MOM	Methoxy-methyl
MPM	4-methoxyphenyl methyl ether
NaHMDS	Sodium bis(trimethylsilyl)amide
NBS	<i>N</i> -bromosuccinimide
NHK	Nozaki-Hiyama-Kishi
NIS	<i>N</i> -iodosuccinimide
NMR	Nuclear magnetic resonance
nOe	Nuclear Overhauser effect
OTf	Triflate
Ph	Phenyl
PMB	4-methoxybenzyl
PPTS	Pyridinium <i>p</i> -toluenesulfonate
PTFE	Polytetrafluoroethylene
<i>R</i>	Rectus
RCM	Ring closing metathesis
red-Al	Sodium bis(2-methoxyethoxy)aluminium hydride
R _f	Retention factor

S	Sinister
TBAF	Tetrabutylammonium fluoride
TBDMS	<i>Tert</i> -butyldimethylsilyl
TBDPS	<i>Tert</i> -butyldiphenylsilyl
TBS	<i>Tert</i> -butyldimethylsilyl
TFA	Trifluoroacetic acid
THF	Tetrahydrofuran
TIPS	Triisopropylsilyl
TLC	Thin layer chromatography
Z	Zusammen

Table of Contents

Abstract	ii
Acknowledgements	iv
Preface	v
Abbreviations	vii
1. Introduction	1
1.1. Biologically Active Compounds	1
1.1.1. Selected Natural Products	5
1.1.1.1. Eribulin.....	5
1.1.1.2. (-)-Centrolobine	10
1.1.1.3. Bryostatin 1.....	13
1.2. Tetrahydropyrans	15
1.2.1. Strategies used in the Stereoselective Synthesis of Tetrahydropyrans.....	18
1.2.1.1. Tetrahydropyran Synthesis – Prins Cyclisation	18
1.2.1.2. Tetrahydropyran Synthesis – Hetero-Michael Reaction.....	24
1.2.1.3. Tetrahydropyran Synthesis – Hetero-Diels-Alder reaction	29
1.2.1.4. Tetrahydropyran Synthesis – Transition Metal Catalysed Reactions.....	34
1.2.1.5. Tetrahydropyran Synthesis – Ring Closing Metathesis.....	38
1.2.1.6. Tetrahydropyran Synthesis – Other	42
1.3. Previous Work and Aims	45
1.3.1. Previous Work by the Group	45
1.3.2. Aims	53
2. Results and Discussion	54
2.1. Working Towards the Synthesis of Azaspiroketal	54
2.2. Development of a 4-furanyl-4-hydroxy-Organometallic Coupling Partner	63
2.3. Stereoselective Synthesis of 4-aryl-2-furyl Tetrahydropyrans	85
2.4. Stereoselective Synthesis of 4-aryl-2-furyl-5-hydroxymethyl Tetrahydropyrans	117
2.5. Synthesis of 4-aryl-2,6-difuranyl Tetrahydropyrans	134
2.6. Continuous-Flow Chemistry System	148
2.6.1. An Introduction to Continuous-Flow Chemistry.....	148
2.6.2. Developing a Continuous-Flow System for Liquid-Liquid Extraction	155
2.6.3. Testing Reactions for their Suitability for the Continuous-Flow System	158
2.6.4. Halogenation of Enaminones in Continuous-Flow.....	168
2.7. Future Work	182
3. Conclusions	185
4. References	189
5. Experimental	203
5.1. General Experimental Information	203
5.2. Data for Compounds Synthesised from the Azaspiroketal Synthesis	207
5.3. Data from Organometallic Coupling Partner Synthesis	214
5.4. Data for Compounds Synthesised in the Formation of 2,4-Disubstituted Tetrahydropyrans	224
5.5. Data for Compounds Synthesised in the Formation of 2,4,5-Trisubstituted Tetrahydropyrans	277
5.6. Data from the Synthesis of 4-Aryl-2,6-Difuranyl Tetrahydropyrans	300
5.7. Data for the Continuous-Flow Test Reactions and Bromination of Enaminones	311

5.8. Experimental References.....	332
Appendix A – X-ray Crystal Data.....	334

Table of Figures

FIGURE 1.1: STRUCTURES OF BRYOSTATIN 1 AND PACLITAXEL.....	2
FIGURE 1.2: STRUCTURE OF STRYCHNINE.....	3
FIGURE 1.3: ENANTIOMERS OF THALIDOMIDE	4
FIGURE 1.4: STRUCTURE OF HALICHONDRIIN B	5
FIGURE 1.5: ERIBULIN – A COMPOUND THAT POSSESSES NINETEEN STEREOGENIC CENTRES.....	6
FIGURE 1.6: STRUCTURE OF (-)-CENTROLOBINE	10
FIGURE 1.7: EXAMPLES OF BIOLOGICALLY ACTIVE TETRAHYDROPYRAN-CONTAINING NATURAL PRODUCTS.....	16
FIGURE 1.8: PHARMACEUTICALS DEVELOPED SINCE 1993 THAT CONTAIN THE PIPERIDINE MOIETY	17
FIGURE 1.9: TRANSITION STATES SHOWING HOW DOUBLE BOND GEOMETRY AFFECTS THE STEREOCHEMICAL OUTCOME OF THE OXY-MICHAEL REACTION	27
FIGURE 1.10: EXO AND ENDO TRANSITION STATES OF LUGER'S HETERO-DIELS-ALDER REACTION	31
FIGURE 1.11: COPPER-BOX COMPLEX CATALYST.....	33
FIGURE 2.1: THEORISED POTENTIAL OUTCOMES OF THE 6,6-AZA-SPIROKETAL FORMATION.....	55
FIGURE 2.2: THEORISED ACETAL IMPURITY FORMED DURING THE FORMATION OF THE BENZOTRIAZOLE ADDUCT	67
FIGURE 2.3: ¹ H-NMR SPECTRUM OF THE CYCLISATION OF DIOL 266A TO TETRAHYDROPYRAN 269A	106
FIGURE 2.4: EXPANDED SPECTRUM FROM THE CYCLISATION OF DIOL 266A TO TETRAHYDROPYRAN 269A	107
FIGURE 2.5: 2D-NOESY SPECTRUM OF TETRAHYDROPYRAN 269A	111
FIGURE 2.6: 2D NOESY SPECTRUM OF TETRAHYDROPYRAN 268A	112
FIGURE 2.7: X-RAY CRYSTAL STRUCTURE 269E	113
FIGURE 2.8: X-RAY CRYSTAL STRUCTURE 269G	114
FIGURE 2.9: X-RAY CRYSTAL STRUCTURE OF THE <i>PARA</i> -CHLORO TRIOL.....	121
FIGURE 2.10: ¹ H-NMR COMPARISON FOR THE CYCLISATION OF TRIOL 287A OVER TWO DAYS	124
FIGURE 2.11: THE FOUR DIASTEREOMERS OF 2,4,5-TRISUBSTITUTED TETRAHYDROPYRAN 288A	125
FIGURE 2.12: 2D-NOESY SPECTRUM OF THE DIASTEREOMERIC MIXTURE PRODUCED FROM THE CYCLISATION OF TRIOL 287D	126
FIGURE 2.13: NMR OVERLAYS FOR THE <i>PARA</i> -CHLORO TRISUBSTITUTED TETRAHYDROPYRAN DIASTEREOMERIC MIXTURES BETWEEN 5.25 AND 2.25 PPM.....	131
FIGURE 2.14: X-RAY CRYSTAL STRUCTURE OF THE TRIMETHOXY TRISUBSTITUTED TETRAHYDROPYRAN	133
FIGURE 2.15: DIFURANYL DIOL DIASTEREOMERS.....	137
FIGURE 2.16: NMR ANALYSIS OF THE CYCLISATION REACTION TO YIELD THE DIFURANYL TETRAHYDROPYRANS OVER THE COURSE OF FOUR DAYS	139
FIGURE 2.17: PUTATIVE STRUCTURE OF THE BY-PRODUCT FORMED DURING THE COURSE OF THE CYCLISATION REACTION	141
FIGURE 2.18: POSSIBLE DIASTEREOMERS OF TETRAHYDROPYRAN COMPOUND 292c	145
FIGURE 2.19: PSEUDO-STEREOGENIC CENTRE THAT COULD BE SEEN IN 292c-II AND 292c-IV	146
FIGURE 2.20: GENERAL SCHEMATIC FOR THE GRAVITY-BASED LIQUID-LIQUID SEPARATOR IN CONTINUOUS- FLOW.....	157
FIGURE 2.21: ENAMINONES SYNTHESISED.....	170
FIGURE 2.22: NMR SPECTRA OF THE REACTION PRODUCT WITH EXTRACTION, WITH AQUEOUS SOLUTION AND WITHOUT.....	178
FIGURE 2.23: CAMERA IMAGES AND PROCESSED IMAGES FOCUSING ON THE SEPARATING VESSEL AT VARIOUS TIMES	180
FIGURE 2.24: POTENTIAL NATURAL PRODUCTS FOR FUTURE SYNTHETIC INVESTIGATIONS	183

Table of Schemes

SCHEME 1.1: CATALYTIC PATHWAY FOR THE NOZAKI-HIYAMA-KISHI COUPLING	8
SCHEME 1.2: TETRAHYDROPYRAN FORMATION IN THE SYNTHESIS OF ERIBULIN	9
SCHEME 1.3: SYNTHESIS OF HYDROXYKETONE FOR USE IN THE SYNTHESIS OF (-)-CENTROLOBINE.....	12
SCHEME 1.4: CONSTRUCTION OF TETRAHYDROPYRAN RING IN THE ASYMMETRIC SYNTHESIS OF (-)- CENTROLOBINE	13
SCHEME 1.5: INITIAL STUDIES LEADING TO THE DEVELOPMENT OF THE PRINS CYCLISATION	18
SCHEME 1.6: GENERALISED PRINS CYCLISATION	19
SCHEME 1.7: PRINS CYCLISATION WHERE AN ELECTRON-RICH AROMATIC RING IS ADJACENT TO THE ALCOHOL. THE COMPETING OXONIA-COPE REARRANGEMENT IS ALSO SHOWN	21
SCHEME 1.8: RYCHNOVSKY'S TETRAHYDROPYRAN FORMATION FROM THE CORRESPONDING α -ACETOXY ETHER	22
SCHEME 1.9: LOH'S INDIUM CATALYSED 2,4,5,6-TETRASUBSTITUTED TETRAHYDROPYRAN FORMATION ...	22
SCHEME 1.10: MECHANISM EXPLORING THE STEREOCHEMICAL OUTCOME OF LOH'S FORMATION OF 2,4,5,6-TETRASUBSTITUTED TETRAHYDROPYRANS	23
SCHEME 1.11: MAIER'S SYNTHESIS OF NEOPELTOLIDE UTILISING THE PRINS CYCLISATION	24
SCHEME 1.12: GENERALISED OXY-MICHAEL ADDITION	26
SCHEME 1.13: COMBINING THE OXY-MICHAEL REACTION AND THE TSUJI-TROST COUPLING	28
SCHEME 1.14: USE OF THE OXY-MICHAEL REACTION IN THE SYNTHESIS OF A TETRAHYDROPYRAN RING IN THE EF SEGMENT OF SPONGISTATIN 1	29
SCHEME 1.15: METAL CHELATION AFFECTING THE STEREOCHEMICAL OUTCOME OF THE HETERO-DIELS- ALDER REACTION	31
SCHEME 1.16: AN ACTIVATED DIENE BEING USED IN THE HETERO-DIELS-ALDER REACTION – BOTH PATHWAYS SHOWN	32
SCHEME 1.17: JACOBSEN'S DEVELOPMENT OF THE HETERO-DIELS-ALDER REACTION USING A TRIDENTATE SCHIFF BASE CHROMIUM (III) COMPLEX	33
SCHEME 1.18: HDA REACTION EMPLOYED IN THE SYNTHESIS OF (+)-AZASPIRACID	34
SCHEME 1.19: GENERALISED Pd(0) CATALYSED RING CLOSURE.....	35
SCHEME 1.20: TROST'S WORK ON PALLADIUM-CATALYSED CHEMOSELECTIVE CYCLIC ETHER FORMATION	35
SCHEME 1.21: GOLD-CATALYSED REACTION OF HOMOPROPARGYLIC ETHERS.....	36
SCHEME 1.22: (-)-LAULIMALIDE SYNTHESIS USING PALLADIUM (II)	37
SCHEME 1.23: TWO CLASSES OF RING CLOSING METATHESIS REACTIONS.....	39
SCHEME 1.24: ENANTIOSELECTIVE SYNTHESIS OF SCH 351448 USING A DOUBLE RING CLOSING METATHESIS/CROSS METATHESIS TANDEM REACTION	41
SCHEME 1.25: NUCLEOPHILIC EPOXIDE OPENING TO FORM THE SATURATED OXYGEN HETEROCYCLE	43
SCHEME 1.26: STABILISATION OF THE ENDO PATHWAY WITH AN ADJACENT PI-SYSTEM	43
SCHEME 1.27: EPOXIDE OPENING UTILISED IN THE SYNTHESIS OF A BRYOSTATIN 1 PRECURSOR	44
SCHEME 1.28: EXAMPLES OF FURANYL GROUPS UNDERGOING A) A DIELS-ALDER REACTION B) A PIANCATELLI REACTION C) AN ACHMATOWICZ OXIDATION	46
SCHEME 1.29: CYCLISATION METHOD EMPLOYED BY THE GROUP.....	47
SCHEME 1.30: PREVIOUSLY COMPLETED SYNTHESIS OF 2,6-DISUBSTITUTED TETRAHYDROPYRANS BY THE GROUP	48
SCHEME 1.31: SYNTHESIS OF THE CIVET CAT COMPOUND	49
SCHEME 1.32: PREVIOUSLY COMPLETED SYNTHESIS OF 2,6-DISUBSTITUTED PIPERIDINES BY THE GROUP	50
SCHEME 1.33: MECHANISM FOR THE CYCLISATION AND EPIMERISATION OF 2,6-DISUBSTITUTED PIPERIDINES	51
SCHEME 1.34: ELIMINATION-ADDITION MECHANISM IN THE SYNTHESIS OF SPIROKETAL BY THE GROUP	51
SCHEME 1.35: PREVIOUS SYNTHESIS OF SPIROKETALS COMPLETED BY THE GROUP.....	52
SCHEME 2.1: RETROSYNTHETIC ANALYSIS TO THE 6,6-AZASPIROKETAL	57
SCHEME 2.2: TOSYLATION AND OXIDATION OF STARTING PIPERIDINES.....	58
SCHEME 2.3: ATTEMPTED COUPLING OF ALKYNE AND TOSYLATED PIPERIDINONE AND SUBSEQUENT DEPROTECTION	59
SCHEME 2.4: HYDROGENATION AND CYCLISATION STEPS REQUIRED TO COMPLETE THE 6,6- AZASPIROKETAL SYNTHESIS	61
SCHEME 2.5: REDUCTION REACTION THAT CAN BE SEEN COMPETING WITH THE NUCLEOPHILIC ADDITION OF A GRIGNARD REAGENT WHEN A β -HYDROGEN IS PRESENT	64
SCHEME 2.6: POTENTIAL USES FOR THE ORGANOMETALLIC COUPLING PARTNER	65
SCHEME 2.7: REACTION OF 5-METHYLFURFURAL TO YIELD THE BENZOTRIAZOLE ADDUCT	66

SCHEME 2.8: FORMATION OF BROMOKETONE	67
SCHEME 2.9: FORMATION OF <i>TERT</i> -BUTYLDIMETHYLSILYL IMIDAZOLE AND THE SUBSEQUENT PROTECTION OF AN ALCOHOL.....	70
SCHEME 2.10: POTENTIAL MECHANISM FOR THE THEORISED IMPURITY SEEN DURING THE REDUCTION AND PROTECTION OF THE BROMOKETONE	71
SCHEME 2.11: SUMMARY OF THE REACTIONS TESTED TO OBTAIN THE TBS-PROTECTED ALCOHOL.....	72
SCHEME 2.12: ATTEMPTED CONVERSION OF A HYDROXYL GROUP TO A METHOXY GROUP UNDER ACIDIC CONDITIONS.....	73
SCHEME 2.13: FORMATION OF GRIGNARD REAGENT WITH AN IODINE CATALYST.....	74
SCHEME 2.14: ATTEMPTED GRIGNARD COUPLING	74
SCHEME 2.15: RETROSYNTHESIS OF 4-FURANYL-4-METHOXYBUTYL IODIDE	75
SCHEME 2.16: PROCEDURE FOLLOWED TO ACHIEVE 250	76
SCHEME 2.17: CONVERSION OF THE HYDROXYL GROUP TO THE METHYL ETHER	78
SCHEME 2.18: REMOVAL OF THE BENZOATE ESTER THROUGH BASE HYDROLYSIS	79
SCHEME 2.19: CONVERSION OF THE PRIMARY ALCOHOL TO THE CORRESPONDING IODIDE.....	79
SCHEME 2.20: MECHANISM OF THE APPEL-TYPE REACTION SHOWING HOW IMIDAZOLE CAN FORM A REACTIVE INTERMEDIATE PHOSPHINE SPECIES	81
SCHEME 2.21: THE DENTON GROUP'S USE OF POLYSTYRENE-BOUND PHOSPHINE OXIDE IN THE APPEL-TYPE REACTION.....	82
SCHEME 2.22: CONCEPTUAL IDEA FOR THE SYNTHESIS OF 2,4-DISUBSTITUTED TETRAHYDROPYRANS.....	85
SCHEME 2.23: RETROSYNTHETIC ANALYSIS OF 2,4-DISUBSTITUTED TETRAHYDROPYRANS	86
SCHEME 2.24: CHALCONE FORMATION VIA A CLAISEN-SCHMIDT CONDENSATION	88
SCHEME 2.25: MICHAEL ADDITION OF DIMETHYL MALONATE USING SODIUM HYDRIDE	90
SCHEME 2.26: MECHANISM OF THE CONJUGATE ADDITION OF DIMETHYL MALONATE TO THE STARTING CHALCONES	92
SCHEME 2.27: CONJUGATE ADDITION USING POTASSIUM CARBONATE	93
SCHEME 2.28: KRAPCHO DECARBOXYLATION OF KETO-DIESTERS	95
SCHEME 2.29: MECHANISM OF THE KRAPCHO DECARBOXYLATION REACTION USING A CHLORIDE ANION AND 271A AS SUBSTRATE EXAMPLES.....	96
SCHEME 2.30: ROUTE INVESTIGATED AS AN ALTERNATIVE TO THE KRAPCHO DECARBOXYLATION STEP ...	99
SCHEME 2.31: LITHIUM ALUMINIUM HYDRIDE REDUCTION OF KETO-ESTERS TO FORM THE 1,5-DIOL MOIETIES	100
SCHEME 2.32: CYCLISATION OF 1,5-DIOLS UNDER ACIDIC CONDITIONS TO FORGE THE 2,4-DISUBSTITUTED TETRAHYDROPYRAN STRUCTURE.....	103
SCHEME 2.33: MECHANISM FOR THE CYCLISATION OF THE 1,5-DIOL 266A TO THE CORRESPONDING TETRAHYDROPYRAN	108
SCHEME 2.34: CYCLISATION OF A 1,5-DIOL UNDER BASIC CONDITIONS.....	109
SCHEME 2.35: CONVERSION OF THE FURANYL GROUP TO THE CORRESPONDING TERMINAL ALCOHOL ...	115
SCHEME 2.36: THEORISED FORMATION OF 2,4,5-TRISUBSTITUTED TETRAHYDROPYRANS	118
SCHEME 2.37: LITHIUM ALUMINIUM HYDRIDE REDUCTION OF KETO-DIESTERS TO THE CORRESPONDING TRIOL	119
SCHEME 2.38: CYCLISATION OF TRIOLS TO YIELD THE 2,4,5-TRISUBSTITUTED TETRAHYDROPYRANS.....	122
SCHEME 2.39: ATTEMPTED BASE CYCLISATION OF 287B	127
SCHEME 2.40: A SUMMARY OF HOW ALL <i>PARA</i> -CHLORO TRISUBSTITUTED TETRAHYDROPYRAN DIASTEREOISOMERS WERE OBTAINED	129
SCHEME 2.41: RETROSYNTHETIC ANALYSIS OF 4-ARYL-2,6-DIFURANYL TETRAHYDROPYRANS.....	134
SCHEME 2.42: REACTION BETWEEN CHALCONES AND 2-ACETYLFURAN TO SYNTHESISE THE DIFURANYL DIKETONES	135
SCHEME 2.43: REDUCTION OF THE DIFURANYL DIKETONE TO THE CORRESPONDING DIOL	136
SCHEME 2.44: CYCLISATION OF DIFURANYL DIOLS TO THE CORRESPONDING 2,4,6-TRISUBSTITUTED TETRAHYDROPYRAN	138
SCHEME 2.45: PLAUSIBLE MECHANISM FOR THE FORMATION OF THE ALDEHYDE BY-PRODUCT	142
SCHEME 2.46: LI'S GOLD-CATALYSED FURANYL MIGRATION MECHANISM.....	143
SCHEME 2.47: TOSYLATION-CYCLISATION OF A DIFURANYL DIOL	144
SCHEME 2.48: MOFFATT-SWERN OXIDATION	152
SCHEME 2.49: WACKER OXIDATION COMPLETED IN A CONTINUOUS-FLOW SYSTEM.....	154
SCHEME 2.50: FLOW CHEMISTRY TEST REACTION BETWEEN BENZALDEHYDE AND METHYL CARBAZATE .	158
SCHEME 2.51: FLOW CHEMISTRY TEST REACTION BETWEEN 2-CHLOROPHENYLISOCYANATE AND BENZYLAMINE.....	161

SCHEME 2.52: LEY AND CO-WORKERS CONTINUOUS-FLOW REACTION BETWEEN ALDEHYDES AND 1,3-PROPANEDITHIOL	165
SCHEME 2.53: FLOW CHEMISTRY TEST REACTION BETWEEN BENZALDEHYDE AND 1,2-ETHANEDITHIOL..	165
SCHEME 2.54: FLOW CHEMISTRY TEST REACTION BETWEEN ACETOPHENONE AND 1,2-ETHANEDITHIOL.	166
SCHEME 2.55: FLOW CHEMISTRY TEST REACTION BETWEEN CARBONYL GROUPS AND ETHYLENE GLYCOL	167
SCHEME 2.56: GENERAL REACTION FOR THE FORMATION OF ENAMINONES.....	170
SCHEME 2.57: BROMINATION OF ENAMINONES USING NBS	171

Table of Tables

TABLE 2.1: SUMMARY OF CONDITIONS USED WITH THE TOSYLATED PIPERIDINONE 191 AND FURANYL ALKYNE 192	60
TABLE 2.2: REACTION CONDITIONS USED TO OBTAIN THE BENZOTRIAZOLE ADDUCT.....	66
TABLE 2.3: REDUCTION REACTIONS TESTED WITH BROMOKETONE	71
TABLE 2.4: CHALCONES PRODUCED FOR THE SYNTHESIS OF 2,4-DISUBSTITUTED TETRAHYDROPYRANS ..	88
TABLE 2.5: MICHAEL ADDITION PRODUCTS FROM THE SYNTHESIS OF 2,4-DISUBSTITUTED TETRAHYDROPYRANS	90
TABLE 2.6: KRAPCHO DECARBOXYLATION PRODUCTS FROM THE 2,4-DISUBSTITUTED TETRAHYDROPYRAN SYNTHESIS.....	95
TABLE 2.7: SOLVENT SYSTEMS AND SALTS TESTED FOR THE KRAPCHO DECARBOXYLATION.....	97
TABLE 2.8: DIOLS SYNTHESISED ALONG THE SYNTHETIC ROUTE TO 2,4-DISUBSTITUTED TETRAHYDROPYRANS	100
TABLE 2.9: 2,4-DISUBSTITUTED TETRAHYDROPYRANS SYNTHESISED AND THEIR RESPECTIVE DIASTEREOMERIC RATIOS	103
TABLE 2.10: ACIDS TESTED FOR USE IN THE CYCLISATION OF 1,5-DIOLS TO THE CORRESPONDING TETRAHYDROPYRANS	104
TABLE 2.11: TRIOLS SYNTHESISED DURING THE ROUTE TO ACHIEVE 2,4,5-TRISUBSTITUTED TETRAHYDROPYRANS	119
TABLE 2.12: 2,4,5-TRISUBSTITUTED TETRAHYDROPYRANS SYNTHESISED AND THE DIASTEREOMERIC RATIOS OBTAINED.....	122

Table of Graphs

GRAPH 2.1: CALIBRATION OF THE MILTON ROY CONSTAMETRIC III METERING PUMP.....	175
GRAPH 2.2: CALIBRATION OF THE LKB BROMMA 2150 HPLC PUMP	176
GRAPH 2.3: CALIBRATION OF THE WATERS 510 HPLC PUMP	176

1. Introduction

1.1. Biologically Active Compounds

There are a plethora of compounds that demonstrate biological activity, whether beneficial or adverse, on living matter. A large number of these are natural products or their analogues,¹ and they can vary greatly in their bioactive properties amongst structurally related compounds or even amongst enantiomers.² This is due to the importance of the three dimensional, spatial orientation when the compound interacts with biological systems.³

Throughout human history people have utilised traditional folk remedies and passed the knowledge of this down to their descendants.⁴ A classic example of this is in the case of aspirin. Aspirin is synthesised from salicylic acid, which is an active ingredient of analgesic herbal remedies, including willow bark, which the ancient Egyptians and Romans consumed to relieve aches and pains.⁵ Although in many cases we now know the active ingredient of these remedies, there are far more cases where the compound responsible for the biological effect is not yet known. This is unsurprising based on the high levels of structural diversity seen throughout the natural world in these biologically active compounds.

Structural diversity stems from numerous variations that can be seen amongst functional groups; the spatial arrangement of atoms; variation in scaffolds present in the compound and the variation of structural groups present about a common backbone.³

This chemical diversity has led to natural products being a driving force behind pharmaceutical discovery.⁶ Of the commercial drugs currently available 70% are derivatives of compounds isolated from nature that have exhibited biological activity.⁷

These extremely useful compounds come from a wide variety of sources (such as plants, fungi, marine sponges, etc.) and include the tetrahydropyran containing compound bryostatin 1 (**1**), which inhibits tumour growth and angiogenesis (the formation of new blood vessels from already pre-existing ones).⁷ Bryostatin 1 (**1**) is often used in conjunction with paclitaxel (Taxol[®]) (**2**) as an anticancer treatment;⁸ however, paclitaxel is an effective anticancer agent in its own right and works by promoting tubulin polymerisation and the stabilisation of microtubules.⁹ This interrupts cell division and promotes apoptosis (cell death).

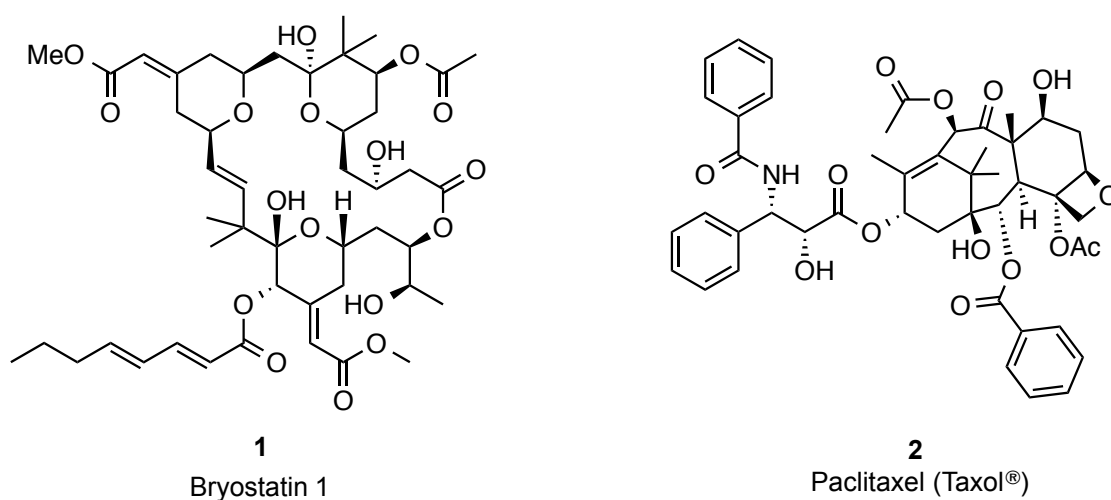

Figure 1.1: Structures of bryostatin 1 and paclitaxel (Taxol[®]).

Although natural products are often bioactive and have an array of potential uses, there are a number of disadvantages associated with them. The major

disadvantage is the extraction and isolation can be difficult and tedious.¹⁰ In some cases the compounds are present in sufficiently high abundances within the biological material, or possess suitable chemical properties (for example the basicity of alkaloids) that isolation can be achieved *via* distillation or recrystallisation. This is the case for strychnine (**3**), a highly poisonous compound that has previously been used in pest management. Strychnine can be easily isolated from *Nux vomica* seeds by grinding, as each one of the seeds can contain up to 3% of the natural product.¹¹

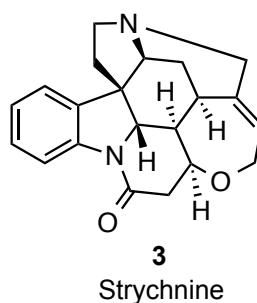

Figure 1.2: Structure of strychnine.

In many other cases the quantity of the desired natural product within the biological material is so small that various chromatographic methods need to be used instead.¹² This is the case with the compound paclitaxel (**2**), which is extracted from the Pacific Yew. The bark of three mature trees yields one gram of paclitaxel; however worldwide demand in 2009 was for 250 kilograms.¹³ This is one of the reasons that stereoselective synthetic pathways to biologically active compounds are of such great importance.¹ Current synthesis of paclitaxel is achieved through the derivatisation of a similar compound that is much more readily available from the English Yew¹⁴ but, despite this, stereoselective

synthesis is still important as it allows for the development of new and effective methodologies; grants material for research purposes that may be difficult to obtain in such quantities *via* extraction and it can also allow access to other, often simpler, derivatives that may possess higher levels of activity, or may be easier to synthesise and therefore be more viable for commercial synthesis. This was seen in the case of eribulin, a simplified derivative of the natural product halichondrin B; that is both totally synthetic and also complex, containing a number of stereocentres (see section 1.1.1.)

Stereoselective synthesis is extremely important and different stereoisomers of a compound may have vastly different effects. This was demonstrated in 1957 when an anti-emetic drug known as thalidomide was sold as a racemate and marketed as being suitable for pregnant women.¹⁵ The (*R*)-(+)-isomer (**4a**) did have this effect; however, the (*S*)-(-)-isomer (**4b**) possessed significant teratogenic activity. In other words, it could significantly disturb the development of an embryo or foetus, resulting in birth defects.¹⁶ It was also discovered that the (*R*)-isomer is racemised within the body.

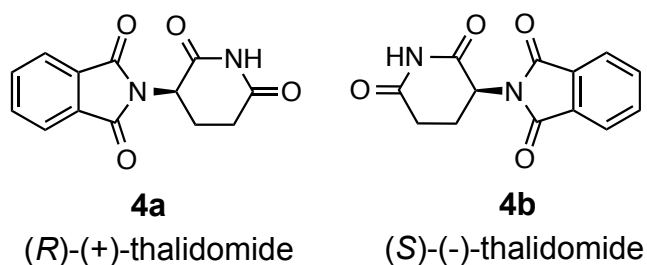

Figure 1.3: Both enantiomers of thalidomide. Image adapted from reference 17.

This worldwide disaster led to pharmaceutical companies being required to investigate the biological activity and effects of single enantiomers and highlights why stereoselective synthesis is so important.

1.1.1. Selected Natural Products

This section will focus on selected tetrahydropyran-containing natural products, their biological activity and the key step in their synthesis. Other synthetic methods will be covered later in this thesis (see section 1.2.).

1.1.1.1. Eribulin

In 1986 eight antitumour compounds were isolated from *Halichondria okadai*,¹⁸ a marine sponge that can be found, widely distributed, about the Pacific coast of Japan.¹⁹ One of these compounds was halichondrin B (**5**). In 1992 the Kishi group published the total synthesis of this molecule,²⁰ which possesses 32 stereocentres, meaning that it can adopt over four billion different stereoisomers.²¹ The longest linear sequence in this synthesis was 47 steps, but in total the synthesis was 90 steps and therefore impractical in terms of drug development²² despite tests revealing that it possesses potent antimitotic and antitumour activities.²³

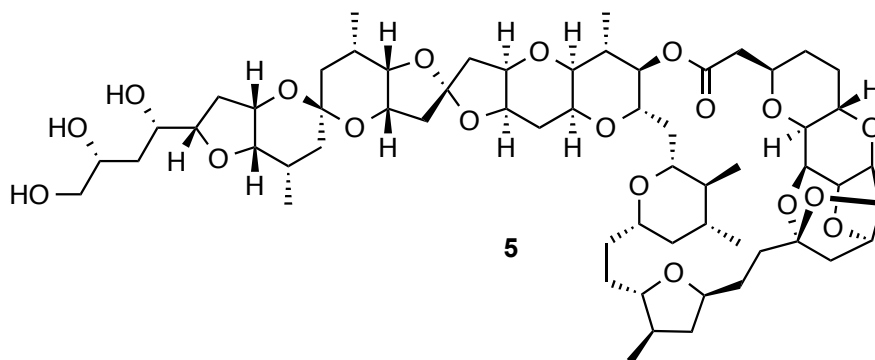

Figure 1.4: Structure of Halichondrin B.

Eisai (a Japanese pharmaceutical company) collaborated with Kishi in order to explore the structure-activity relationships of halichondrin B (**5**) and it was found that the macrocyclic ketone structure is the key to the antitumour properties of the molecule. This work led to the development of the chemically and biologically optimised totally synthetic drug derived from halichondrin B (**5**) known as eribulin (**6**) (commercially called Halaven[®]).²⁴ This compound shows anticancer activity against a number of human cancer lines including breast cancer, lymphoma and prostate cancer.²⁵

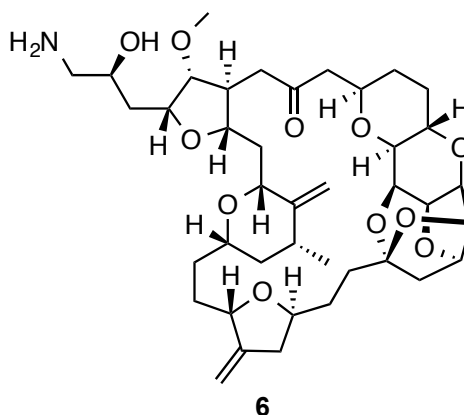

Figure 1.5: Eribulin – a compound that possesses nineteen stereogenic centres.²⁶

Eribulin (**6**) is a derivative of an intermediate from the total synthesis of compound **5** by Kishi and co-workers and was found to be moderately more active than its parent compound.²³ In 2010 Halaven[®] was approved as a drug treatment for metastatic breast cancer.²⁷ Metastasis refers to tumour migration. Hence metastatic breast cancer is an advanced form of breast cancer where the tumours are migrating to other organs. Approximately 10 – 15% of patients will develop this advanced form within three years of the original diagnosis.²⁸ The following year

(2011), Halaven[®] was entered into new trials for the treatment of non-small cell lung cancer and prostate cancer. These trials are still ongoing.²⁹

The commercial synthetic route to eribulin was 62 steps but, in 2015, seven steps were added to this in order to reduce the cost and waste of the synthesis by 80% by removing the need for column chromatography.²¹

The reaction scheme followed for the synthesis of eribulin was the same as the initial synthetic route followed to synthesise halichondrin B (**5**) and featured a Nozaki-Hiyama-Kishi coupling as one of the key steps. The reaction involves coupling of an alkenyl halide and an aldehyde in order to generate an alcohol, as shown in scheme 1.1. It is quite similar to the magnesium (0)-catalysed Barbier-type reaction but the Nozaki-Hiyama-Kishi (NHK) coupling doesn't use magnesium and so can tolerate ketones and esters in the presence of the aldehyde. In other words the NHK reaction tolerates a broader range of functionalities.

The NHK reaction was first reported in 1977 stating only the need for chromium (II) chloride. Concurrently, in 1986, both Kishi³⁰ and Nozaki³¹ reported that the effectiveness of the reaction was dependent on the source and batch of the chromium (II) chloride used. The reason for this was found to be that the effective batches possessed a trace quantity (~ 0.5 mol%) of NiCl₂ and the effectiveness of this reaction was dependent on this. The NHK reaction uses a substoichiometric quantity of NiCl₂ and this is needed in conjunction with stoichiometric quantities of CrCl₂.³²

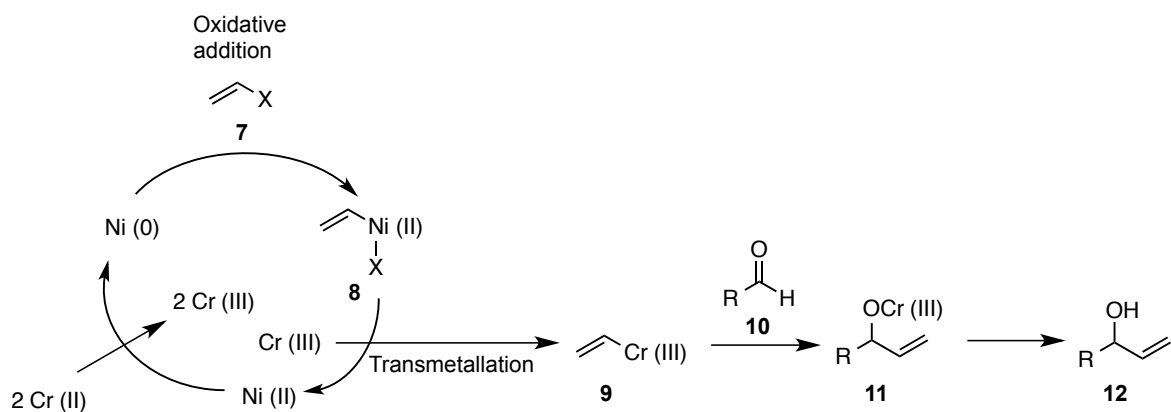

Scheme 1.1: Catalytic pathway for the Nozaki-Hiyama-Kishi coupling. Adapted from reference 31.

The NHK coupling reaction, shown in scheme 1.2, produced the secondary alcohol (**15**) in a 3:1 mixture showing that the reaction proceeds with some level of stereocontrol. The major stereoisomer that formed matched the desired stereochemistry needed for the tetrahydropyran formation seen in the next step. The tetrahydropyran was formed *via* an intramolecular Williamson ether synthesis with inversion of stereochemistry at CX.

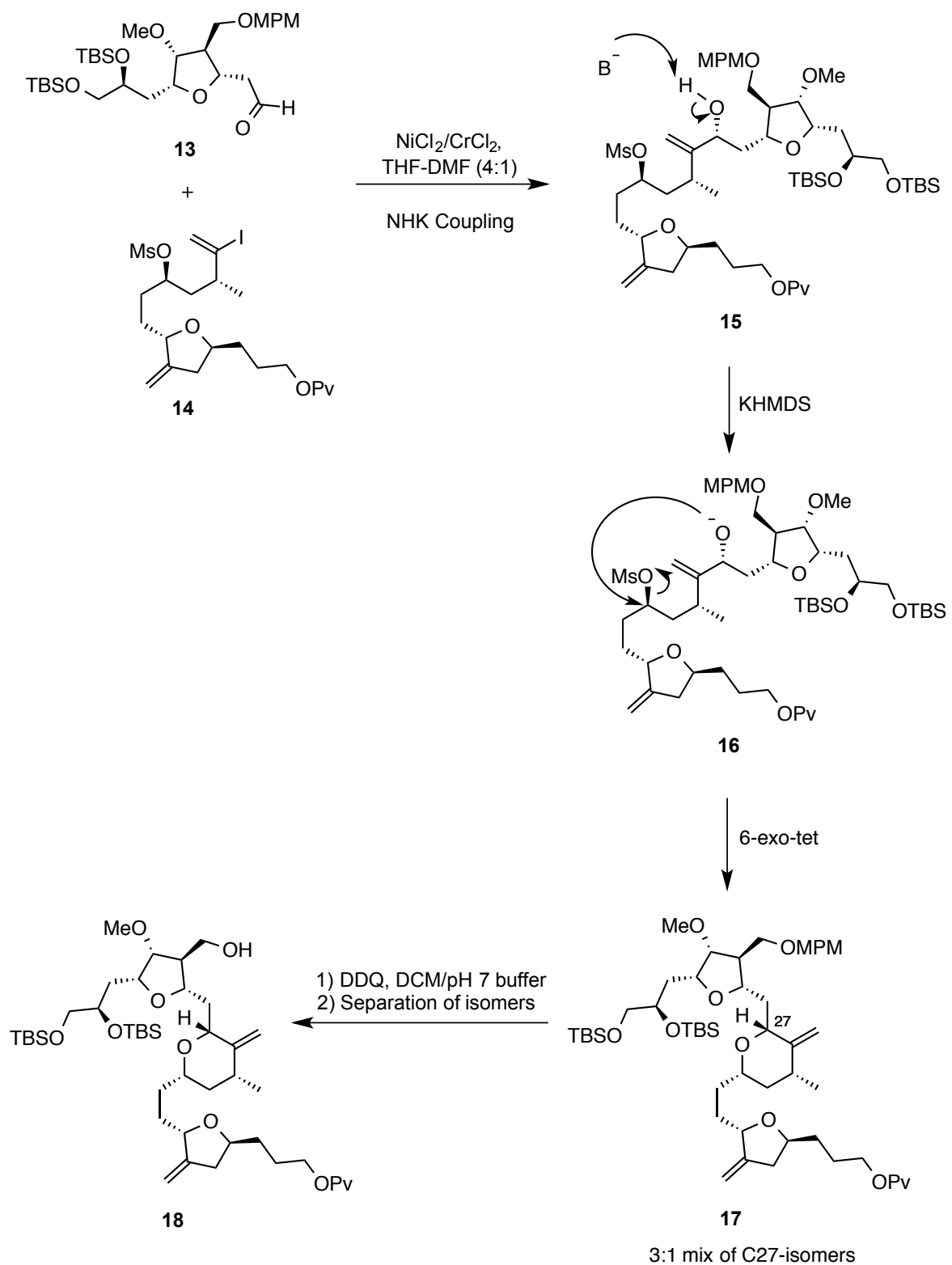

Scheme 1.2: Tetrahydropyran ring formation in the total synthesis of eribulin. Adapted from reference 26.

1.1.1.2. (-)-Centrolobine

Diarylheptanoid compounds that contain a tetrahydropyran ring have been shown to exhibit a variety of biological activities. One of these compounds is (-)-centrolobine (**19**).

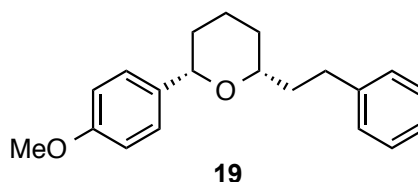

Figure 1.6: Structure of (-)-centrolobine.

This compound was isolated in 1964 from the heartwood of *Centrolobium robustum* and the stem of *Brosnium potable*, both from the Amazonian rainforest.³³ It has been shown to possess antibacterial activity, anti-inflammatory activity³⁴ and it also demonstrates activity against *Leishmania amazonensis promatigotes*, a parasite associated with leishmaniasis.

Leishmaniasis is a parasitic disease whose vector is the sandfly. In the human host the *Leishmania* protozoa attacks the body's spongiform organs (particularly the liver and the spleen).³⁵ The parasite can also attack the skin in cutaneous leishmaniasis. This gives rise to nodules and ulcers on the skin and symptoms are akin to leprosy.³⁶

The treatment for this disease over the past 80 years has been through the use of pentavalent antimonials (e.g. Sb(V) *N*-methyl-D-glucamine complexes); however

they have now been linked to both cardiac and renal toxicity. Hence new alternatives are required.³⁵

Centrolobine was first isolated in 1964 and successfully synthesised in 1965 as a mixture of stereoisomers.³⁷ Despite this success the first asymmetric synthesis of (-)-centrolobine (**19**) was not achieved until 2002.³⁸ This asymmetric synthesis (see Scheme 1.3) relied on the formation of a hydroxyketone (**28**) that could then cyclise to form the tetrahydropyran (**29**). The hydroxyketone was synthesised via the reduction of the corresponding β -ketosulfoxide (**23**) and the stereoselectivity is achieved due to the presence of the chiral sulfoxide and the use of zinc bromide as a complexing agent allowing for the directed complexation of diisobutylaluminium hydride (DIBAL-H) (**24**). The hydride is then intramolecularly transferred. The stereochemistry is a result of the aromatic group located on the sulfoxide group hindering the bromine-directed approach of DIBAL-H from one direction. This effect was described in 1990 by Solladié-Cavallo and co-workers using a catalytic quantity of zinc chloride.³⁹ Upon obtaining the secondary alcohol (**25**) it can then be converted to the Weinreb amide (**26**) before being reacted with *p*-methoxyphenylmagnesium bromide (**27**) to generate the desired hydroxyketone.

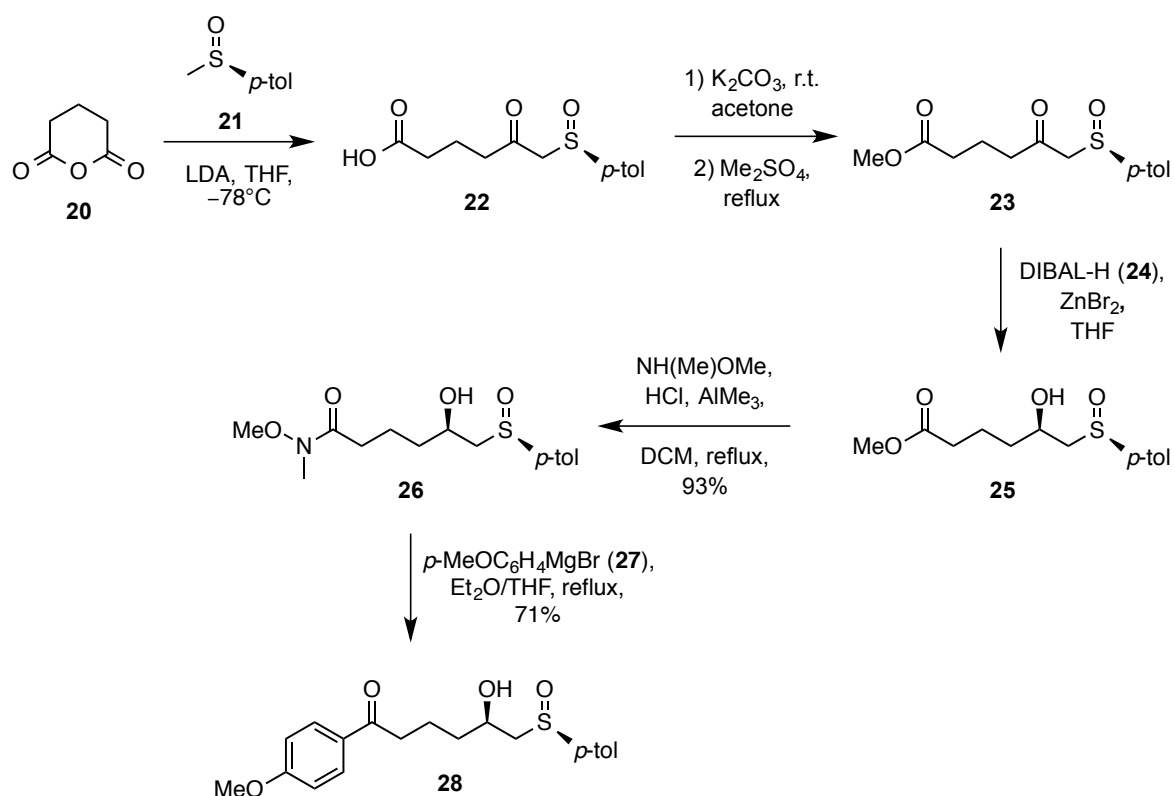

Scheme 1.3: Synthesis of hydroxyketone for use in the synthesis of (–)-centrolobine. Adapted from reference 38.

Upon obtaining hydroxyketone (**28**) the tetrahydropyran ring (**29**) could then be forged through treatment with an excess of triethylsilane and one equivalent of trimethylsilyl trifluoromethanesulfonate, as shown in scheme 1.4. The reaction proceeded at 0°C and, in 15 minutes, produced an 81% yield.

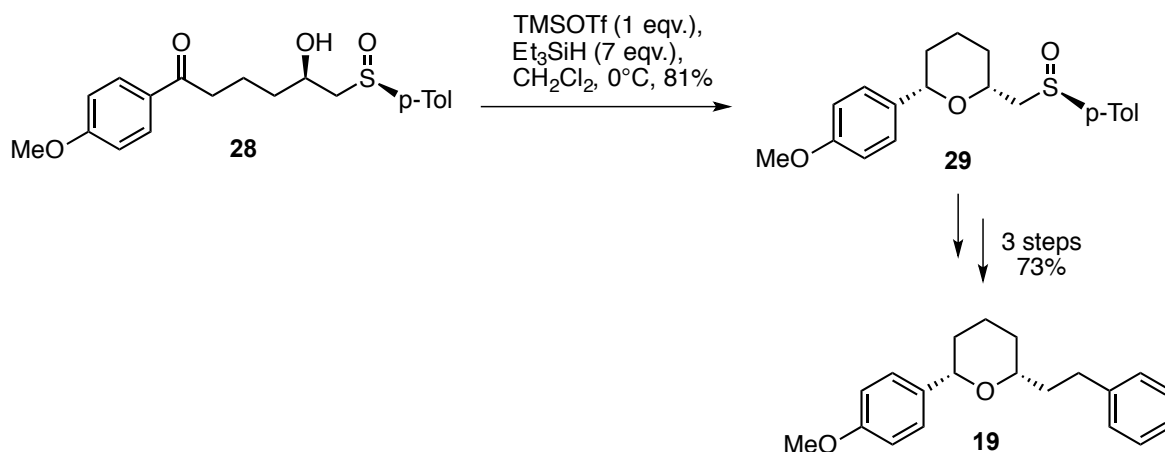

Scheme 1.4: Construction of the tetrahydropyran ring in the asymmetric synthesis of (-)-centrolobine. Adapted from reference 38.

1.1.1.3. Bryostatin 1

The family of compounds known as the bryostatins were first isolated from *Bugula neritina* in 1968⁴⁰ but it wasn't until 1982 that the structure of bryostatin 1 (**1**) was reported⁴¹ as a multiringed macrocyclic lactone – the structure of bryostatin 1 is shown in Figure 1.1.

Bryostatin 1 (**1**) possesses a variety of biological activities. It is a modulator of protein kinase C (a protein involved in the regulation of cell differentiation and cell proliferation); it has demonstrated usefulness in the treatment of Alzheimer's disease; in combinational therapy it could be used in a treatment against HIV²⁷ and it possesses antitumour properties. It's antitumour properties derive from the molecule's ability to:

1. Trigger the development of specific cytotoxic T-lymphocytes.
2. Activate and induce the proliferation of both T- and B-cells.

3. Stimulate T-cells to generate a number of cytokines, which includes IFN- γ and IL-2, two cytokines that have shown antitumour effects.⁴²

Although bryostatin 1 (**1**) has entered clinical trials with these properties, testing has not yet been completed. Bryostatin 1 (**1**) has also entered trials as a combinational therapy with paclitaxel (Taxol[®]) (**2**).⁸

In 2011, three new bryostatin total syntheses were reported in the literature with the shortest being 36 steps. One of these was the first synthesis of bryostatin 1 by Keck and co-workers in 58 steps.⁴³ The ability of chemists to synthesise these compounds in an efficient and low cost manner has led to the current push on the synthesis of these compounds and their analogues to generate more practical and effective drug candidates.

Efficient and stereoselective routes to the fragments of natural products is one way that this can be achieved, which is why stereoselective synthesis of tetrahydropyrans is so important and has been something that has been previously investigated by the group.

1.2. Tetrahydropyrans

The tetrahydropyran moiety is classed as a privileged scaffold and the function of the compounds it is found in are vastly different, depending on the array of functional groups located about the scaffold and their stereochemistry.

Examples (shown in Figure 1.7) include thyrensol A (**30**), thyrensol B (**31**), (+)-phorboxazoles A (**32**) and B (**33**), as well as leucascandrolide A (**34**). Thyrensols A (**30**) and B (**31**) were isolated from the red algae *Laurencia viridis* and possess cytotoxic activity against a number of human breast cancer cell lines.⁷ Both (+)-phorboxazole A (**32**) and (+)-phorboxazole B (**33**) are isolated from marine sponges (*Phorbas* sp.). They possess antibiotic and antifungal activity, along with possessing great cytotoxicity against a number of human cell lines. Their cytotoxicity is so great that it puts them in the same category as the halichondrin compounds (see section 1.1.1.) and the spongistatins.⁴⁴ Leucascandrolide A (**34**) possesses potent antifungal activity, inhibiting the growth of *Candida albicans*, a fungus known for causing yeast infections in humans. This tetrahydropyran-containing compound was isolated from the marine sponge *Leucascandra caveolata*.⁴⁵

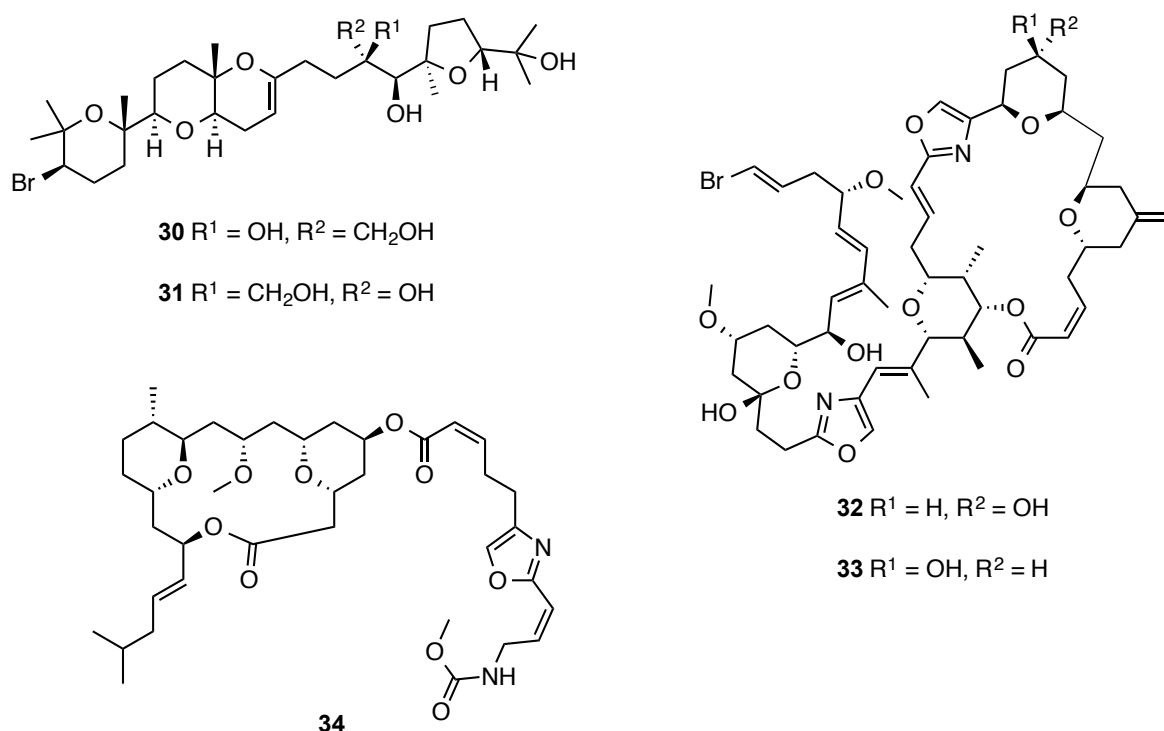

Figure 1.7: Examples of biologically active, tetrahydropyran-containing natural products.

Another common privileged scaffold is the piperidine motif. Entities possessing this structure are currently important targets in pharmaceutical research.⁴⁶ Since 1993 there have been four commercial drugs developed that contain this moiety.⁴⁷

1. Donepezil (**35**) (Aricept™) – an acetyl cholinesterase inhibitor that is used in the treatment of Alzheimer’s disease.
2. Naratriptan (**36**) (Amerge™ and Naramig™) – used in the treatment of migraines.
3. Risperidone (**37**) (Risperdal™) – used in the treatment of schizophrenia.
4. Sertindole (**38**) (Serdolect™ and Serlect™) – used in the treatment of schizophrenia.

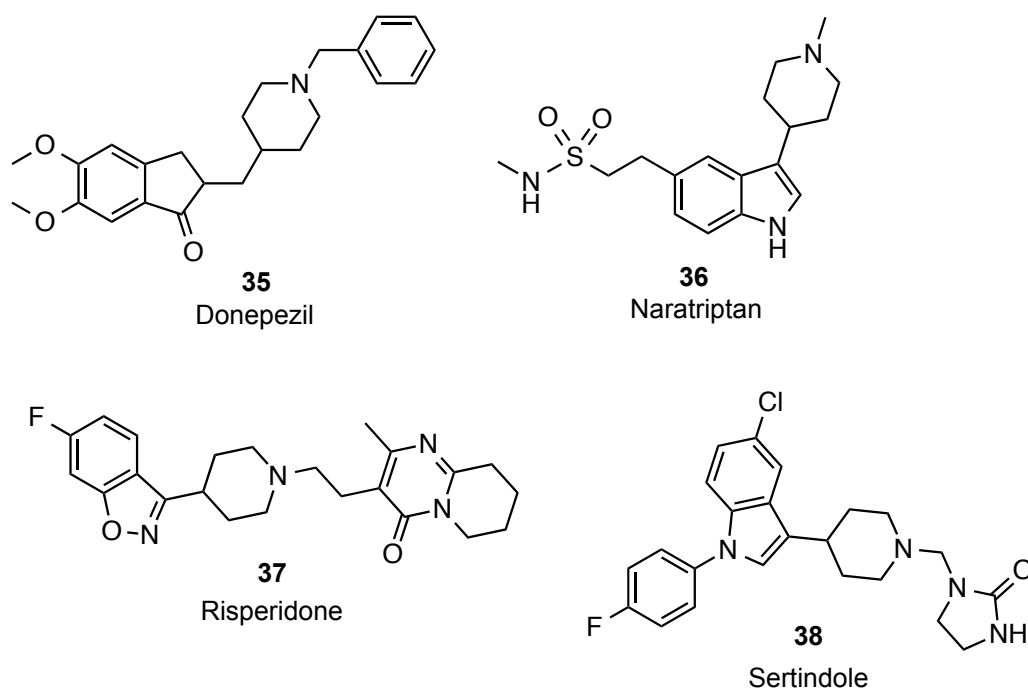

Figure 1.8: Pharmaceuticals developed since 1993 that contain the piperidine moiety. Adapted from reference 47.

Whether looking at tetrahydropyrans or piperidines, the importance of stereochemistry cannot be denied. Due to this, new stereoselective synthetic methods are of great importance.

A number of strategies have been developed in the stereoselective synthesis of tetrahydropyrans. Some of the more commonly used techniques include: the Prins cyclisation, oxy-Michael reaction and the hetero-Diels-Alder reaction.

1.2.1. Strategies used in the Stereoselective Synthesis of Tetrahydropyrans

1.2.1.1. Tetrahydropyran Synthesis – Prins Cyclisation

The Prins cyclisation is a method that can synthesise functionalised oxygen-containing heterocycles such as tetrahydropyrans, dihydropyrans and tetrahydropyranones. The reaction is acid catalysed, under thermodynamic control and takes place between an aldehyde and a homoallylic alcohol.⁴⁸ In terms of tetrahydropyran synthesis it is one of the most versatile methods available.⁴⁹

Kriewitz performed the initial work investigating the condensation of alkenes with aldehydes in 1899.⁵⁰ From this work he discovered that unsaturated alcohols could be produced upon heating paraformaldehyde with pinene (a bicyclic monoterpene). Prins began a comprehensive study of the reactions between formaldehyde and various alkenes and this work was reported in 1919.⁵¹

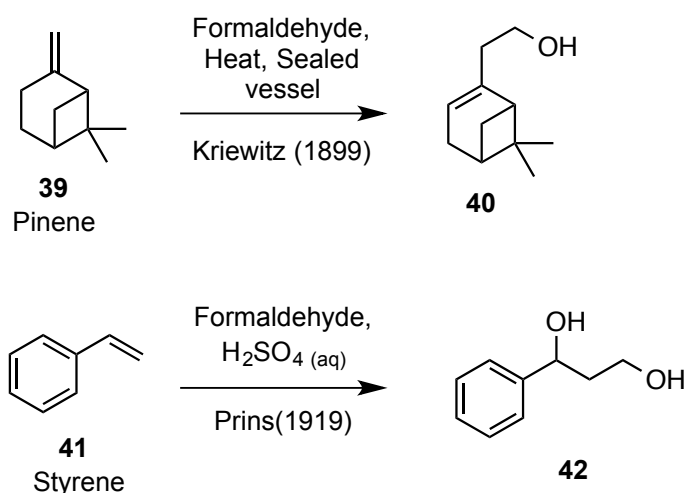

Scheme 1.5: Initial studies leading to the development of the Prins cyclisation. Adapted from reference 51.

When first investigated, the reaction used sulfuric acid and heating, giving a number of unwanted side products. Since the discovery of the reaction and its application to the synthesis of tetrahydropyrans an array of Brønsted and Lewis acid catalysts have been tested and successfully applied.⁵²

The Prins cyclisation generates, *in situ*, an oxocarbenium ion (**47**). After computational studies by Alder⁵³ it was found that this ion preferentially adopts the *E*-geometry.⁴⁸ The oxocarbenium ion undergoes an intramolecular cyclisation that produces the ring structure with substituents located in the equatorial positions. A nucleophile can be used to trap the carbocation formed giving the tetrahydropyran product.⁵⁴

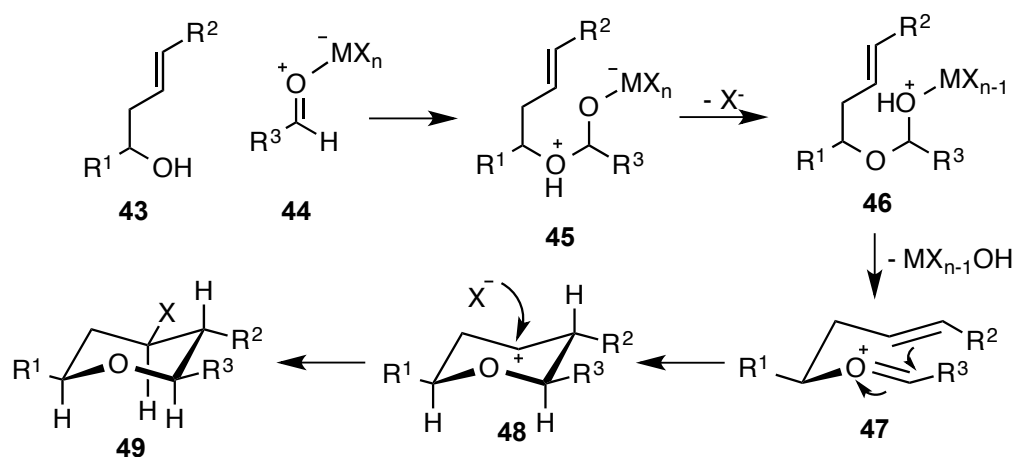

Scheme 1.6: Generalised Prins cyclisation. Adapted from reference 51.

Despite its synthetic usefulness there are a number of limitations to the Prins cyclisation:

1. A stoichiometric quantity of the acid is needed.⁴⁹
2. Generally a halide is used to trap the carbocation.

3. If an electron-rich aromatic ring is seen adjacent to the alcohol then the reaction suffers from solvolysis of the alcohol, a number of side products are seen and the competing oxonia-Cope rearrangement is seen.⁵⁵

The competing oxonia-Cope rearrangement is one of the biggest problems seen when using the Prins cyclisation.

Typically the oxonia-Cope rearrangement is seen when there is an electron-rich aromatic ring present in the homoallylic alcohol. This is because the electron-donating ability of the ring provides stability to the carbocation that forms through conjugation.⁵⁶ When the aromatic ring possesses electron withdrawing substituents then this is not the case and the oxonia-Cope product is not seen.⁵⁴

Whether the oxonia-Cope rearrangement occurs or not the oxocarbenium ion is able to proceed to the desired tetrahydropyran (**54**), but if the [3+3]-oxonia-Cope rearrangement has taken place then loss of absolute stereochemistry is seen. This means that when the tetrahydropyran is formed it is a mixture of stereoisomers due to racemisation seen with the oxonia-Cope intermediate.⁵⁷ As well as proceeding to the tetrahydropyran, the rearranged oxonia-Cope ion can fragment in an allyl transfer process giving a new aldehyde (**56**) and a new homoallylic alcohol (**57**). This newly formed homoallylic alcohol can react with the initial aldehyde (**10**) to give a symmetrical tetrahydropyran (**58**), which was not desired. The nucleophile used (in this case Cl⁻) can also react with the carbocation forming the side product **53**.⁵¹

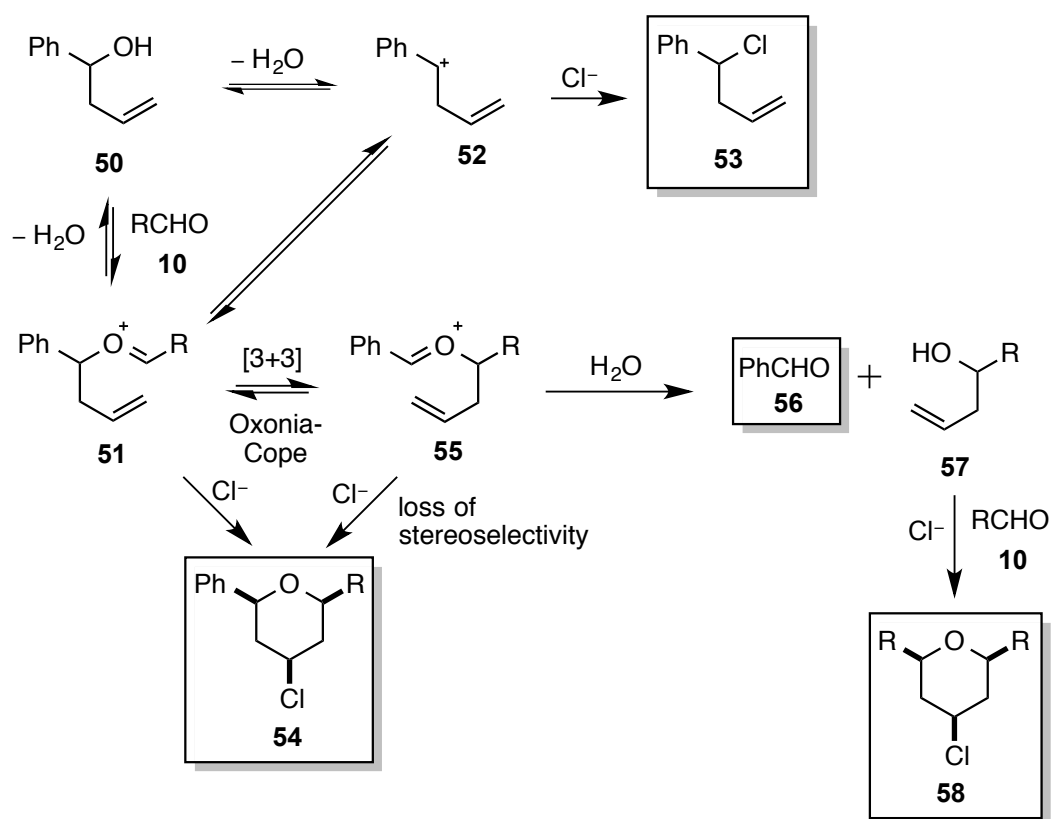

Scheme 1.7: Prins cyclisation where an electron-rich aromatic ring is adjacent to the alcohol. The competing oxonia-Cope rearrangement is shown also. Adapted from reference 59.

The Prins cyclisation has received much attention in the literature and one area of research that has been focused on is methods by which the competing oxonia-Cope rearrangement can be minimised. Rychnovsky reported on one such development in 2002. This involved cyclisation of an α -acetoxy ether using a Lewis acid.⁵⁵ Initially the reaction was conducted using BF_3 , however, the competing oxonia-Cope rearrangement was seen giving partial racemisation (87% e.e. to 68% e.e.). The Lewis acid used was changed from BF_3 to SnBr_4 . With this reaction there was very little of the competing oxonia-Cope product seen (87% e.e. to 85% e.e.). This is because the Prins cyclisation occurred at a much more rapid rate and hence the competing reaction was suppressed.⁵⁵ A lower

temperature was also used for this reaction and, based on the Maxwell-Boltzmann distribution, this may have contributed to the suppression of the competing reaction.

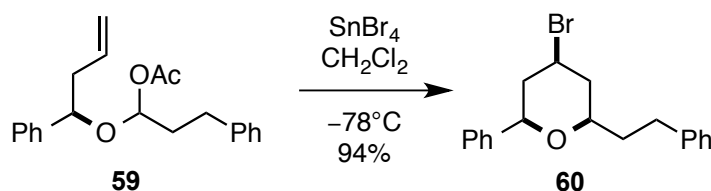

Scheme 1.8: Rychnovsky's tetrahydropyran formation from the corresponding α -acetoxy ether. The competing oxonia-Cope rearrangement is minimised due to the rapid rate of the reaction when employing SnBr_4 as the Lewis acid. Adapted from reference 55.

Many of the developments of this reaction have focused on looking at different catalysts which can be used (e.g. iodine).⁵⁸ One particularly effective class of catalysts were the indium halides.⁵¹ This was first developed to synthesise 4-halo tetrahydropyrans in good yield. It was taken further by Loh by including another halogen atom in the starting compound. This allowed the synthesis of 2,4,5,6-tetrasubstituted tetrahydropyrans where positions 4 and 5 both have halo-substituents.⁵⁹

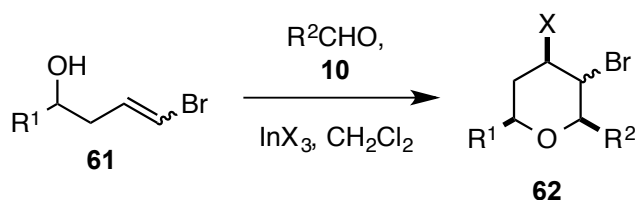

Scheme 1.9: Loh's indium-catalysed formation of 2,4,5,6-tetrasubstituted tetrahydropyrans. Adapted from reference 59.

Loh discovered that by controlling the geometric configuration of the γ -brominated homoallylic alcohol, the stereochemistry at the C5 position (bearing a bromine substituent) in the tetrahydropyran could be effectively manipulated. The two R groups present maintained a *cis*-relationship and in both cases were located in the equatorial positions, as was the bromine substituent in the C4 position.⁵⁹ This is shown in Scheme 1.10.

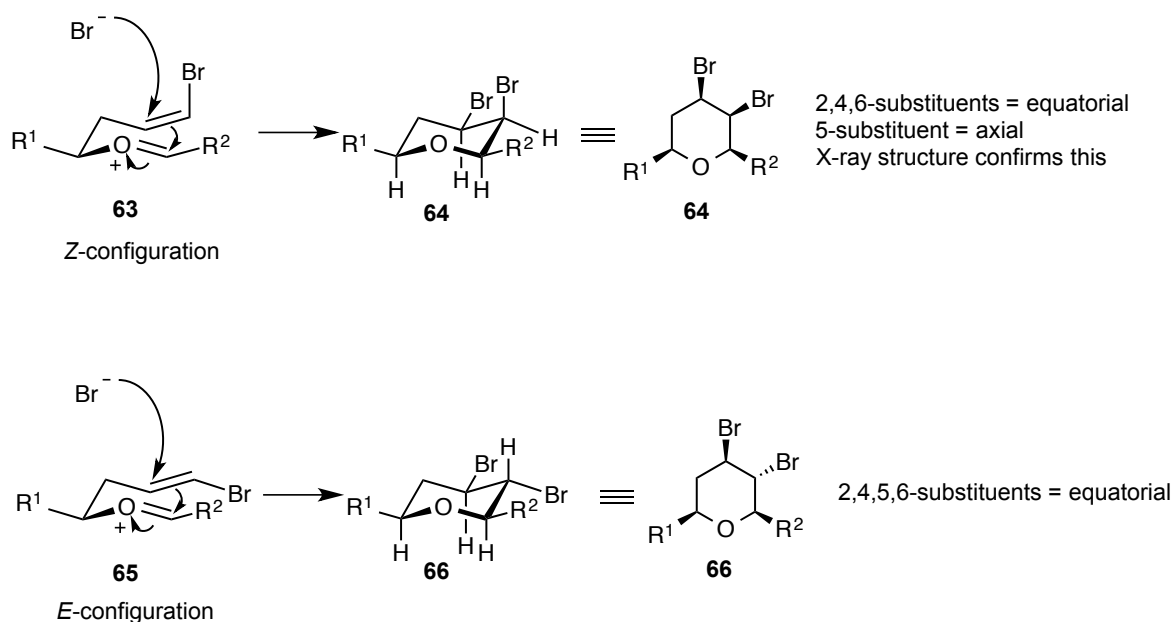

Scheme 1.10: Mechanism explaining the stereochemical outcome seen in Loh's formation of 2,4,5,6-tetrasubstituted tetrahydropyrans. Adapted from reference 59.

The Prins cyclisation has been utilised in a number of syntheses towards natural products and biologically active compounds.⁶⁰ One of these is Maier's approach to the synthesis of the neopeltolide macrolactone (**72**).⁶¹ This was completed using trifluoroacetic acid (TFA), and the role of this acid was two-fold. It both promoted the oxonium ion formations and also acted as the nucleophile that quenches the tetrahydropyranyl cation. This reaction proceeded in high yield (72%) and a small

quantity of an alternate stereoisomer was seen that possessed the trifluoroacetoxy group in the axial position (8:1 major:minor ratio).⁶²

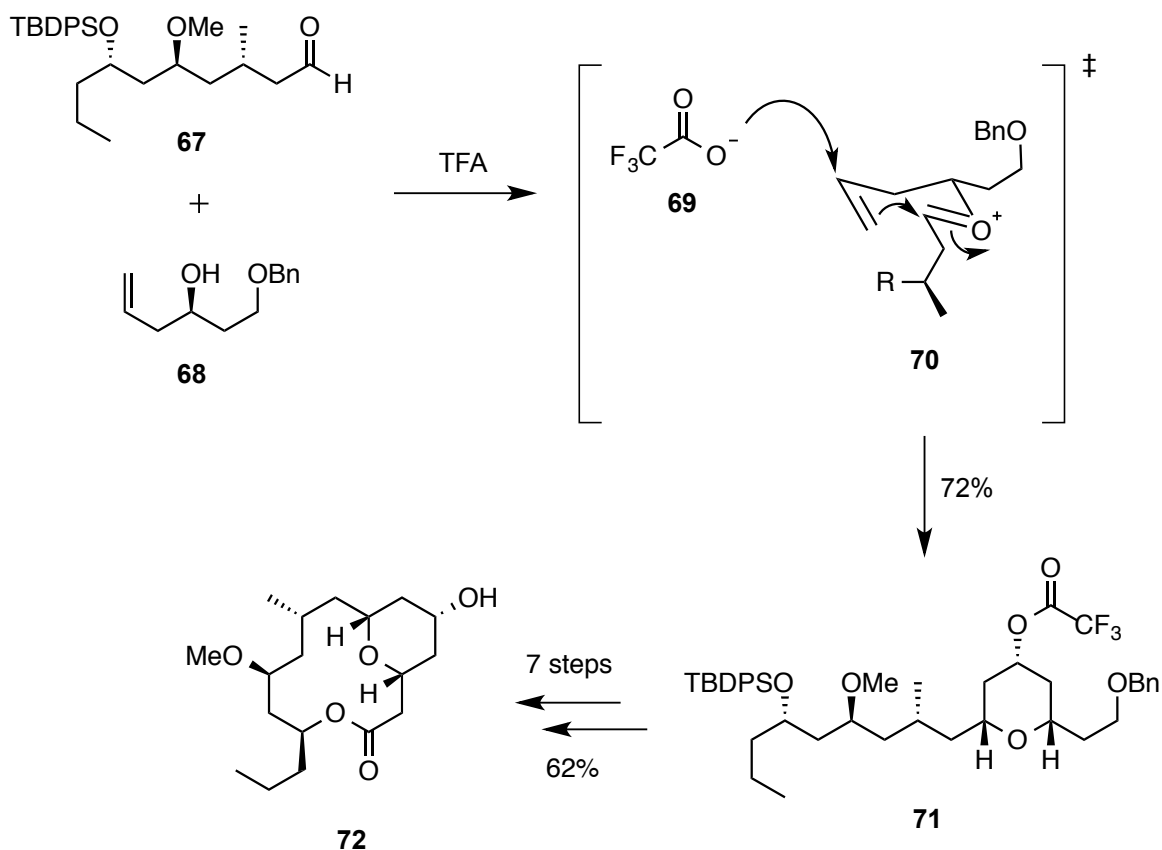

Scheme 1.11: Maier's synthesis of the neopeltolide macrolactone utilising the Prins cyclisation.

Adapted from reference 61.

1.2.1.2. Tetrahydropyran Synthesis – Hetero-Michael Reaction

A Michael reaction, the addition of a carbon nucleophile to a conjugate acceptor system, is one of the most versatile and widely used reactions in organic synthesis, and tremendous progress has been made in increasing the reaction's scope, rate and stereoselectivity. Hetero-Michael reactions however, have received much less attention until recent years, which is surprising given that the first oxy-Michael addition was published by Loydl in 1878.⁶³ The oxy-Michael

reaction (reaction of an oxygen nucleophile with a conjugate acceptor system) is now garnering more interest and has shown to be a useful technique in the synthesis of functionalised tetrahydropyrans.

There are two main drawbacks to oxy-Michael additions. The first is the reversibility when the oxygen nucleophile adds to the conjugate acceptor. The second is the low reactivity of the oxygen nucleophile. In order to increase the nucleophilicity the alcohol can be deprotonated by a strong base (such as potassium *tert*-butoxide).⁶⁴ Another way to overcome this issue is to activate the conjugate acceptor system using a Brønsted or Lewis acid or by use of a transition metal complex.⁶⁵ In some cases these conditions are incompatible with other functionalities located within the compound. Another drawback to this reaction is that a pre-existing chiral centre is required, but the use of a transition metal catalyst is such an effective technique in the production of chiral alcohols, that this drawback is generally overcome.⁶⁶

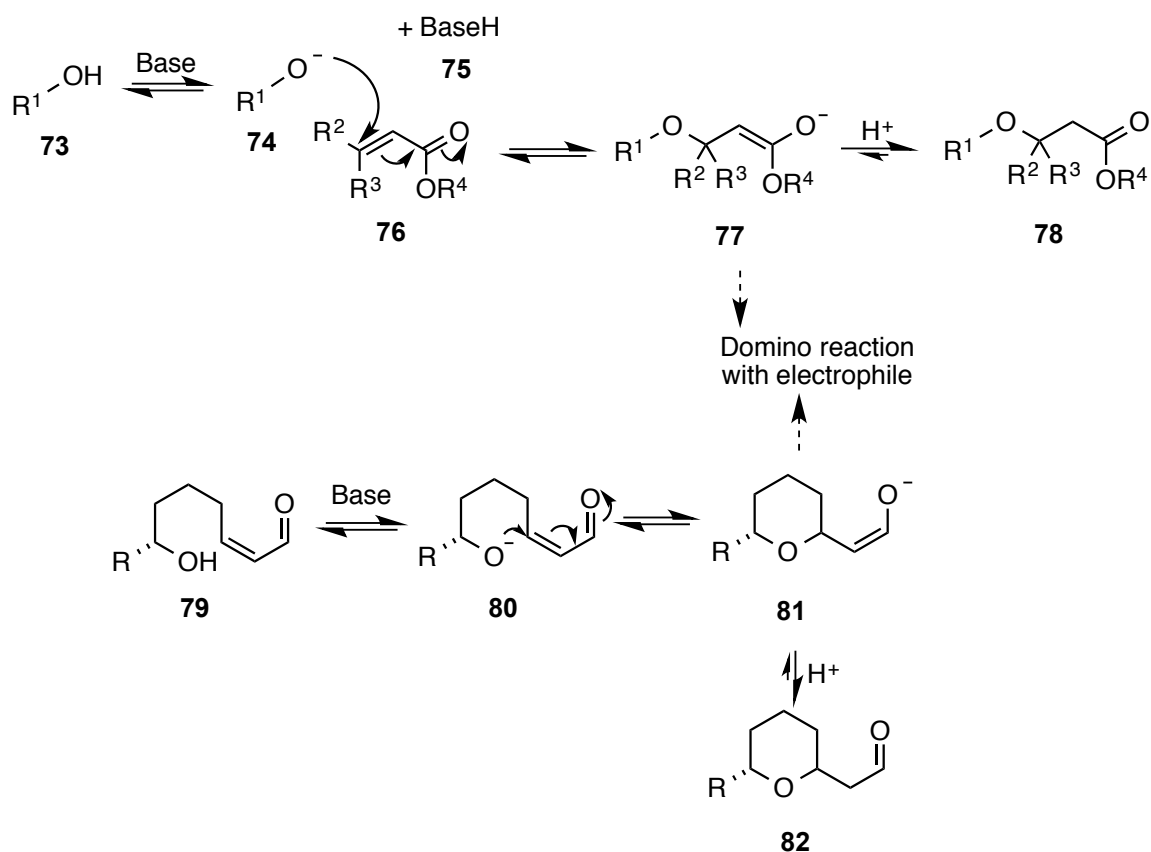

Scheme 1.12: Generalised oxy-Michael addition. Top – Intermolecular, acyclic example. Bottom – Intramolecular, cyclic example.

Once the base has been used to deprotonate the oxygen nucleophile then this reacts with the Michael acceptor to generate the enolate anion (**77** and **81**). This can then regenerate the carbonyl group and react with either H^+ or can undergo a domino reaction with an electrophile.

The stereochemical outcome of these cyclisation reactions is influenced by the double bond geometry of the Michael acceptor. In 1997, Banwell reported on hetero-Michael reactions and how both the *cis*- and *trans*-2,6-disubstituted heterocycle could be obtained by controlling the double bond geometry. This relies on the metal that is present in the basic reaction as this chelates to stabilise the

two partially negatively charge oxygen atoms.⁶⁷ This work has been supported by White when using the oxy-Michael addition⁶⁸ and also by Martín.⁶⁹

The transition state seen with (*E*)-double bond geometry favours the ester substituent being located in the axial position. This is because it allows for chelation with the metal ion. If the (*E*)-double bond is located in the equatorial position then the partially negative carbonyl oxygen is unable to chelate to the metal due to distance. This favours the *trans*-tetrahydropyran. The transition state with (*Z*)-double bond geometry favours the equatorial position as it allows chelation for the metal that is not seen if the (*Z*)-double bond is located in the axial position. This is demonstrated in Figure 1.9.

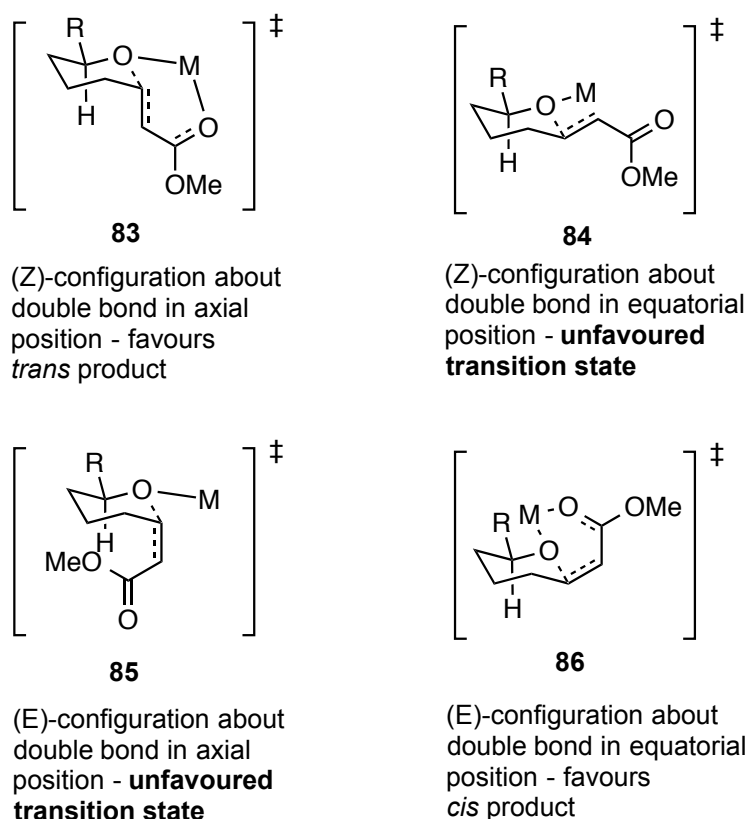
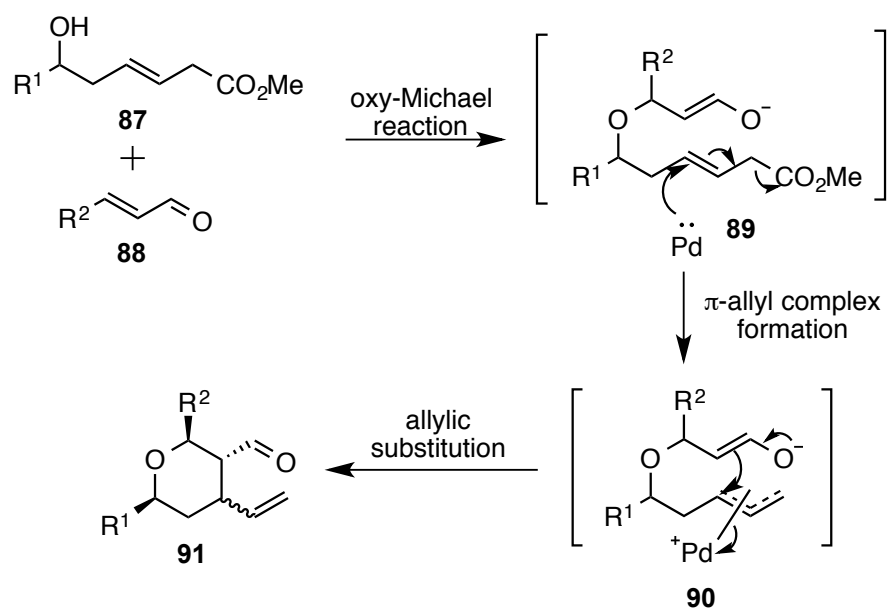

Figure 1.9: Transition states showing how double bond geometry affects the stereochemical outcome of the oxy-Michael reaction. Adapted from reference 70.

As shown in Scheme 1.12 it is possible to use the potent nucleophilicity of the enolates formed via this reaction in additional reactions with suitable electrophiles in a domino process. One way of doing this, which was exploited by Menche and Wang in 2012, is to combine the oxy-Michael reaction with a Tsuji-Trost coupling (the allylation of nucleophiles with allylic compounds, catalysed by palladium).⁷¹ This is an effective process to synthesise highly functionalised tetrahydropyrans from homoallylic alcohols. The palladium catalyst can form a π -allyl complex (**90**). This generates an electrophile that is able to react with the previously generated enolate via an intramolecular allylic substitution reaction.



Scheme 1.13: Combining the oxy-Michael addition and the Tsuji-Trost coupling. Adapted from reference 65.

Due to its versatility the oxy-Michael addition has been used to construct the tetrahydropyran motif in a number of natural products such as leucascandrolide A (**34**),⁷² aspergillides A and B,⁷³ as well as spongistatin 1 (**95**).⁷⁴ One of the issues seen in the synthesis of spongistatin 1 (**95**) was that upon completion of the oxy-

Michael reaction under basic conditions a 1:1 mixture of diastereoisomers was seen varying at the C43 position. This comes from the fact that the double bond geometry in the tetrahydropyran precursor was in the (*E*)-geometry as shown in Figure 1.9. The tetrahydropyran diastereoisomer mixture was allowed to equilibrate under basic conditions and, after twenty hours, the all-equatorial substituted tetrahydropyran was seen in a 95:5 diastereomeric ratio.⁷⁴

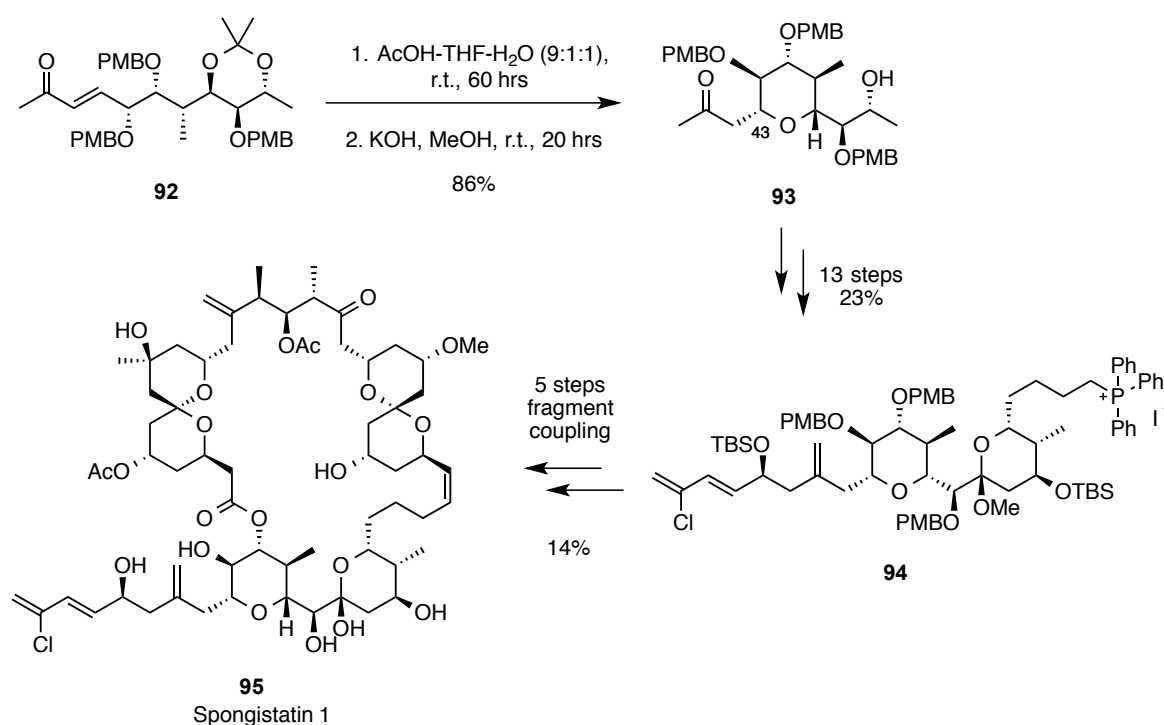

Scheme 1.14: Use of the oxy-Michael reaction in the synthesis of a tetrahydropyran in the EF segment of spongistatin 1. Adapted from references 74 and 75.

1.2.1.3. Tetrahydropyran Synthesis – Hetero-Diels-Alder reaction

The Diels-Alder reaction is a powerful, versatile technique, with several asymmetric variants, that is widely known and utilised in the synthesis of six-membered rings with high levels of regio- and stereoselectivity.⁷⁶ A variant on this

is the hetero-Diels-Alder (HDA) reaction.⁷⁷ This allows the construction of heterocycles and is one way to construct substituted tetrahydropyrans.⁷⁸

In 1982, Danishefsky and co-workers extended the scope of the HDA to include unactivated aldehyde heterodienophiles through the use of a Lewis acid catalyst.⁷⁹ Since then the reaction has garnered much attention because it provides an easy route to the synthesis of dihydropyrans and pyranone products. These are important intermediates in the synthesis of a range of multi-substituted tetrahydropyrans. The Lewis acid catalyst binds to the carbonyl group of the aldehyde and lowers the energy level of the lowest unoccupied molecular orbital (LUMO) accounting for the enhancement to the reaction rate.⁸⁰

Metal ions can also play a part in affecting the stereochemical outcome of the product due to chelation. By including MgBr_2 (0.2 eqv.) Luger and co-workers were able to product the *trans* pyranone (**101**) instead of the *cis* pyranone (**99**) that was seen as the major product under thermal conditions.⁸¹

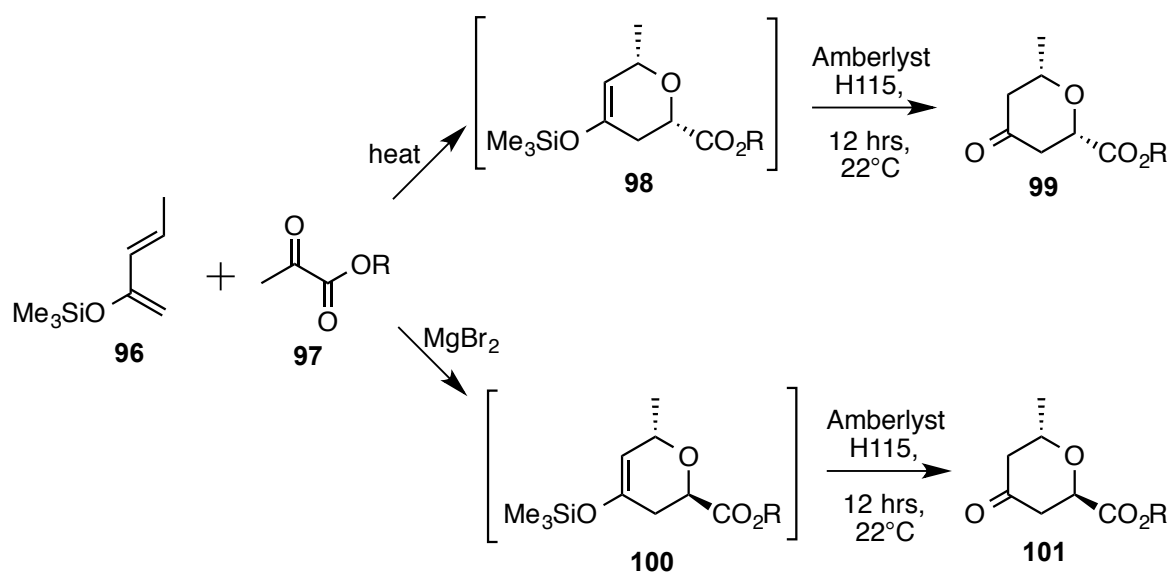

Scheme 1.15: Metal chelation affecting the stereochemical outcome of the HDA reaction. Adapted from reference 81.

This is because the *exo*-transition state is less hindered than the *endo*-transition state. The *endo*-transition state exhibits an unfavourable interaction between one of the bromine atoms and the carbon skeleton of the diene.

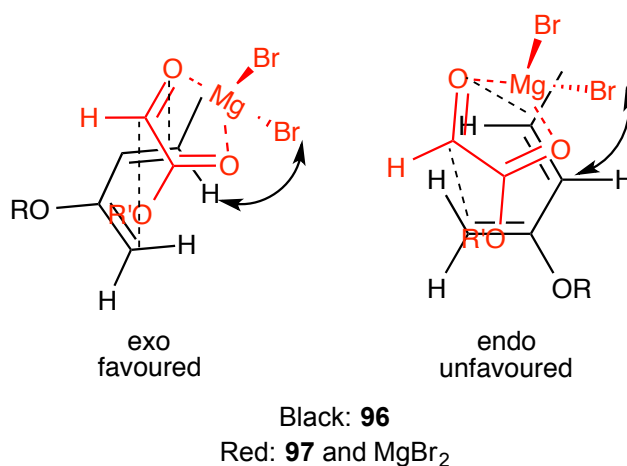
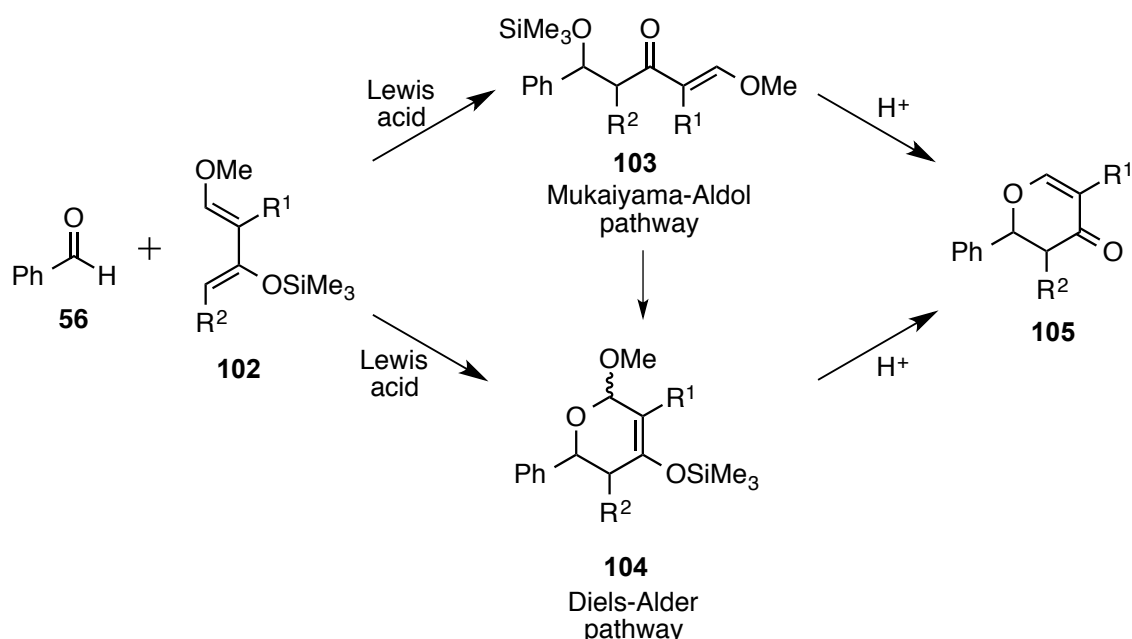

Figure 1.10: *Exo* and *endo* transition states of Luger's hetero-Diels-Alder reaction. Adapted from reference 81.

When an activated diene is used in the HDA reaction, such as the Danishefsky-type dienes (**102**), then the reaction may proceed through one of two routes. The route that is followed is dependent on the chiral Lewis acid catalyst that has been employed. These two routes are the Mukaiyama-Aldol pathway and the Diels-Alder pathway. The Mukaiyama-Aldol intermediate (**103**) is able to undertake a ring closure to give the HDA-adduct **104**.



Scheme 1.16: An activated diene being used in the HDA reaction – both reaction pathways are shown. Adapted from reference 82.

Jørgensen demonstrated that chiral Lewis acids possessing oxygen atoms (e.g. $(MeO)_2AlMe$) are important to stabilise the Mukaiyama-Aldol intermediate (**103**). Without this stabilisation the Diels-Alder pathway is preferred; however the Mukaiyama-Aldol intermediate is still able to cyclise to the HDA adduct **104**.⁸²

The Jacobsen group have reported HDA reactions using less nucleophilic dienes and unactivated carbonyl compounds, therefore giving the reaction greater scope. This is done using a chromium (III) catalyst such as the tridentate Schiff base chromium (III) complex **106**.⁸³

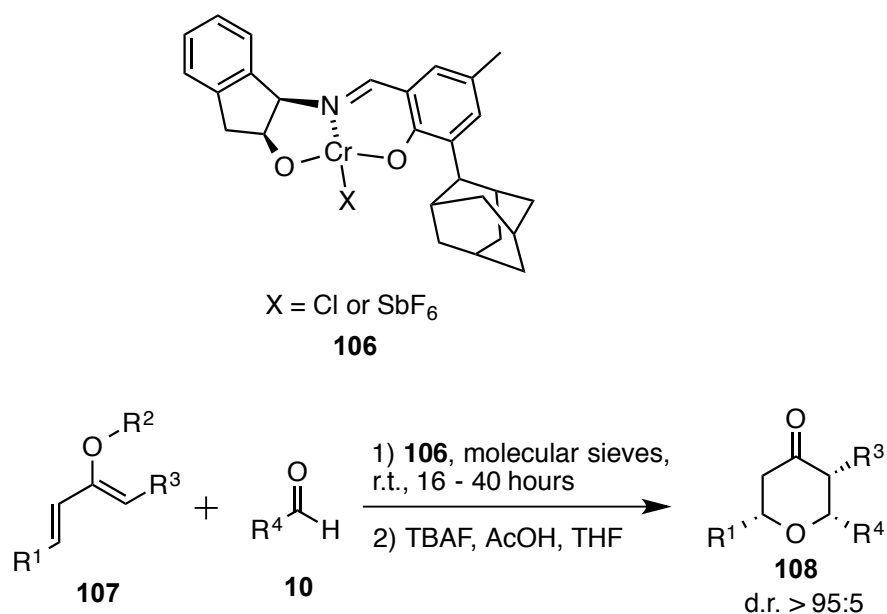

Scheme 1.17: Jacobsen's development to HDA reactions using a tridentate Schiff base chromium (III) complex. Adapted from reference 109.

This has not been the only catalyst developed for the HDA reactions. Another catalyst is the copper BOX-complex **109**.

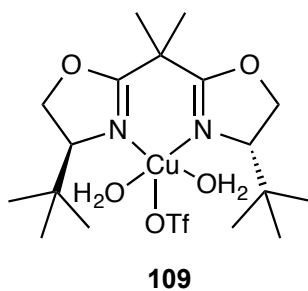
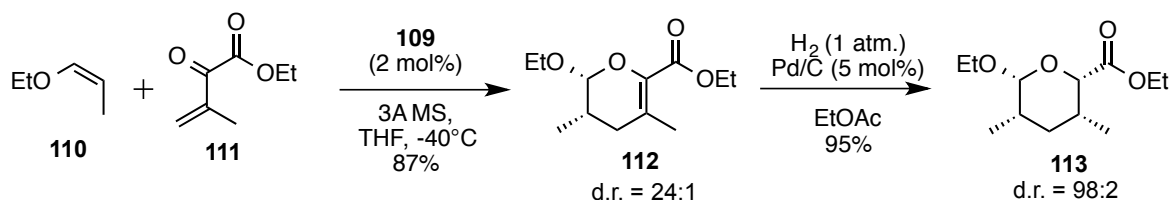

Figure 1.11: Copper BOX-complex catalyst. Adapted from reference 84.

This catalyst was used in a HDA reaction that was part of the synthesis of one of the rings located in the shellfish toxin (+)-azaspiracid. The HDA produced the dihydropyran, which was reduced to the corresponding tetrahydropyran (**113**).⁸



Scheme 1.18: A HDA reaction employed in the synthesis of (+)-azaspiracid. Adapted from references 85 and 86.

1.2.1.4. Tetrahydropyran Synthesis – Transition Metal Catalysed Reactions

It is possible to synthesise tetrahydropyrans *via* metal-catalysed C-O bond formations. A variety of transition metal catalysts have been used in this process, where the metal being used depends on the functionalities involved in the starting compound.

Palladium is a commonly used catalyst when cyclising δ -hydroxyalkenes that possess an allylic leaving group. In this process the ability of Pd(0) to form allylic complexes is exploited.⁸⁷ When using Pd(0) the palladium preferentially coordinates to the less hindered face of the double bond forming the π -allylic complex. The δ -hydroxyl group then traps this intramolecularly, adding on the face opposite the palladium, forming a C-O bond *via* a favoured 6-exo-ring closure process. This means that the stereochemistry of the product is governed by the leaving group's stereochemistry.

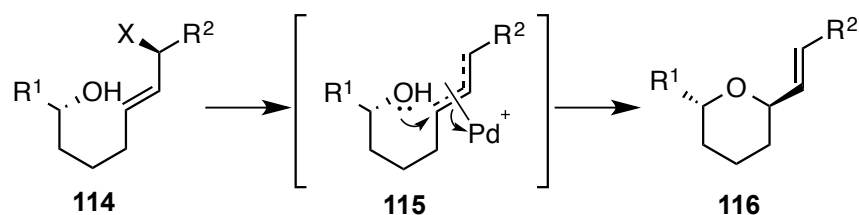

Scheme 1.19: Generalised Pd(0) catalysed ring closure. Adapted from reference 87.

Work of this type (i.e. forming tetrahydropyrans through a Pd (0) catalysed reaction) was initially completed by Trost in 1988.⁸⁸ This work made use of allyl acetates that possessed a remote vicinal diol (**117**). This was subjected to the cyclisation conditions and the work focused on the ring size that would preferentially form. The stereochemical aspects were not explored.

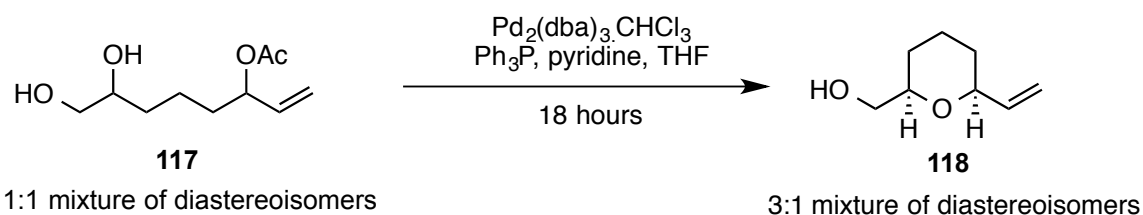

Scheme 1.20: Trost's work on palladium-catalysed chemoselective cyclic ether formation. Adapted from reference 88.

The diastereoisomer mix seen as the product from Trost's work begins as a 1:1 mix of diastereoisomers after 6 hours. It is only upon leaving for a longer length of time that the higher diastereomeric ratio is seen suggesting that over time the reaction is under thermodynamic control. Initially the reaction is under kinetic control generating the 1:1 ratio seen.

In 2008 the reaction shown in Scheme 1.19 was also catalysed using a gold catalyst by Aponick.⁸⁹ Gold has only recently begun to be used as it was previously assumed to be inert.⁹⁰ However Au(I) catalysts can co-ordinate to C-C π -bonds, activating them towards nucleophilic attack.⁹¹

Gold catalysts can also be used in the synthesis of tetrahydropyrans and piperidines from homopropargylic ethers (**119**). This synthesis combines two gold-catalysed transformations.⁹⁰ The homopropargylic ether (**119**) undergoes a gold-catalysed addition of water, followed by the elimination of methanol. The intramolecular 1,4-addition that follows involving the alcohol or amine is also gold-catalysed.

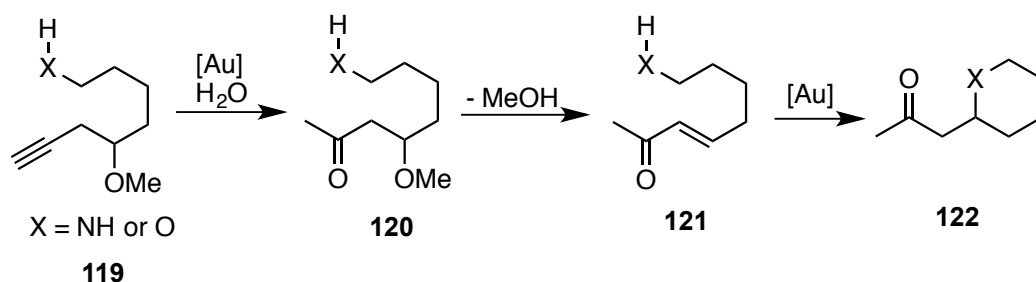

Scheme 1.21: Gold-catalysed reaction of homopropargylic ethers. Adapted from reference 90.

Platinum catalysts have received attention from Widenhoefer who looked at the intramolecular addition of a hydroxyl group to a pendant alkene.⁹¹ This process has been shown to tolerate a number of functionalities (such as amides or silyl and benzyl ethers) and works in a manner similar to that shown in Scheme 1.19 where the platinum catalyst forms a π -allylic complex, increasing its electrophilicity and so activating it towards nucleophilic attack.

Palladium (II) compounds form pyrans differently than Pd (0) and other related catalysts. The Pd (II) compound co-ordinates to the carbon-carbon double bond forming a π -complex. The electrophilic nature of Pd (II) means that there is a decrease in electron density about the alkene bond allowing it to be attacked by a nucleophile.⁹²

Uenishi employed this in the total synthesis of (-)-laulimalide (**127**).⁹³ When it came to forming the pyran ring both Pd (0) and Pd (II) complexes were tested (on slightly altered starting materials). In both cases the stereoselectivity of the reaction matched but the reaction using Pd (II) gave a higher yield – 89% rather than 59%. The stereoselectivity when using Pd (II) comes from the possibility of nucleophilic attack from either the *re* or *si* face.

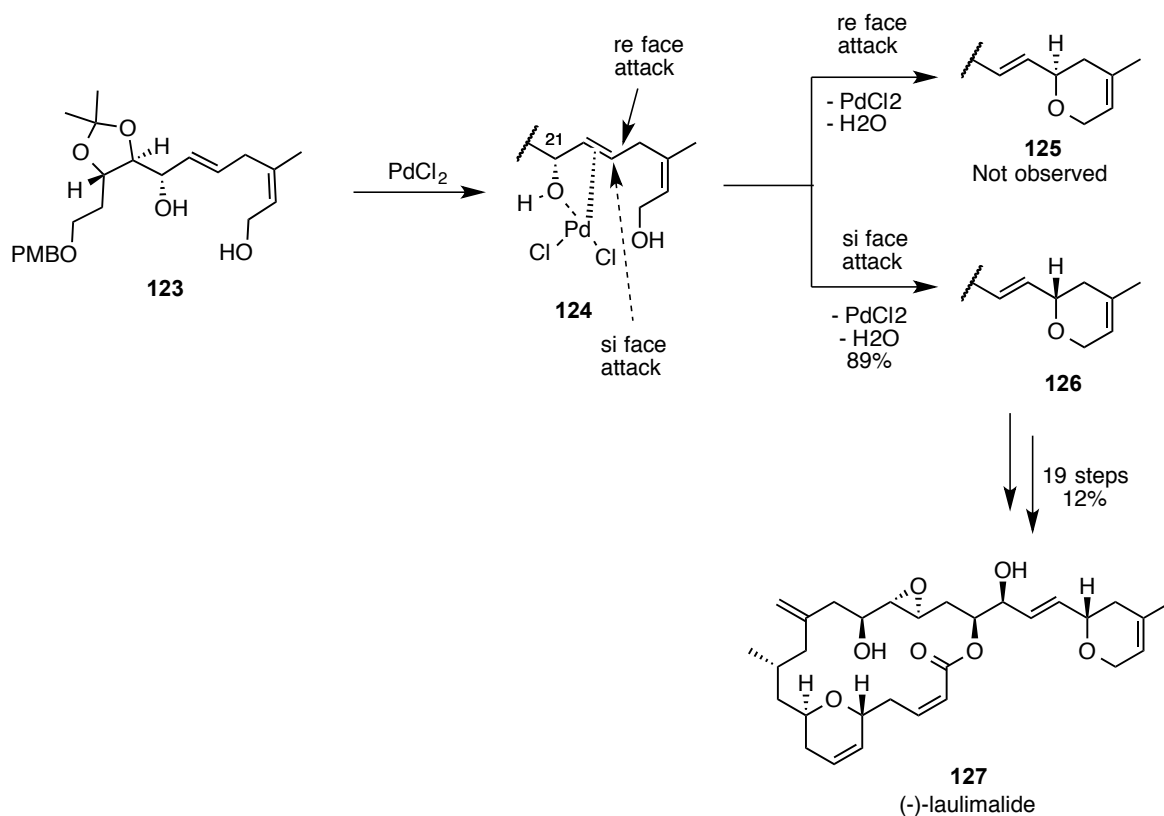

Scheme 1.22: (-)-laulimalide synthesis utilising palladium (II). Adapted from reference 95.

The palladium π -complex forms on the same face as the hydroxyl group located on C21. An internal *syn*-S_N2'-type reaction then takes place with the nucleophilic hydroxyl group attacking from the same side of the complex (in the case of **124** on the *si* face). If the C21 hydroxyl group is located in front of the plane of the molecule, the complex will form on the other side of the molecule from that shown in **124**, and so the nucleophilic hydroxyl group will attack from the *re*-face. In that scenario only stereoisomer **125** is observed.⁹³

1.2.1.5. Tetrahydropyran Synthesis – Ring Closing Metathesis

Ring closing metathesis (RCM) is a widely used tool in the formation of carbon-carbon bonds. It is a technique that has been used in the construction of tetrahydropyrans and piperidines.⁹⁴ This is due to the mild conditions the reaction requires, high product yields, stereochemistry retention and excellent compatibilities with a range of functionalities. During the reaction the stereocentres do not change and this gives rise to the retention of stereochemistry. This means that the stereochemistry seen in the starting material is seen in the product.⁹⁵ The drawback to this is that the stereochemistry needs to be installed before the reaction takes place. Another is that the product of the RCM reaction is the dihydropyran and so a further reduction step is required in order to generate the tetrahydropyran moiety.⁹⁶

There are two classes of RCM reactions that can be used in the synthesis of these heterocycles. Class I consists of the ring closure of an ether that possesses an allylic or homoallylic functionality. This gives rise to the 3,4-dihydropyran, which can then be reduced to construct the desired tetrahydropyran.

Class II RCM reactions involve the ring closure of a homoallylic acrylate to generate the unsaturated lactone. This can then be further functionalised to a substituted tetrahydropyran. Molybdenum and ruthenium catalysts are commonly used in these reactions. The most common are Grubbs' catalysts, either first or second generation.⁹⁶

It is known in the class I reaction that olefin isomerisation/migration is possible. This affects the product distribution and reduces the overall yield of the desired compound. The unwanted isomers are also typically very difficult to remove using standard purification methods. The isomerisation is seen due to decomposition of the ruthenium metathesis catalyst to a ruthenium hydride species.

Grubbs explored compounds that could be added to the reaction that prevented the undesired isomerisation but that did not affect the metathesis reaction itself.⁹⁷ The most effective compound found to prevent this isomerisation was 1,4-benzoquinone. This works by being reduced, by the ruthenium hydride species, to the corresponding hydroquinone.

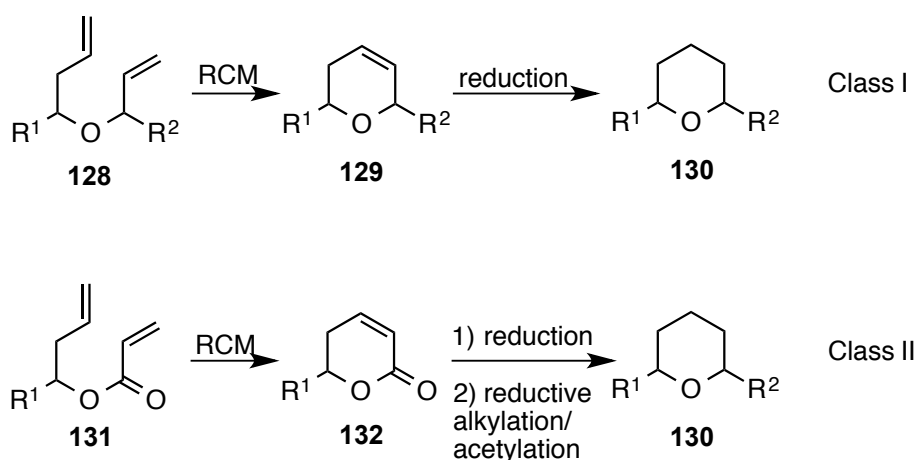

Scheme 1.23: Two classes of ring closing metathesis reactions. Adapted from reference 96.

Crimmins reported on the enantioselective total synthesis of the microbial metabolite known as SCH 351448 (**136**) in 2006.⁹⁸ One of the key steps in this synthesis relied on a class I RCM reaction. In the presence of Grubbs II catalyst and dioxenone (**134**), the acyclic polyene monomer precursor **133** undergoes a double RCM/cross metathesis tandem reaction and this proceeds with an 88% yield.

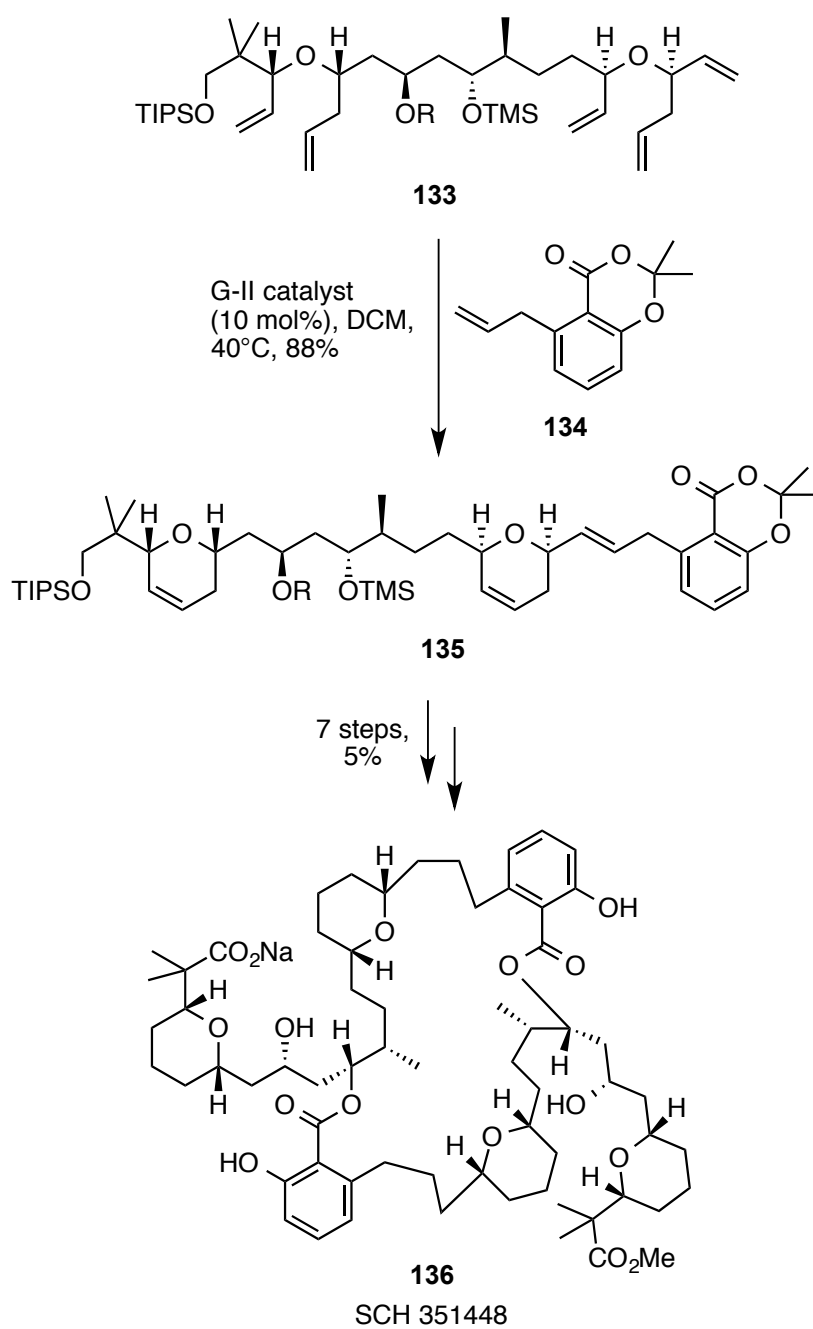

Scheme 1.24: Enantioselective synthesis of SCH 351448 using a double RCM/cross metathesis tandem reaction. Adapted from reference 98.

1.2.1.6. Tetrahydropyran Synthesis – Other

It is possible to synthesise tetrahydropyrans through the use of nucleophilic epoxide opening using an intramolecular hydroxyl group. The regioselectivity of this reaction is highly dependent on the stereochemistry of the epoxide and whether adjacent substituents possess a π -system or not, and so whether the *exo* or *endo* product is favoured. The epoxide needed for these reactions can be generated in several different ways, one being the Sharpless asymmetric epoxidation reaction.

In the case of δ -hydroxy-*trans*-epoxides, tetrahydropyran formation is favoured over the formation of the seven-membered oxepane regardless of the nature of the substituents. If the corresponding *cis*-epoxide is reacted and an adjacent substituent possesses a π -system then preferential oxepane generation is seen. With no π -system the major product is the tetrahydropyran. A similar situation is seen with the γ -hydroxy epoxides. The *cis*-epoxide favours the formation of the five-membered tetrahydrofuran regardless of the nature of the substituents. The *trans*-epoxide sees tetrahydropyran formation with an adjacent π -system present (see Scheme 1.26) but if it is not then tetrahydrofuran formation is seen.⁹⁶

The reasoning for this is that the adjacent π -orbital allows for stabilisation of the δ^+ charge and so favours the *endo* pathway over the *exo* route. If this stabilisation isn't present then the *endo* pathway is not the favoured route.⁹⁹

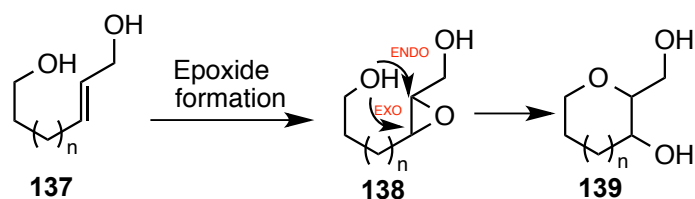

Scheme 1.25: Nucleophilic epoxide opening to form the saturated heterocycle. Adapted from reference 99.

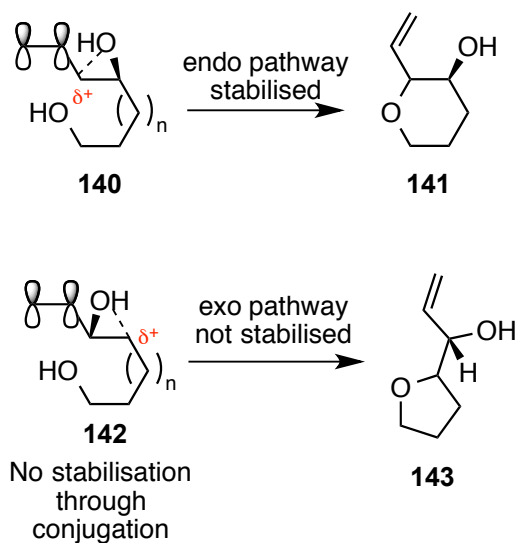

Scheme 1.26: Stabilisation of the *endo* pathway with an adjacent π -system. Adapted from reference 99.

In 2000, Bhatia and co-workers developed the nucleophilic epoxide opening to construct a tetrahydropyran ring that showed promise as a precursor to bryostatin 1 (**1**). The reaction was a 6-*exo-tet* ring-closure.¹⁰⁰

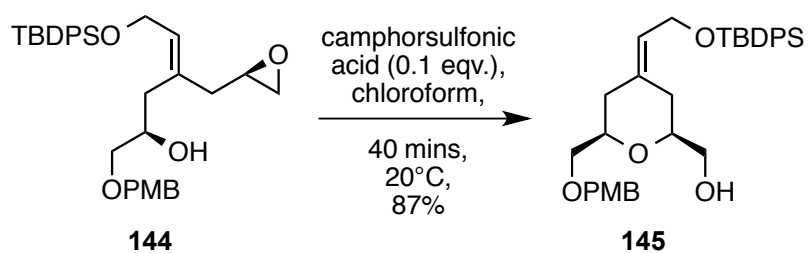

Scheme 1.27: Epoxide opening utilised in the synthesis of a bryostatin 1 (**1**) precursor. Adapted from reference 100.

1.3. Previous Work and Aims

1.3.1. Previous Work by the Group

Furan is a five-membered, aromatic heterocycle; however, furan will undergo transformations that lead to its dearomatisation relatively easily. The reasoning behind this is that although furan exhibits some level of aromatic stabilisation (with a resonance energy of $\sim 70 \text{ kJmol}^{-1}$), it is significantly less than is seen in benzene (151 kJmol^{-1}) and is also less than is seen in both pyrrole and thiophene – other five-membered, aromatic heterocycles.¹⁰¹ This means that furan is synthetically very useful as it can undergo a variety of transformations. Examples include a Diels-Alder reaction,¹⁰² Piancatelli reaction¹⁰³ or the Achmatowicz oxidation.¹⁰⁴ The electron-rich nature of the furanyl group (due to the lone pair of electrons present on the oxygen atom) means that it is able to stabilise cations that are adjacent to the group. Under acidic conditions the group has used this stabilising effect to facilitate the epimerisation of an adjacent ether chiral centre.

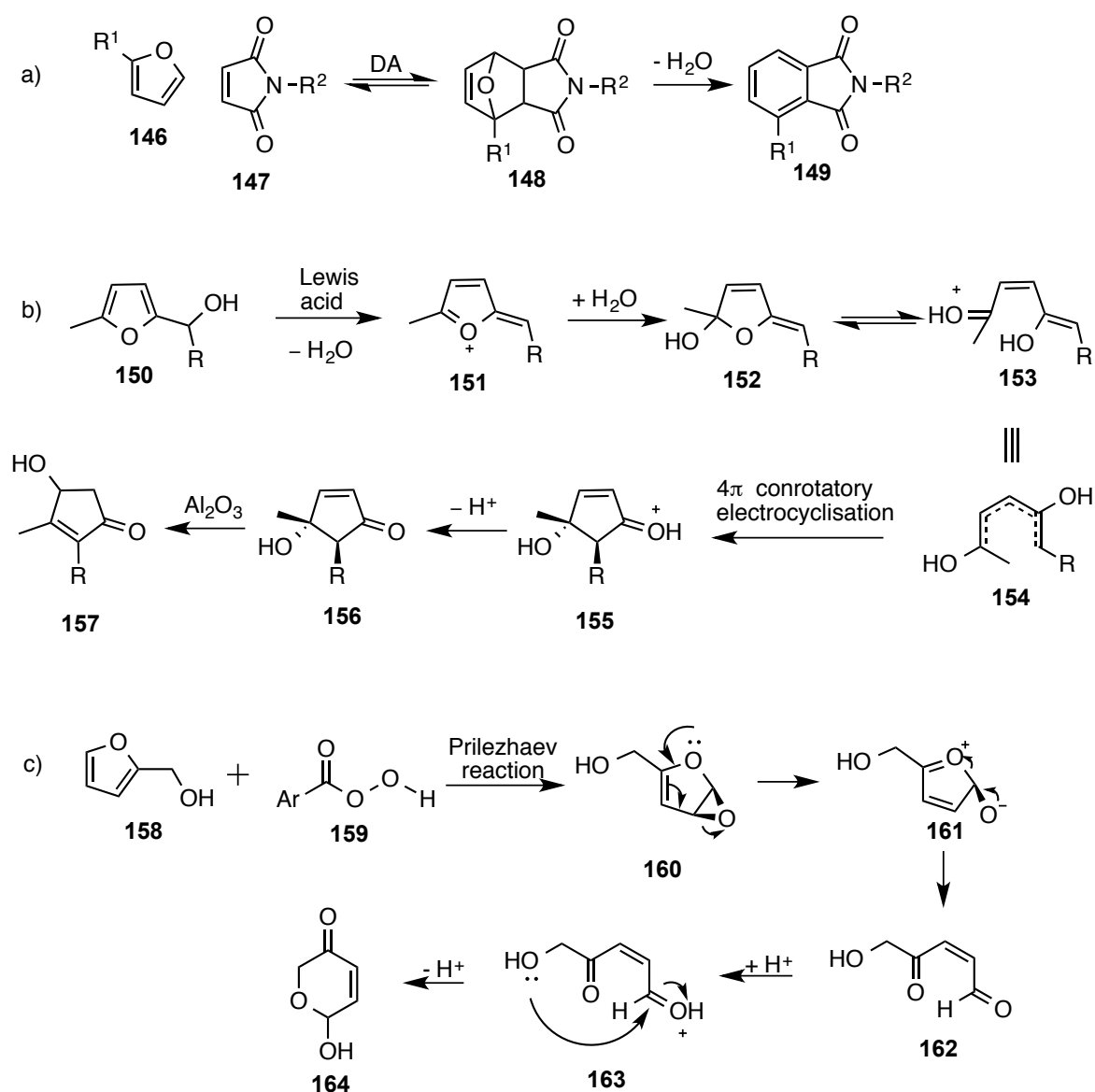

Scheme 1.28: Examples of furanyl compounds undergoing: a) a Diels-Alder reaction; b) Piancatelli reaction; c) an Achmatowicz oxidation

The use of the 2-furanyl group to facilitate the acid catalysed cyclisation and subsequent epimerisation was a technique that was applied in a number of syntheses by the group. The electron-rich furanyl group that can stabilise the cation on the adjacent chiral centre facilitates this epimerisation.

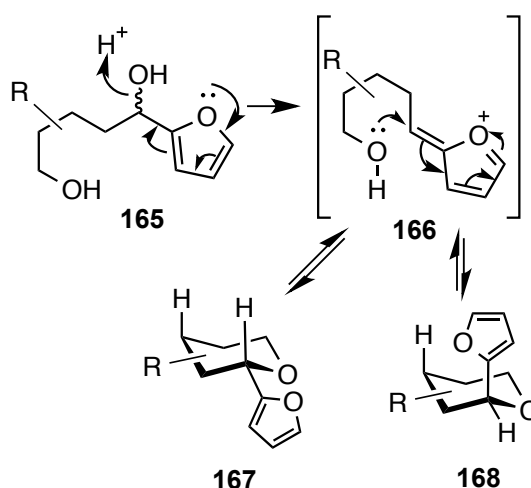

Scheme 1.29: Cyclisation method employed by the group.

Under acidic conditions the hydroxyl group adjacent to the furanyl group can be lost due to the stabilisation offered by the electron-rich furanyl group. The remaining hydroxyl group is then able to cyclise around to form the tetrahydropyran ring. In order to adopt the lowest energy conformation the tetrahydropyran ring will be found as a chair conformation. Assuming that the R group is locked in the equatorial position, preventing ring flipping, then the furanyl group can be located in either the equatorial position or the axial position. However, under these conditions the cyclisation step is reversible and it is possible, over time, for epimerisation to occur at this chiral centre allowing the more stable product (the equatorially substituted product) to form in a greater ratio over time.

One of the ways this methodology has been utilised by the group is in the synthesis of 2,6-disubstituted tetrahydropyrans.¹⁰⁵

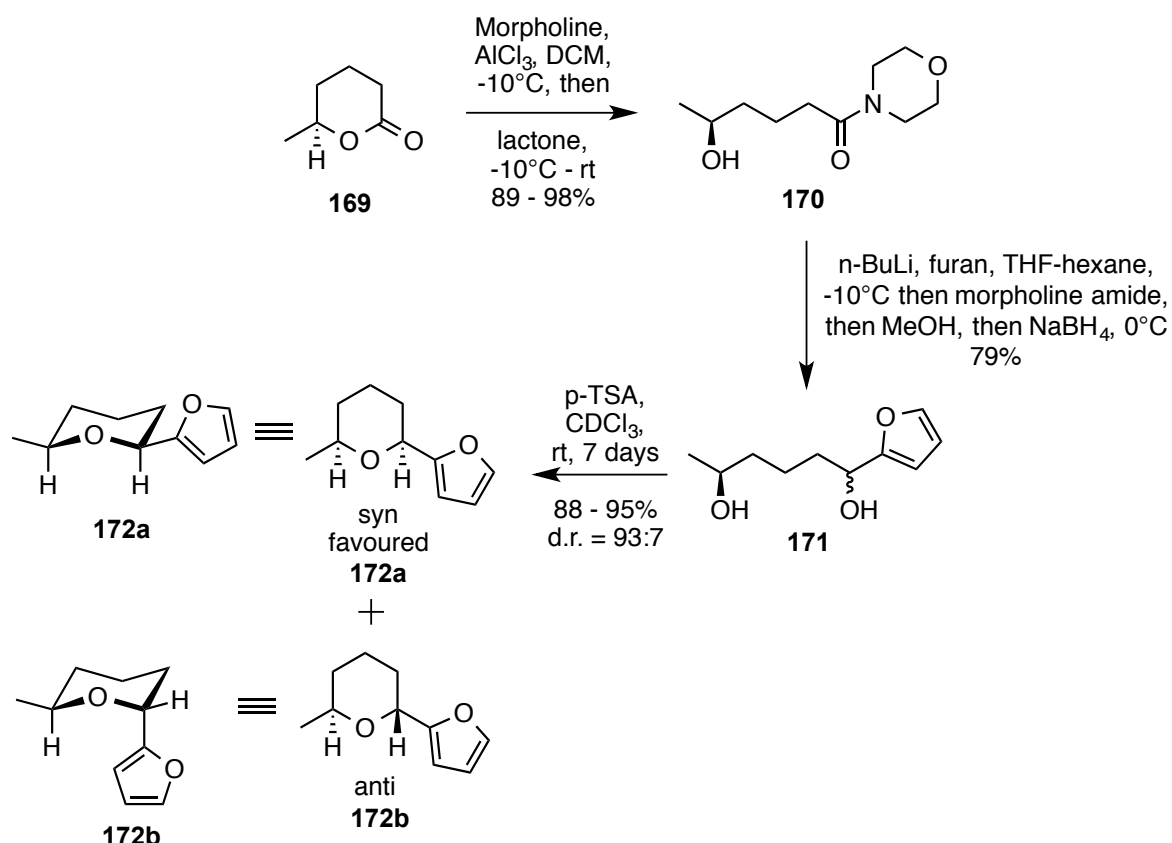

Scheme 1.30: Previously completed synthesis of 2,6-disubstituted tetrahydropyrans by the group. Adapted from reference 105.

The major stereoisomer (**172a**) seen from this previous synthesis was the *syn*-disubstituted tetrahydropyran. This possessed both substituents in the equatorial position and was the thermodynamically preferred product. In order to demonstrate the effectiveness of this method and how it could be useful in other syntheses the major diastereoisomer (**172a**) was taken on to synthesise the civet cat compound (+)-2-((2*S*, 6*S*)-6-methyltetrahydro-2*H*-pyran-2-yl)acetic acid (**176**). In this synthesis the furanyl group was transformed via RuCl_3 catalysed oxidative cleavage.

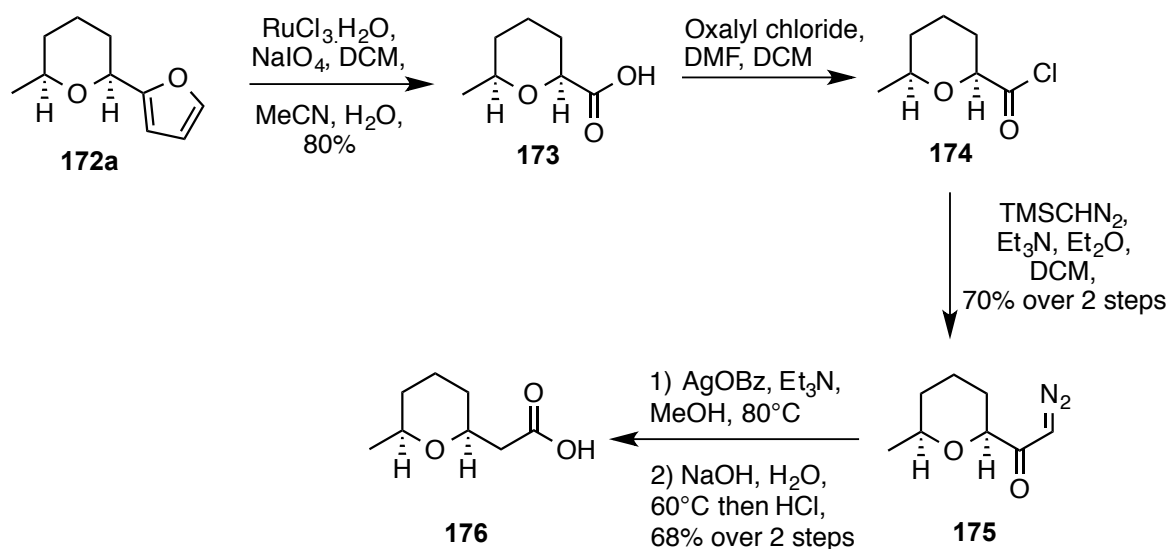

Scheme 1.31: Synthesis of the civet cat compound. Adapted from reference 105.

This methodology has also been used in the synthesis of nitrogen heterocycles in the form of 2,6-disubstituted piperidines. The nitrogen atom in this heterocycle was protected using a tosyl group. Literature suggested that when an electron-withdrawing group is located on the nitrogen atom, pseudoallylic strain dominated and caused the formation of the diaxial product.¹⁰⁶ This effect was indeed seen during the course of these experiments, probably due to the nitrogen atom's lone pair of electrons delocalising into the electron-withdrawing tosyl group. This resulted in a more planar arrangement with the two substituents in the 2 and 6 positions being located axially, minimising steric hindrance with the bulky tosyl group.¹⁰⁷

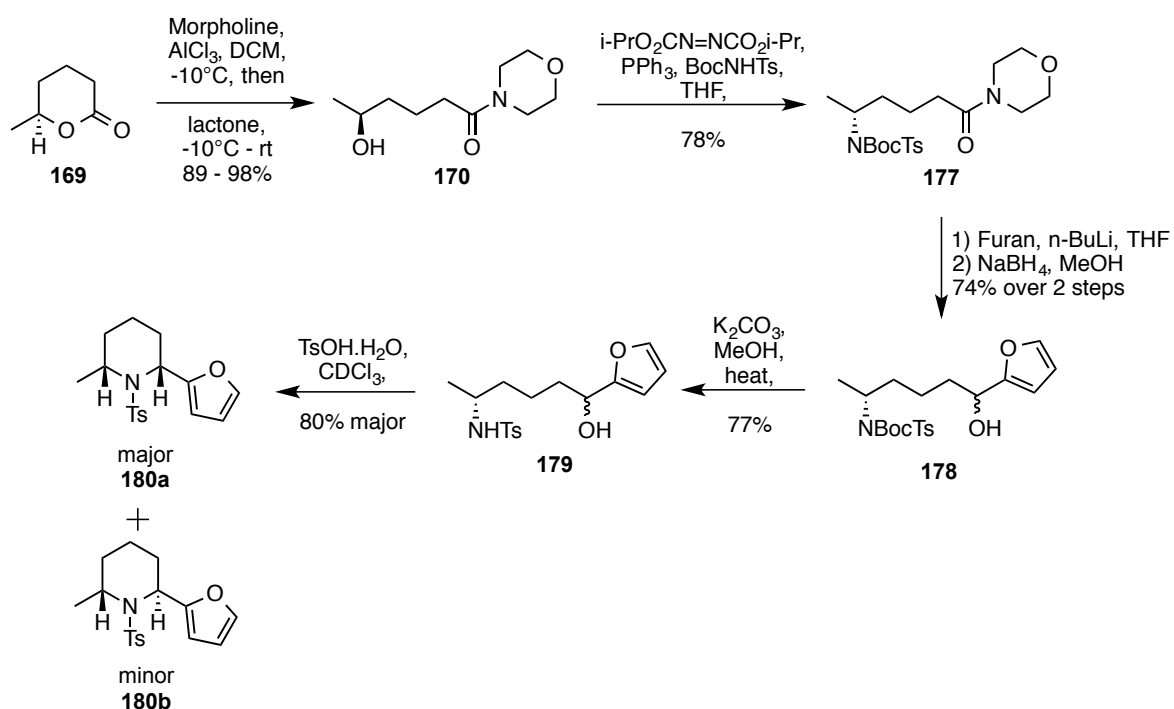

Scheme 1.32: Previously completed synthesis of 2,6-disubstituted piperidines by the group.

Adapted from reference 107.

The mechanism for the cyclisation and epimerisation in the piperidine synthesis is very similar to that seen for the 2,6-disubstituted tetrahydropyrans. Again the cyclisation step, under these acidic conditions, is reversible and this allows, over time, the furanyl group to facilitate the equilibration of the adjacent tosylamide chiral centre.

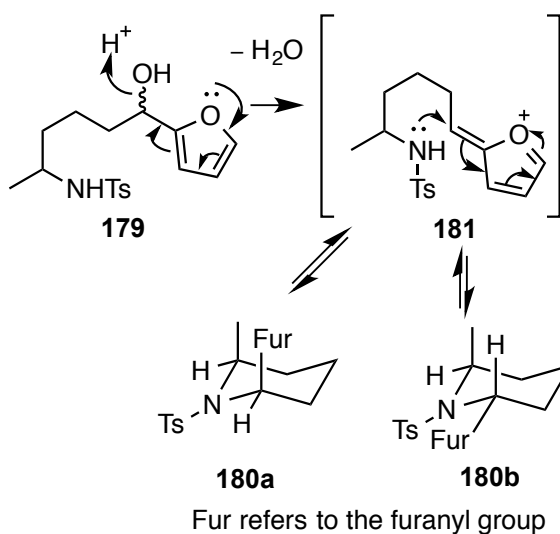

Scheme 1.33: Mechanism for the cyclisation and epimerisation of 2,6-disubstituted piperidines.

With both the tetrahydropyran synthesis and the piperidine synthesis, the stereoselectivity is achieved through the epimerisation of the furanyl chiral centre and both are under thermodynamic control as the more stable product is the one that forms preferentially over time. This is achieved due to the reversibility of the cyclisation step through a reversible elimination-addition mechanism.

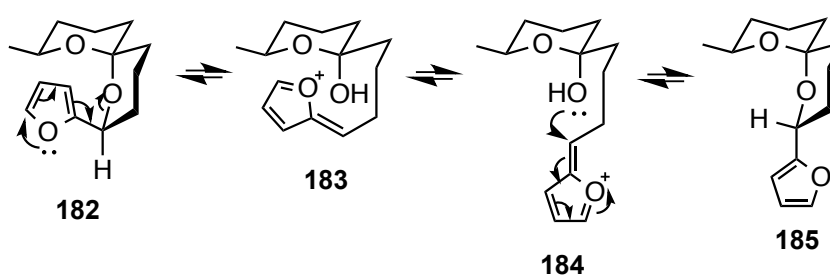

Scheme 1.34: Elimination-addition mechanism in the synthesis of spiroketals by the group.

This elimination-addition mechanism is something that was seen in the 2006 and 2007 reported synthesis of spiroketals by the group. Again this was completed using the epimerisable nature of the furanyl chiral centre.¹⁰⁸ The stereoelectronic

properties of spiroketals leads to their strong conformation preferences and this has given rise to their use as a scaffold in diastereoselective synthesis. The thermodynamically more stable isomer possesses substituents in the equatorial positions and a double anomeric effect is also seen in the compound. From this work diastereomeric ratios exceeding 98:2 were seen, favouring the compound that possessed a double anomeric effect and had all substituents located in equatorial positions (**185**).

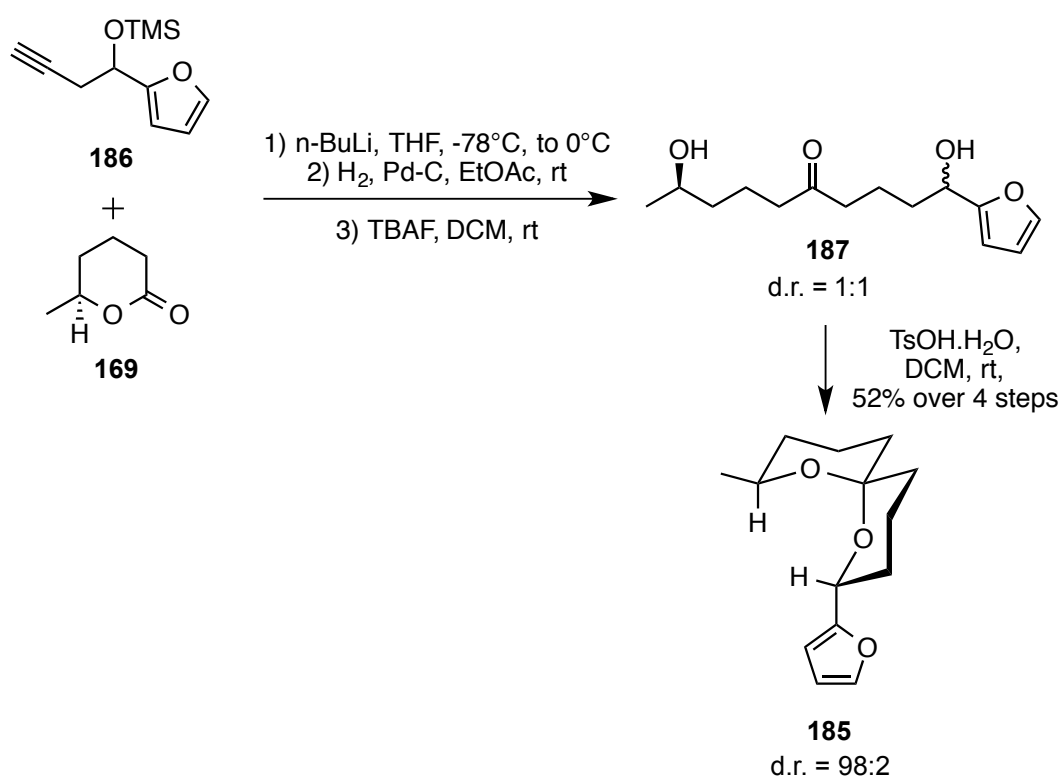

Scheme 1.35: Previous synthesis of spiroketals completed by the group. Adapted from reference 108.

Again to demonstrate the effectiveness of this method and its ability to be useful in the synthesis of natural products and biologically active compounds, spiroketal **185** was taken through a number of further steps to synthesise a number of *Bactrocera latifrons* pheromones.

1.3.2. Aims

- Development of the stereoselective synthesis of tetrahydropyrans through the use of an epimerisable furanyl chiral centre. This could be done in a number of ways:
 - ❖ Movement of the non-furanyl substituent.
 - ❖ Increase the number of substituents.
- Development of a synthetic route to an organometallic coupling compound that could provide an alternative route to tetrahydropyrans, piperidines, 6,6-spiroketals and 6,6-azaspiroketals.
- Development of a functional continuous flow system in order to complete a number of reactions, where both the reaction step and the subsequent aqueous work-up is completed in flow. The resulting organic solution obtained would ideally comprise of only solvent and the desired product. This is something that is currently receiving much attention and is a very topical area of research.

2. Results and Discussion

2.1. Working Towards the Synthesis of Azaspiroketal

The first project that was undertaken looked at developing the spiroketal synthesis that had previously been completed within the group.¹⁰⁸ The idea being to develop this methodology further and to construct a 6,6-azaspiroketal.

In previous syntheses the stereocontrol that was achieved when constructing the spiroketal was very high and possessed both substituents in the equatorial position, whilst also exhibiting a double anomeric effect as shown in Scheme 1.35 (Introduction). This was the expected result due to substituents generally favouring the equatorial position as the lowest energy conformation and also with the favoured lowest energy conformation of the 6,6-spiroketal possessing a double anomeric effect.¹⁰⁹

As demonstrated in previous work this was reliant on the epimerisation of the furanyl ether chiral centre over time to adopt the most favourable conformation via an elimination-addition mechanism as shown in Scheme 1.34 (Introduction). Despite the preference for the equatorial position when a ring has adopted a chair conformation, during the stereoselective synthesis of 2,6-disubstituted piperidines it was seen that substituents had a preference for the axial positions due to a steric clash with the bulky tosyl group that was bonded to the nitrogen atom in the heterocycle.¹⁰⁷

Combining these previous works suggested that the synthesis of this compound could provide some interesting stereochemical results. Would the final product possess the double anomeric effect with substituents in the equatorial position (**188b**)? Would the furanyl group be in the equatorial location and the alkyl group on the piperidine ring be located in the axial position (**188c**)?

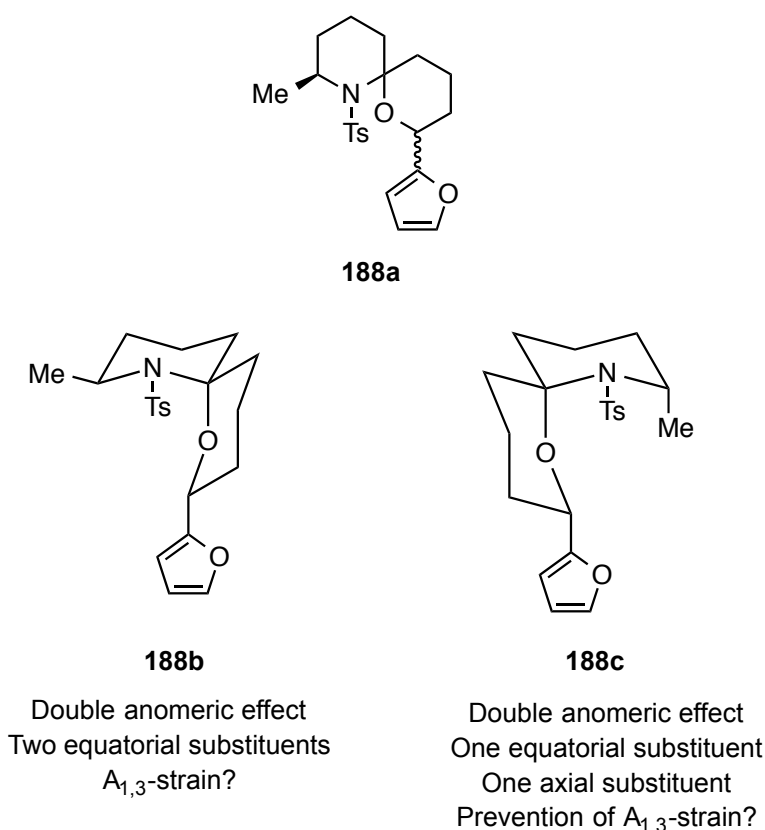

Figure 2.1: Theorised potential outcomes of the 6,6-aza-spiroketal formation.

It wasn't certain that the anomeric effect involving the nitrogen's atom lone pair would be seen. This is because of the delocalisation of the nitrogen's lone pair into the tosyl protecting group, meaning that it wouldn't be available for use in the anomeric effect. Research into the literature showed that a tosyl-protected piperidine ring with a methoxy substituent in the 2-position had been synthesised

by Shono in 1984¹¹⁰ and also by Somfai in 1992.¹¹¹ In both cases the stereochemistry of this compound is not discussed and it is difficult to determine the stereochemistry based on the NMR data provided.

A literature search for similar 6,6-azaspiroketal yielded a paper by Sinibaldi and Canet from 2005.¹¹² They synthesised a boc-protected 6,6-azaspiroketal with hydroxymethyl and ether substituents on the carbon adjacent to the oxygen atom and nitrogen atom respectively. Based on theoretical calculations the major diastereoisomer was reported as having a double anomeric effect, two equatorial substituents and the boc group in a pseudo-axial position. Further NMR experiments were conducted and nOe results obtained confirm the conformation of the spiro ring system.

This could mean that, unlike in the piperidine synthesis performed by the O'Brien group, that a diequatorial product with a double anomeric effect would be seen in the aza-spiroketal product **188**. However the difference between the boc and tosyl protecting groups could show that the stereochemical outcome could be influenced by the protecting group, something that could be exploited in stereoselective syntheses.

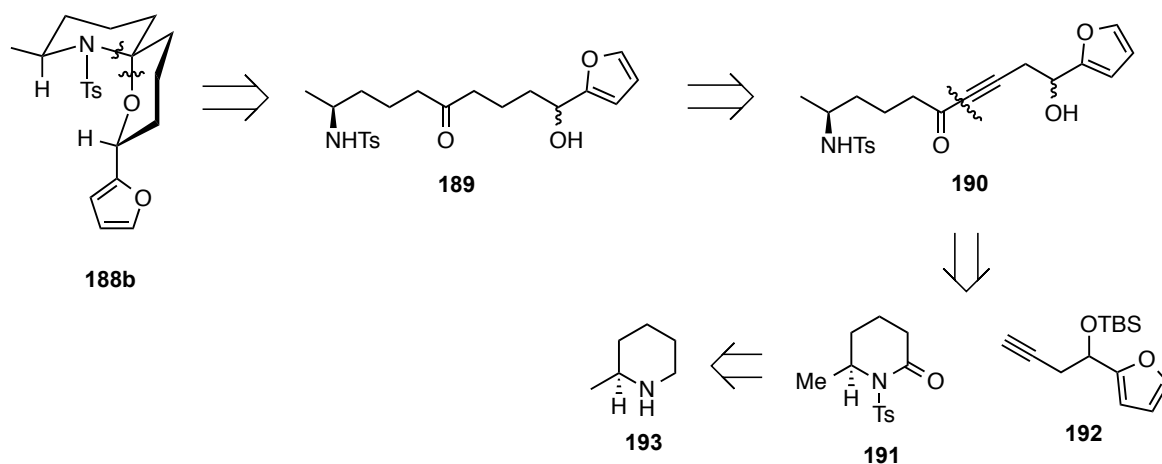

Scheme 2.1: Retrosynthetic analysis to the 6,6-azaspiroketal

The aza-spiroketal **188b** could be synthesised from the commercially available, racemic piperidine (**193**). This was tosylated using *p*-toluenesulfonyl chloride, along with triethylamine and 4-aminodimethylpyridine (DMAP). This proved an effective reaction that yielded a crystalline product. The tosylated piperidine (**194**) was then oxidised using sodium periodate and a ruthenium catalyst using methodology that has been described previously in the synthesis of this compound by Occhiato as shown in scheme 2.2.¹¹³

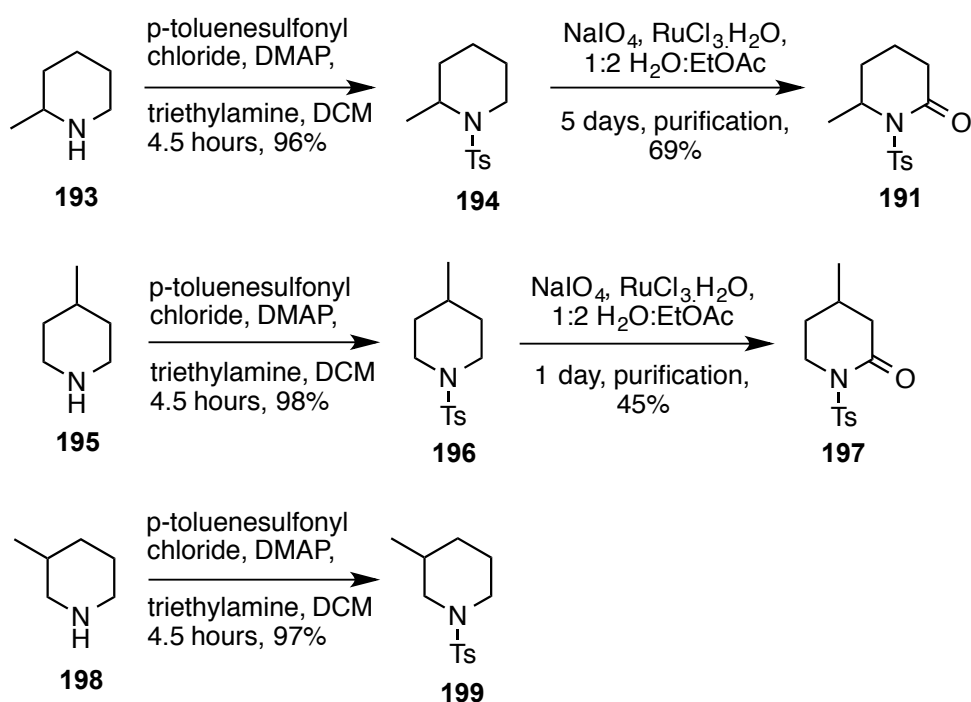

Scheme 2.2: Tosylation and oxidation of starting piperidines.

At this step of the reaction column chromatography using silica gel was required in order to purify the cyclic amide **191**. This is because the ruthenium chloride catalysed oxidation did not go to completion even after six days. This gave rise to reaction yields of 33 – 41%. NMR analysis showed that some of the material that was obtained off the column was the unreacted tosylated piperidine. In an effort to increase the reaction yield the material was subjected to the reaction conditions again and was then again purified by column chromatography. These efforts increased the overall yield to 69%.

Completing the reaction pathway using 2-methylpiperidine (**193**) would yield a 6,6-azaspiroketal where the methyl group is adjacent to the tosyl-protected nitrogen atom in the ring. In the group's previous synthesis of 2,6-disubstituted piperidines

the methyl group ended up in an axial position and it was thought that this could happen here; however, were the methyl group to be located in an alternative position then $A_{1,3}$ -strain may not be an issue. This could mean that the methyl group would be located in the equatorial position. In an attempt to explore this possibility these two steps were completed starting from the commercially available 4-methylpiperidine (**195**) and the tosylation step was completed with the commercially available 3-methylpiperidine (**198**). These two compounds were not taken further along the synthetic pathway due to issues that were identified with the progression of tosylated lactam **191**.

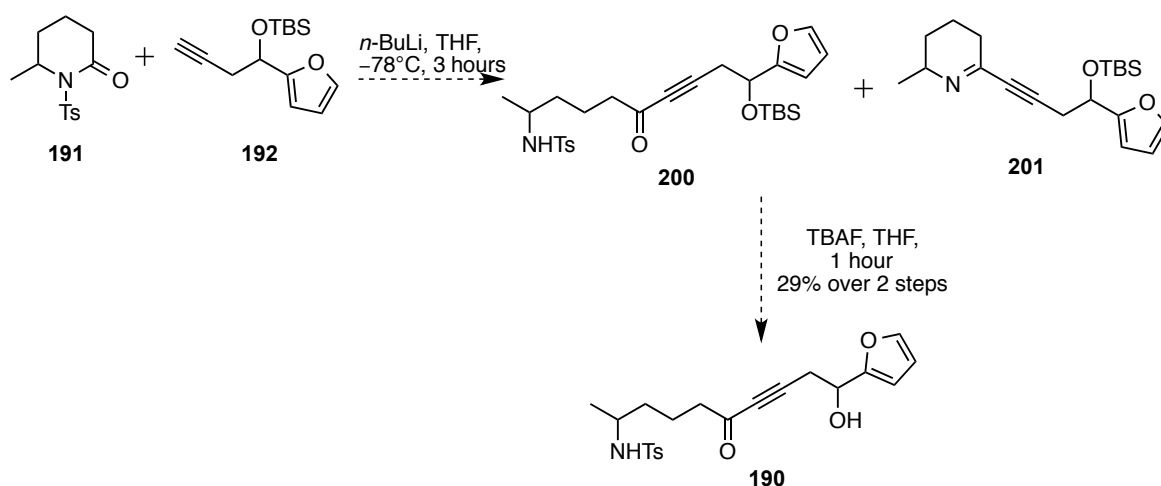

Scheme 2.3: Attempted coupling of alkyne **192** with piperidinone **191** and subsequent deprotection.

The next step in the reaction pathway was to couple the cyclised amide **191** to alkyne **192** in order to incorporate the furanyl chiral centre, as shown in Scheme 2.3. This was based on a similar step from the diastereoselective synthesis of spiroketals reported in 2007 by the group¹¹⁴ and some of alkyne **192** had previously been synthesised and stored in the freezer. $^1\text{H-NMR}$ analysis showed

that the compound hadn't degraded and was still pure, meaning it was suitable to use in this project. An alternative product was formed during the course of this coupling reaction and, based on spectroscopic data gathered, the putative structure of **201** was proposed.

Entry	Solvent	Base used	Temperature	Time	Result
1	THF	1.1 eqv. <i>n</i> -BuLi	-78°C	2 days	Unsuccessful
2	THF	1.5 eqv. <i>n</i> -BuLi	-78°C	2 days	Unsuccessful
3	THF over CaH ₂	1.5 eqv. <i>n</i> -BuLi	-78°C	2 hours	191 consumed – possibly 201 formed
4	THF over CaH ₂	1.5 eqv. <i>n</i> -BuLi	-78°C to -15°C	2 hours	191 consumed – potentially successful

Table 2.1: Summary of coupling conditions used with the tosylated piperidinone **191** and furanyl alkyne **192**.

A number of attempts were made to synthesise compound **200** and the conditions tested are summarised in Table 2.1. The material produced from entry 4 was analysed and this showed a more promising result than had been seen before. In the group's previous synthesis of spiroketals the furanyl alkyne (**186**) underwent a coupling reaction, hydrogenation, deprotection and cyclisation without any purification¹⁰⁷ and it is this that encouraged the tentative progression of this coupled material without further purification.

The next step of the reaction attempted the deprotection of the hydroxyl group. This was achieved using tetrabutylammonium fluoride (TBAF). This is the most commonly used method to deprotect silyl ethers and has been used in numerous syntheses.¹¹⁵ This is due to it being a fluoride source that is readily soluble in organic solvents and the conditions required for this deprotection means that many other functionalities are not affected. The crude yield over these two steps was 29%.

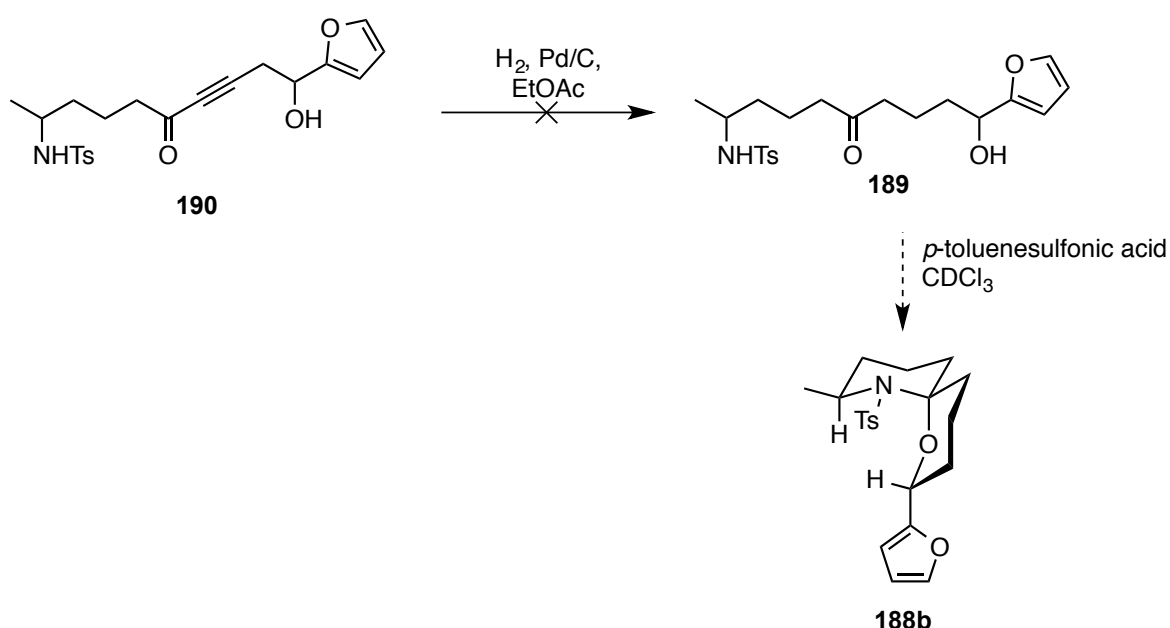

Scheme 2.4: Hydrogenation and cyclisation steps required to complete the 6,6-azaspiroketal synthesis.

Hydrogenation of the C-C triple bond to a C-C single bond was attempted on the crude material obtained after the deprotection. This was done using a Pd/C catalyst, allowing for complete reduction of the alkyne functionality to the saturated alkane. The alkene was not observed as it was also hydrogenated under these conditions.¹¹⁶

Upon completion of the reaction and subsequent work-up the crude material was immediately subjected to acidic conditions in d-chloroform in order to affect the spiro-fused product; however the NMR spectra were not consistent with the desired product. After one day no change was seen in terms of approaching an aza-spiroketal but the material started to degrade and data suggested that the azaspiroketal had not been successfully synthesised.

Concurrent work within the group on similar systems suggested that the hydrogenation reaction was highly dependent on timing. In these studies it was found that, following alkyne hydrogenation, the furanyl group itself was also being hydrogenated at a significant rate.

Due to the problems encountered with the hydrogenation step it was considered for use in flow chemistry (see section 2.6.). In flow chemistry it is far easier to control the contact time between the solution and the hydrogen gas. This means that the contact time can be far more finely tuned and hopefully will allow for the hydrogenation of the alkyne bond without affecting the furanyl group. This reaction has not yet been completed but is an avenue of investigation that will be explored in the future. At the same time as investigating this reaction, work began exploring the development of a 4-furanyl-4-hydroxyorganometallic coupling partner based on work done by Katritzky that would allow an alternate route for tetrahydropyran and piperidine synthesis. Focus shifted onto the development of this coupling partner due to its possible versatility and use in a number of potential future projects and so the aza-spiroketal synthesis has yet to be investigated further.

2.2. Development of a 4-furanyl-4-hydroxy-Organometallic Coupling Partner

Organometallic reagents are versatile and powerful tools in synthetic organic chemistry,¹¹⁷ which are commonly used in reactions with carbonyl compounds (including lactones).¹¹⁸ When adding to aldehydes and ketones the carbonyl group is transformed to a hydroxyl group. Esters are also commonly used with organometallic coupling partners (with this there is the possibility of double addition) as are imines.¹¹⁹ There are two issues seen when using imines in these reactions. The first is that imines (and carbonyl compounds) can enolise, or undergo a reduction in the presence of a Grignard reagent, rather than the desired nucleophilic addition.

Work on the competing reactions in a carbonyl system were examined by Mosher and Cowan in 1962.¹²⁰ The presence of an acidic proton on the α -carbon means that the basic Grignard reagent can remove it to generate the enolate anion (from carbonyls) or the aza-enolate anion (from imines). Hydrolysis of this anion regenerates the original starting ketone. The nucleophilic addition reaction is usually the more rapid reaction but this competing process can still be seen. If the Grignard reagent possesses a β -hydrogen then it is able to act as a reducing agent in a competing process to the desired nucleophilic addition. This reduces the carbonyl to the corresponding alcohol or the imine to the corresponding amine whilst the Grignard reagent forms an alkene (**205**).¹²⁰ This is known as the Meerwein-Ponndorf-Verley reduction,¹²¹ though typically it is achieved with an aluminium catalyst.¹²²

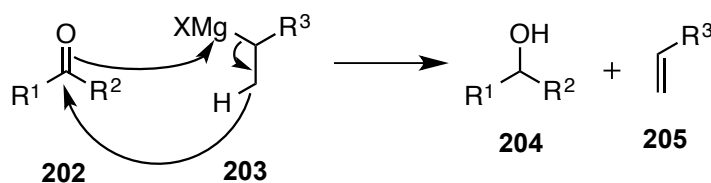

Scheme 2.5: Reduction reaction that can be seen competing with the nucleophilic addition of a Grignard reagent when a β -hydrogen is present on the Grignard reagent.

Another issue seen when using imines is the poor electrophilicity of the carbon in the C=N bond. Due to this the electrophilicity often needs to be increased for these reactions and this can be achieved through the alkylation, acylation, oxidation or sulfonylation of the nitrogen atom.¹²³ The activating group can then be cleaved after the reaction has taken place to garner the free amine. Another route to achieve this is to activate the imine through co-ordination with a Lewis acid.¹²⁴

The idea behind this project was to use the knowledge of these reactions involving organometallic reagents and use them to synthesise a diol or hydroxylamine through reactions with lactones, ketones, aldehydes and sulfonylated imines. These could then, under acidic conditions, cyclise to produce the corresponding heterocycle. To ensure stereoselectivity the organometallic compound that was envisioned would contain a furanyl chiral centre, adjacent to one of the hydroxyl groups that would participate in the cyclisation, and this could epimerise under the acidic conditions, hopefully giving high levels of stereoselectivity. The organometallic reagent would therefore be utilised, as the key component, in a number of syntheses (see Scheme 2.6).

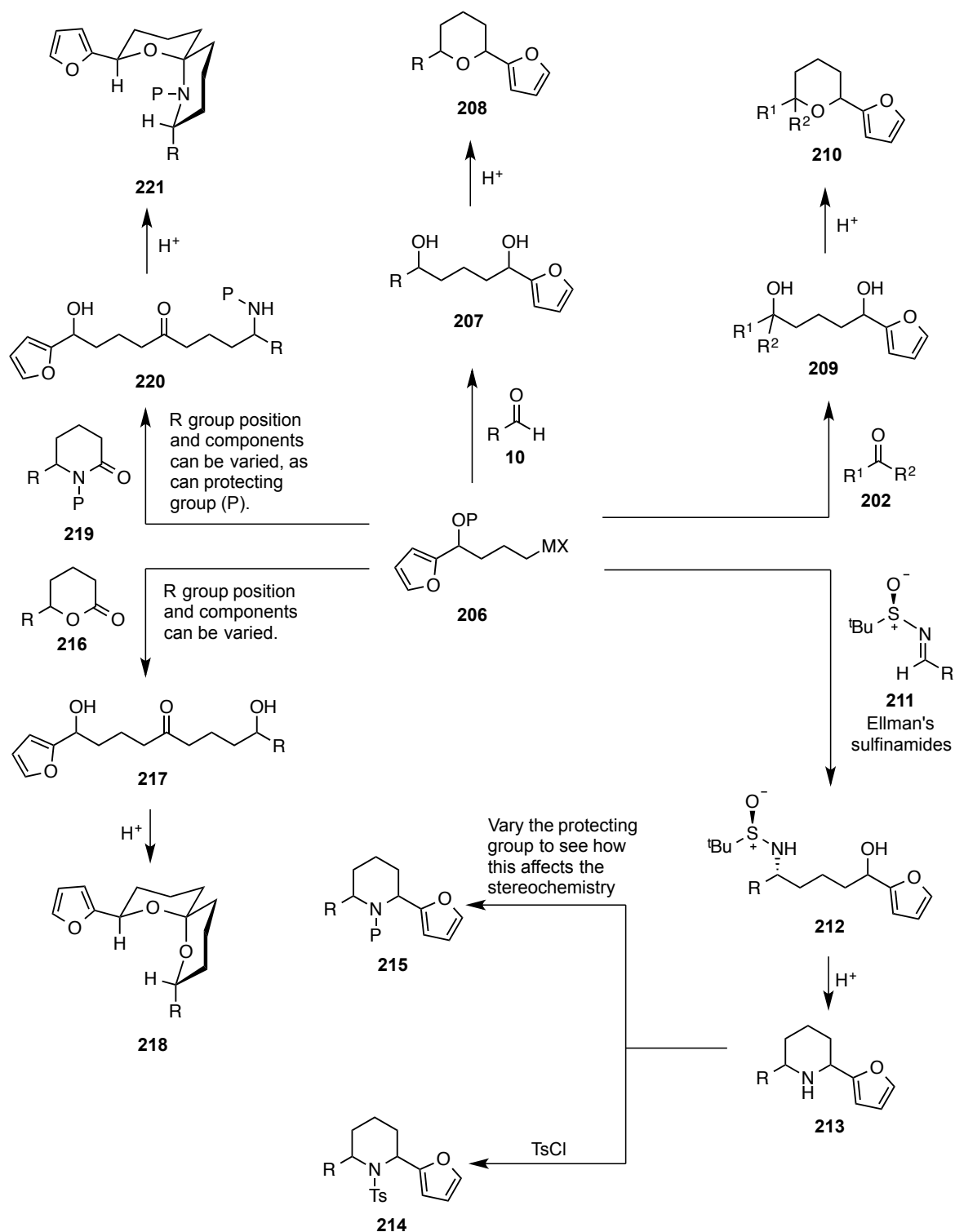

Scheme 2.6: Potential uses for the organometallic coupling partner. 'P' refers to a protecting group.

The synthetic route designed for the synthesis of this Grignard reagent began with commercially available 5-methylfurfural (**222**). The plan was to convert the aldehyde to a ketone using a masked acyl anion approach – an umpolung approach. The conversion of aldehydes to ketones via this method is something that has been explored by Katritzky and co-workers. They showed that benzotriazole is useful as an effective activating and leaving group.¹²⁵ An umpolung route utilising cyanohydrins could also be considered in the future.¹²⁶

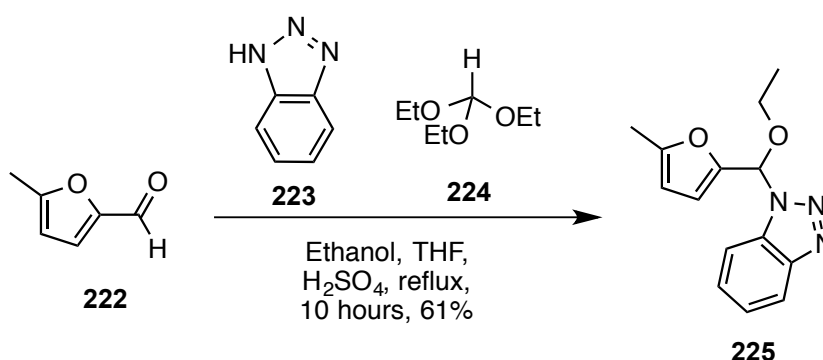

Scheme 2.7: Reaction of 5-methylfurfural (**222**) to yield the benzotriazole adduct **225**.

Katritzky had used furfural as one of the aldehydes and he reported that the compound was easily converted to the corresponding benzotriazole adduct in three hours stirring at room temperature. Katritzky also reported on a number of substituted benzaldehydes and how, unlike the five-membered heterocyclic compounds, these were stirred for three hours and then refluxed for ten hours.

Entry	Aldehyde	Time	Temperature	Result
Reported	Furfural	3 hours	rtp	Successful
1	5-methylfurfural	5 hours	rtp	No reaction
2	5-methylfurfural	15 hours	Reflux	3:1 mixture of product and impurity 226

Table 2.2: Reaction conditions used to obtain benzotriazole adduct **225**.

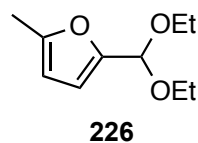
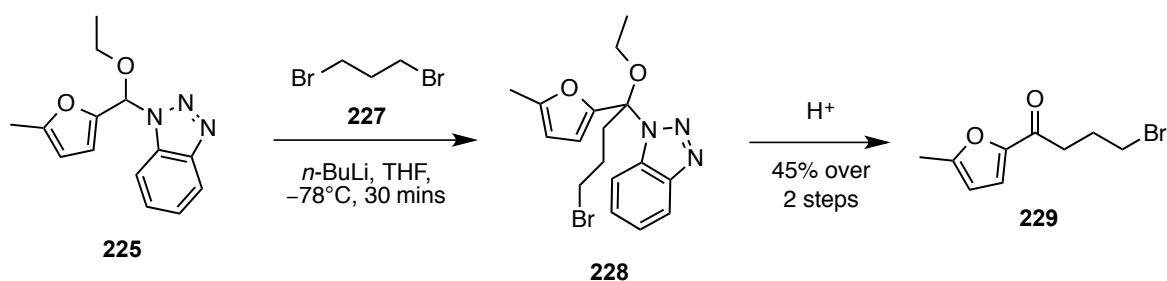

Figure 2.2: Theorised acetal impurity formed during the formation of benzotriazole adduct **269**.

Benzotriazole adduct **225** proved to be unstable with regards to column chromatography, heat and deuterated chloroform. Due to the inability to purify this material *via* column chromatography, an alternative approach was sought. Dissolving the crude product in petroleum ether yielded a solution that contained compound **225** along with a crystalline material. Upon further investigation this was found to be benzotriazole (**223**). The trace quantity of triethyl orthoformate (**224**) that was also present in the solution was taken through to the next stage of the synthetic pathway.

The next stage of using this umpolung approach was to use a strong base in order to deprotonate the benzotriazole adduct **225** and react this with a relevant electrophile before hydrolysis of the hemiaminal to reveal the carbonyl group.



Scheme 2.8: Formation of bromoketone **229**.

Deprotonation was achieved through the use of *n*-butyl lithium solution (2.5 M in hexanes) and the electrophile used was 1,3-dibromopropane (**227**). This incorporated the correct number of carbon atoms to synthesise a six membered heterocycle after the Grignard coupling reaction. It also incorporated a bromine atom that could be used to form the Grignard reagent.

Hydrolysis of the hemiaminal to reveal the carbonyl group was achieved under acidic conditions. Initially hydrochloric acid was used to achieve this transformation. Unfortunately after column chromatography no fractions corresponded to ketone **229**. The crude ¹H-NMR spectrum of this material showed the presence of benzotriazole, triethyl orthoformate, ethanol and a compound that contained an aldehyde peak, which may have been 5-methylfurfural.

Due to the lack of success upon using hydrochloric acid an alternative was tested. Polymer-supported sulfonic acid offered both a slightly weaker acid and also a greatly simplified work-up procedure. Intermediate **228** was dissolved in a 4:1 mixture of THF and water, to which the polymer-supported acid was added. After two hours the reaction had gone to completion. The crude ¹H-NMR showed the desired compound with benzotriazole present and the trace of triethyl orthoformate that had been brought through. After purification, ketone **229** was obtained in 73% yield.

Once the ketone had been successfully synthesised the next step was reduction to the alcohol, followed by protection of the hydroxyl group. A variety of reducing agents are available for this transformation, along with a multitude of protecting

groups. Initially the reduction was trialed with sodium borohydride.¹²⁷ This reaction was successful but gave low yields.

Despite this enough material was amassed to test protecting the alcohol. The protection method chosen was to form the *tert*-butyldimethylsilyl ether. This was selected because: it is stable to a variety of conditions, including those of Grignard formation and because it can easily be removed.¹²⁸

Initially the conditions used for this reaction matched those of Corey in 1972, using imidazole to increase the rate of reaction. The imidazole reacts with the silyl reagent to produce a more reactive compound, (in this case *tert*-butyldimethylsilyl imidazole), which then reacts with the alcohol.¹²⁹ However, substoichiometric quantities of 4-dimethylaminopyridine (DMAP) were required for a successful reaction in seven hours, rather than two days without.

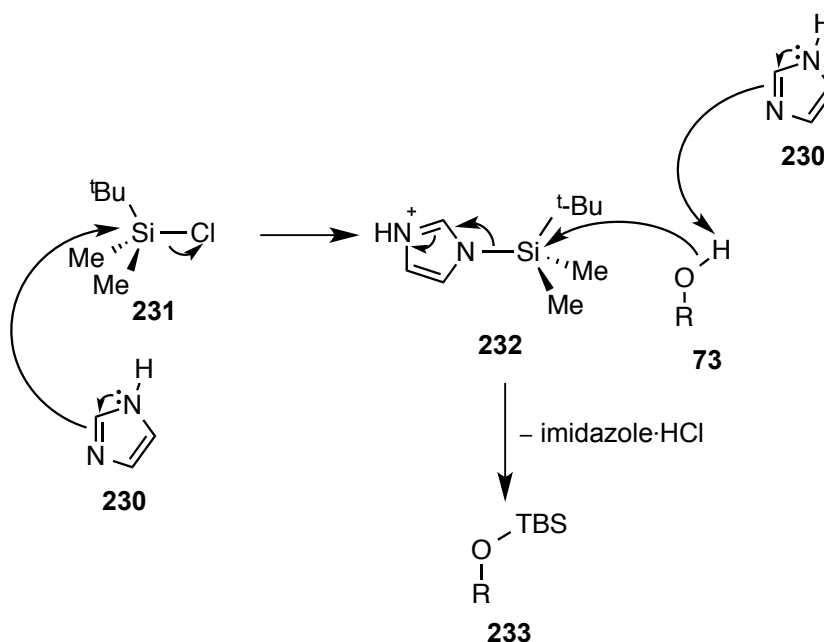

Scheme 2.9: Formation of *tert*-butyldimethylsilyl imidazole and the subsequent protection of an alcohol. Adapted from reference 129.

Both of these steps gave low yielding results. Evidence from spectroscopic data implied that a side reaction was occurring during the reduction step, where the alkoxide that formed, engaged in an intramolecular 5-exo-tet ring closure resulting in product **235**. Evidence suggested that this was a volatile compound and it could easily be removed. This compound was synthesised by Harwood and Robertson in 1987, through the cyclisation of 4-(2-furanyl)-1-butanol and derivatives in DDQ and dioxane (no spectroscopic data was provided).¹³⁰

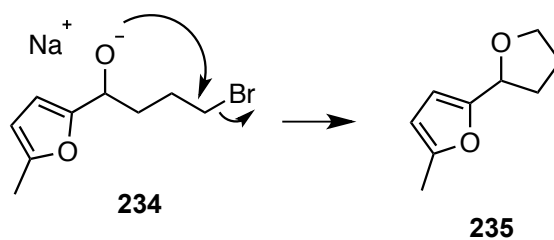

Scheme 2.10: Potential mechanism for the theorised impurity seen during the reduction of bromoketone **229**.

Due to the low yields seen alternative approaches were examined. DIBAL-H (**24**) and Red-Al (sodium bis(2-methoxyethoxy)aluminium hydride) were tested.

Entry	Reducing agent	Solvent	Temperature	Time	Result
1	NaBH ₄	MeOH	-15 °C	1 hour	20% yield
2	DIBAL-H	THF	-78 °C	7 hours	58% yield
3	Red-Al	THF	-78 °C	10 mins	Taken through crude

Table 2.3: Reduction reactions tested with bromoketone **229**.

These gave low to moderate yields and the material was protected in the manner described previously to look at the yields over two steps. One pot reactions were also tested and the results are summarised in Scheme 2.11.

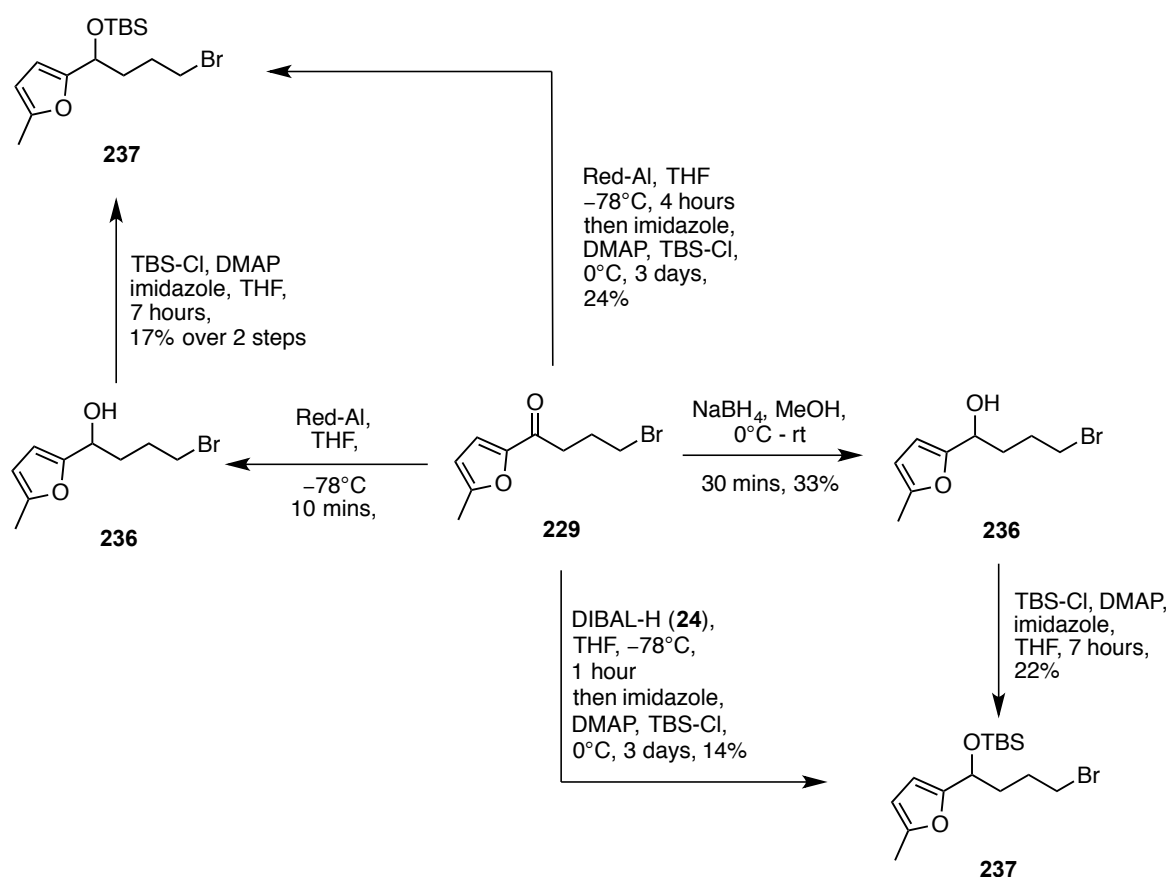

Scheme 2.11: Summary of reactions tested to obtain the TBS-protected alcohol **237**.

Due to consecutively low yields seen regardless of reducing agent, an alternative protecting group was reviewed. The incorporation of a methyl-protecting group, producing the corresponding methyl ether, was investigated. The reaction was completed using methanol and polymer-supported sulfonic acid. This reaction proved unsuccessful and one possibility was that methanol was being eliminated from the desired product, resulting in compound **239**.

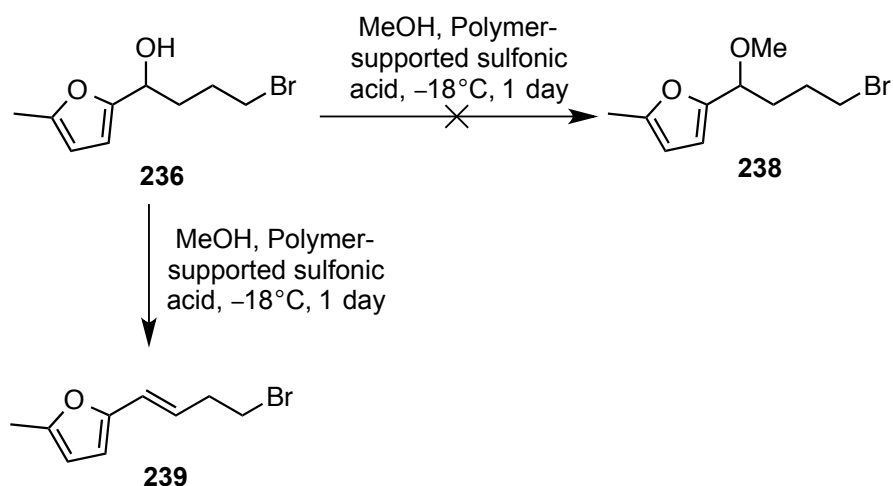

Scheme 2.12: Attempted conversion of a hydroxyl group to a methoxy group under acidic conditions.

At this point in time other protecting groups were not looked at, but rather the protected material **237** that had been successfully synthesised was used in an attempt to form a Grignard reagent and coupled with a commercially available aldehyde.

Grignard formation is a well-known and widely utilised tool and it has been proposed that it is a non-chain radical reaction. The theorised mechanism is initiated through a single electron transfer from the exposed magnesium surface to the organic halide. This yields a radical anion that is associated with the radical cation of the surface magnesium. The magnesium acts as a Lewis acid and it is able to co-ordinate and add stabilisation to the complex.¹³¹

Iodine is known to be a catalyst in the formation of Grignard reagents. One thought behind this is that the iodine cleans the surface of the magnesium. Another theory

is that the iodine forms magnesium (I) iodide *in situ* and this is the catalytic species of the reaction.¹³² Much investigation has occurred to determine the mechanism of this proposed catalysed reaction and the currently accepted mechanism is shown in Scheme 2.13.

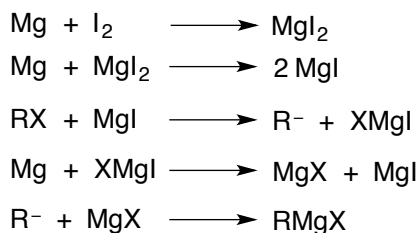

Scheme 2.13: Formation of Grignard reagent utilising an iodine catalyst.

Grignard formation was attempted with an iodine catalyst and after this, an attempt was made to couple the subsequent Grignard reagent with octyl aldehyde (**240**). After one day no reaction was seen and this may be due to the small scale that the reaction was attempted on as Grignard reactions are well-known for being low-yielding and difficult to complete.¹³²

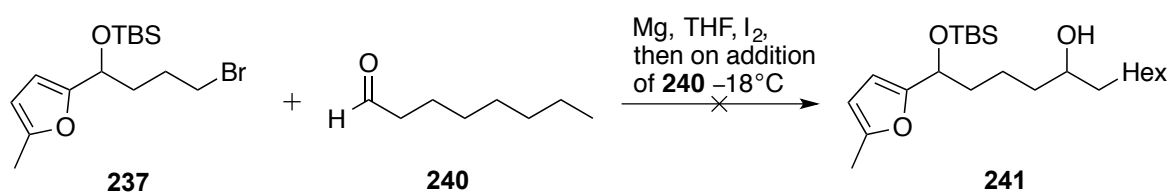

Scheme 2.14: Attempted Grignard coupling.

The overall yield of the reaction going from 5-methylfurfural (**222**) to the protected alcohol **237** gave an initial yield of 4%. With the modifications discussed this yield

was increased to 7% but this is still quite low and alternative routes to suitable Grignard reagents could be developed.

It was thought that one of the reasons for the low yield seen was the possibility of an intramolecular reaction to forge the tetrahydrofuran **235**. One of the methods by which that could be avoided was to not have the halide atom present at the start of the reaction pathway and instead make use of an Appel-type reaction to incorporate this functionality from the alcohol precursor.

The advantage to this new route was that all of the steps involved were similar to well-known reactions that produced high yields, theoretically allowing easy access to a large quantity of material to convert to the Grignard reagent. The halide also wouldn't be introduced to the molecule until the free alcohol was protected, meaning that cyclisation of the compound should not be seen.

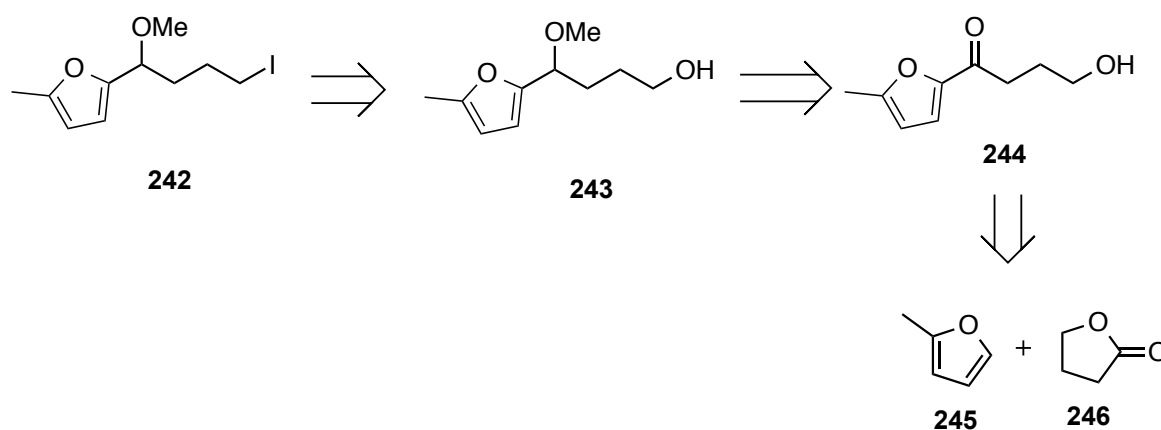

Scheme 2.15: Retrosynthesis of 4-furanyl-4-methoxybutyl iodide.

The first step in this pathway involved a reaction between 2-methylfuran (**245**) and γ -butyrolactone (**246**). The 2-methylfuran was purified prior to any reaction occurring.

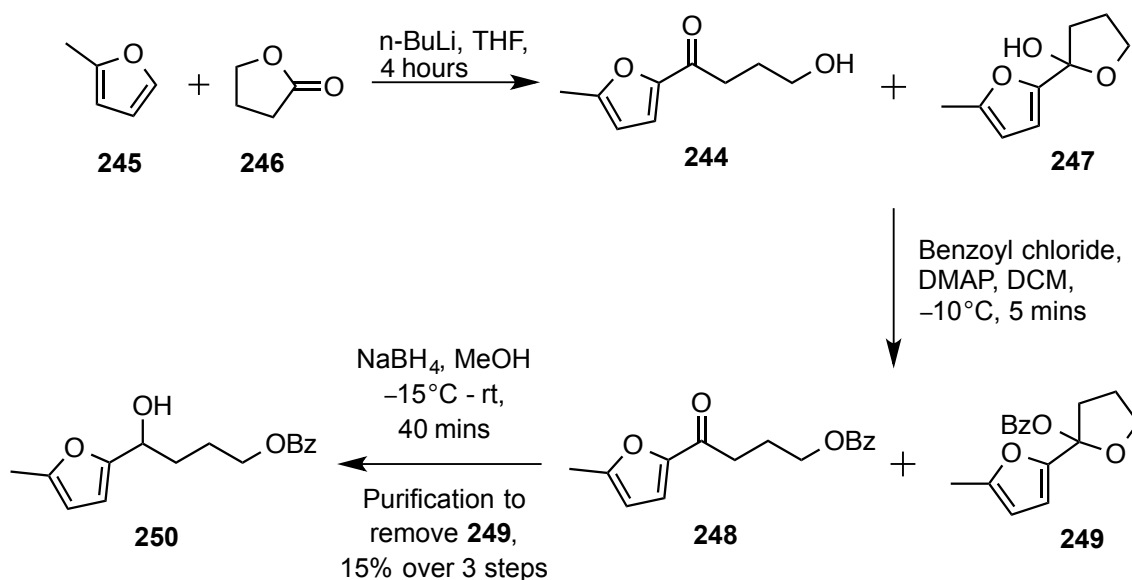

Scheme 2.16: Procedure followed to achieve **250**.

The idea behind the reaction was to lithiate the 2-methylfuran (**245**) at the 5-position then allowing it to react with γ -butyrolactone (**246**), opening the lactone ring and producing the furanyl ketone **244**. There was some literature basis for this reaction. In 2006 Guo reacted furan with γ -butyrolactone in 74% yield¹³³ and in 2007 the Nicolaou group reported this reaction in the synthesis of a ring system of maitotoxin in a 58% yield.¹³⁴ In both these cases an unsubstituted furanyl compound had been used; however Nicolaou had performed the same reaction with a substituted furan and an acyclic compound possessing a C=O bond. This gave a 91% yield and demonstrated that a substituent in the 2-position would not hinder the reaction. Further research into the literature demonstrated that there

were a large number of C-2 substituted furans that had been lithiated at the relatively acidic C-5 position using both *n*-butyl lithium solution or lithium diisopropyl amide.¹³⁵

Upon completion of the reaction, it was apparent that an impurity was present alongside the desired compound. Spectroscopic data was gathered on the impurity and this led to the belief that the compound was the cyclised form, 2-(5-methylfuran-2-yl)tetrahydrofuran-2-ol (**247**). Both compounds demonstrated good stability and it was decided to take the crude mixture through the next two steps and then purify, to allow for an easier separation.

With the furanyl ketone in hand attention turned to protecting the primary alcohol. This is because in the coming steps the ketone will be reduced to the secondary alcohol and protected in the form of a methyl ether. The protection of the primary alcohol needed to happen before this, due to selectivity issues that would be seen if this were not done.

Protection of the primary alcohol was achieved using benzoyl chloride and DMAP. Compounds **244** and **247** were both protected and taken through to the next step crude. This was because only the desired compound **248** would be reduced to the alcohol, greatly simplifying the separation of these two compounds.

The reduction was completed using sodium borohydride and went to completion within forty minutes. Purification by column chromatography removed the cyclised impurity (**249**), though this was not successfully isolated meaning that the identity

of this compound is not definite. The yield of pure desired material at the end of this reaction was 8% over three steps. However, approximately half of the potential yield was lost to the cyclic impurity.

As this step was at the start of the synthesis pathway, it meant that the initial reactions could be conducted on a larger scale, to accumulate more material due to the low yield. The three reactions were repeated on a four times larger scale and this gave a 15% yield over the three steps. A third batch of material was brought through also giving a 15% yield over three steps. This is likely due to becoming more familiar with the column conditions and the relevant work-ups.

One potential change that could be attempted in the future is completing the reduction reaction using DIBAL-H. In the previously attempted Grignard reagent synthesis DIBAL-H (**24**) gave a higher yield than use of sodium borohydride and it would be interesting to see whether that would be mirrored in this synthesis; however the potential difficulty of removing the DIBAL-H by-products may mean that this is not an effective route after all.

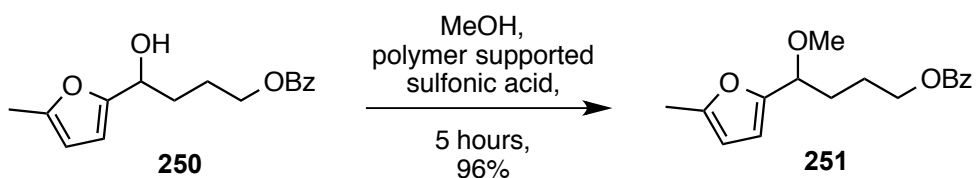

Scheme 2.17: Conversion of the hydroxyl group to the methyl ether.

As in the previous synthesis the secondary alcohol was then converted to the methyl ether. Initial thoughts were to use a protecting group such as a *tert*-

butyldimethylsilyl ether again but conversion to the methyl ether was completed in less than a day and did not require any substantial work-up or purification because polymer supported sulfonic acid was used and this polymer could just be filtered off at the end of the reaction. The use of these polymer-supported compounds in organic synthesis is something that is becoming increasingly popular and due to the ease of work-up it is easy to see why this is the case.¹³⁶

The reaction was completed in 5 hours and provided pure **251** after filtering the polymer-supported acid. All three batches of material were brought through this step.

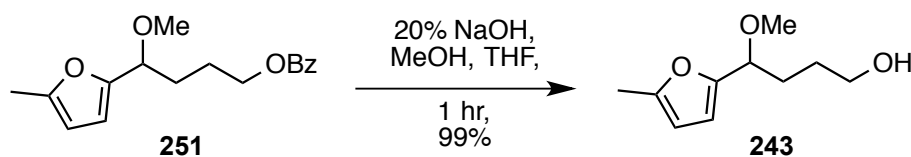

Scheme 2.18: Removal of benzoate ester through base hydrolysis.

The benzoate ester was cleaved using alkaline hydrolysis. Once all the material had undergone this process, the Appel-type reaction was investigated, in order to convert the primary alcohol in **243** to the iodide **242**.

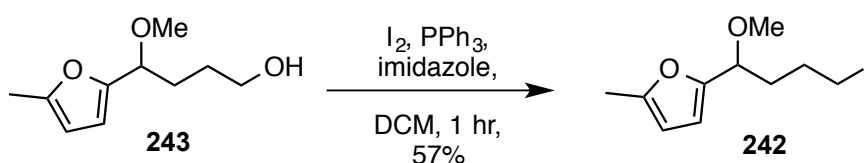

Scheme 2.19: Conversion of primary alcohol **243** to the corresponding iodide **242**.

The Appel-type reaction uses triphenylphosphine (**252**), typically with a tetrahalomethane (such as CCl₄); however the reaction can be performed using iodine rather than tetraiodomethane. Triphenylphosphine oxide (**260**) is a by-product of this reaction and it is the production of this strong P=O bond that drives the reaction to completion.

The reaction conditions followed are based on work completed by Garegg and Samuelsson in 1980.¹³⁷ They looked at the conversion of hydroxyl-groups into iodo-groups in carbohydrates that were achieved with an inversion of configuration. The paper also puts forward a theorised mechanism that imidazole is not only present to neutralise the iodic acid that forms but to form a reactive intermediate with the triphenylphosphine (**252**). The mechanism for this transformation, along with the generally accepted mechanism for an Appel-type reaction is shown in Scheme 2.20.

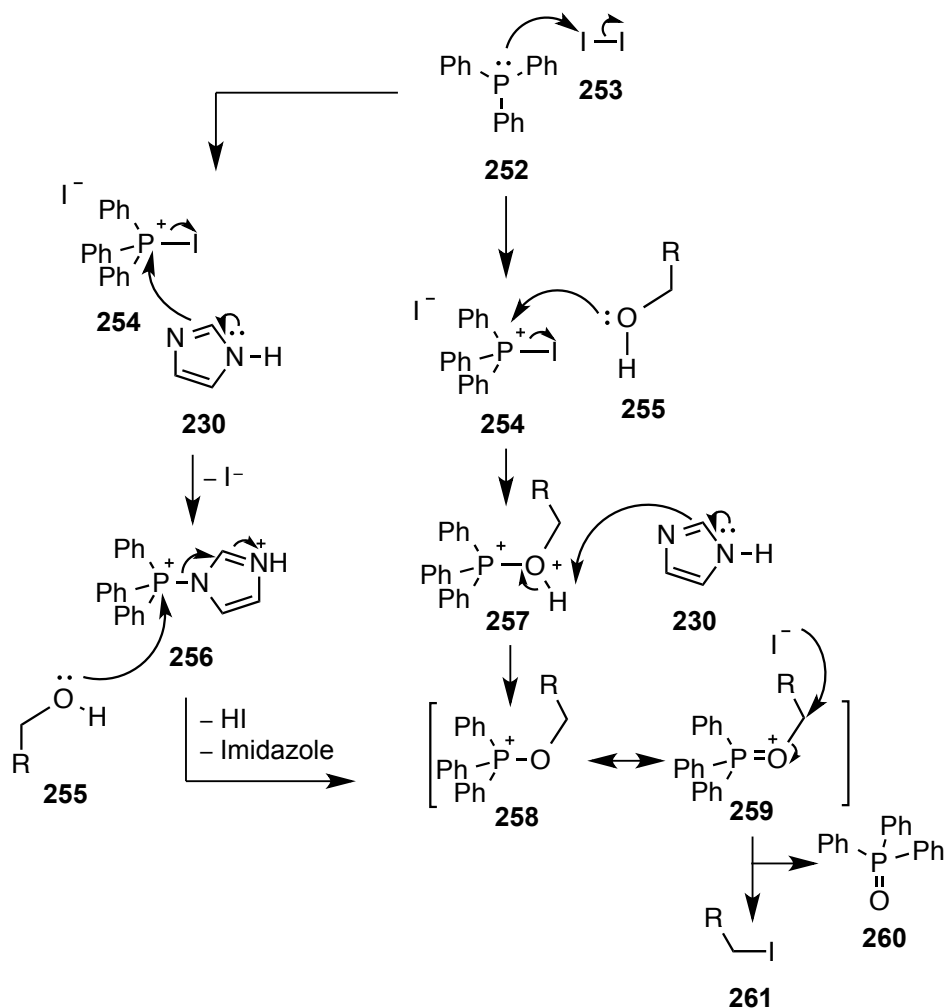

Scheme 2.20: Mechanism for the Appel-type reaction. On the left is how imidazole can form a reactive intermediate phosphine species.

Due to the wide-ranging uses of organic halides the Appel reaction and Appel-type reactions have received much interest with a lot of effort being invested into making the reaction more efficient. One method has been to deviate away from the Appel-reaction and to investigate reactions that perform the same transformation but without the production of such high levels of undesired material (the triphenylphosphine oxide). Another method has been to look at recycling the

phosphine oxide by-product, meaning that it can be used to regenerate the active species.

In 2014 the Denton group reported their advancement in regards to this reaction.¹³² Rather than using triphenylphosphine and tetrahalomethane the group looked at using polystyrene bound phosphine oxide (**262**). Using the corresponding oxalyl halide it is possible to convert the phosphine oxide to the halophosphonium salt (**263**). This meant that when the phosphine oxide is regenerated by the end of the reaction it could be recycled under the reaction conditions and there is no need for a difficult reductive step as is seen with previous examples using a supported or polymeric phosphorus reagent. As an added benefit the only by-products of converting the bound phosphine oxide to the halophosphonium salt are carbon monoxide and carbon dioxide.

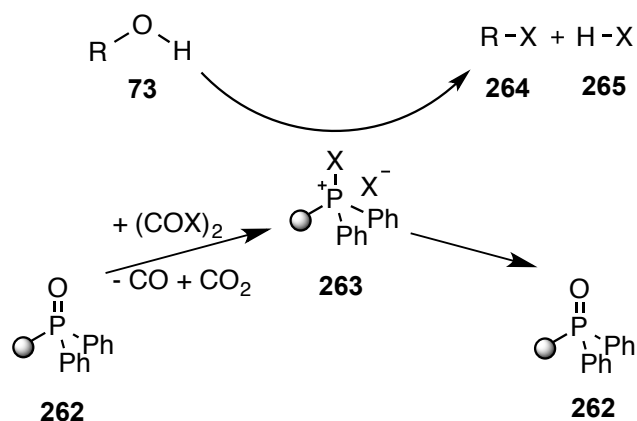

Scheme 2.21: The Denton group's use of polystyrene-bound phosphine oxide in the Appel-type reaction. Adapted from reference 138.

When synthesising compound **242**, the reaction had gone to completion within one hour. As triphenyl phosphine was used rather than a polymer bound compound

the material needed to be purified by column chromatography before the pure iodide was obtained. Despite this the yield of the reaction was 57%. Unfortunately iodo-compound **242** wasn't very stable and the material decomposed overnight even after being stored in the freezer. Because of this the remaining material was kept as the furanyl alcohol **243** as this had shown no signs of decomposition and will be brought through to the iodide (**242**) as needed.

One of changes that had been made to the Grignard reagent in this synthetic pathway compared to the previously attempted Grignard reagent is that this would form the magnesium iodide rather than the magnesium bromide. This was done despite bromide Grignard reagents being more widely available and generally being thought of as being easier to handle.¹³⁹ The reasoning behind this was that it is easier to form the Grignard reagent from the iodide compared to the bromide. This is based on the bond strength. The carbon-iodide bond is weaker than the carbon-bromide bond.¹⁴⁰

Another benefit to using the iodide is that it should allow easy access to the lithiated species through use of *tert*-butyl lithium at low temperatures. This could then go on to be used as an organometallic reagent to couple with aldehydes/ketones/imines/etc. (see Scheme 2.6) or could undergo a transmetallation reaction. Due to the presence of the methyl group on the furanyl ring the *t*-BuLi won't deprotonate at that site, meaning that the reaction should proceed without the formation of any undesired compounds.

The conversion of iodide **242** to the Grignard reagent was not attempted due to the decomposition of the synthesised material. The remaining material is still at the furanyl alcohol stage (**243**) and is stored in the freezer at -20°C and currently shows no signs of decomposition. This will be converted to the iodide, purified by column chromatography and immediately reacted to form the organometallic compound and will then take part in the subsequent coupling reagent at a later date.

2.3. Stereoselective Synthesis of 4-aryl-2-furyl Tetrahydropyrans

Previous work in the O'Brien group had established a stereoselective route to 2,6-disubstituted tetrahydropyrans. The idea used in this synthesis was that the furanyl chiral centre would epimerise under acidic conditions to give the more stable configuration over time (i.e. the thermodynamic product). This concept was one that could be utilised in the synthesis of 2,4-disubstituted tetrahydropyrans; however this synthetic route would have to be different in order to garner the desired substitution pattern.

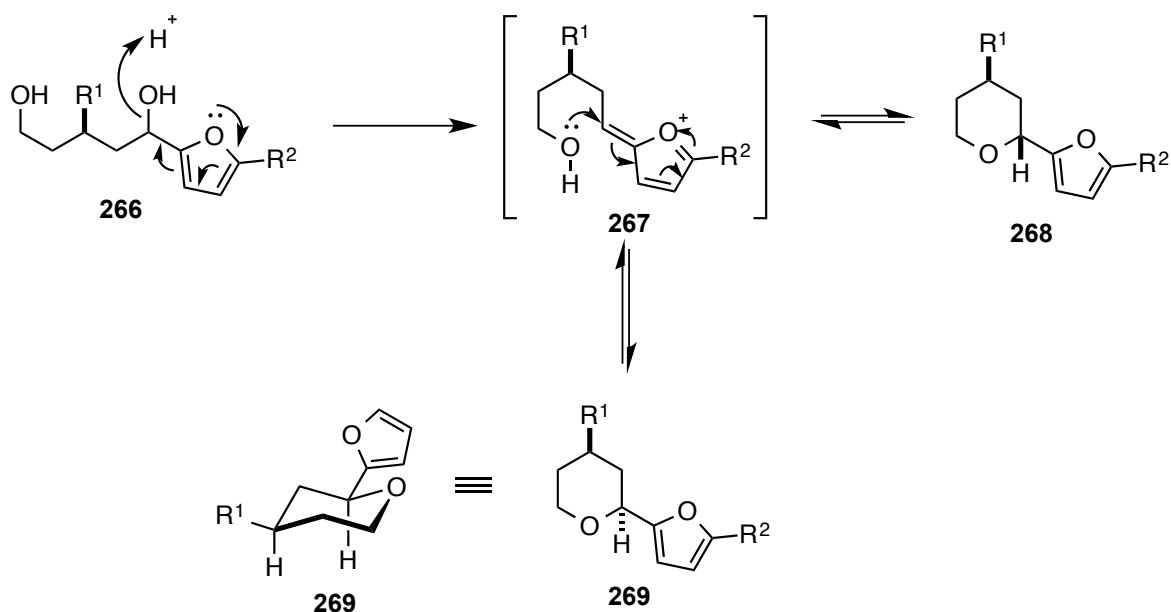

Scheme 2.22: Conceptual idea for the synthesis of 2,4-disubstituted tetrahydropyrans.

The conceptual idea of this synthesis was the development of a 1,5-diol possessing a furanyl group adjacent to one of these alcohol groups (**266**). This could then take advantage of the ability of the furanyl group to epimerise under

acidic conditions and, using the existing, non-epimerisable centre at the 4-position of the tetrahydropyran, provide stereoselectivity under thermodynamic control. The reaction would therefore ideally afford a preferred product diastereoisomer from a stereorandom mixture of diols. In theory the favoured tetrahydropyran diastereomer would place both substituents in the equatorial position on the chair conformation (**269**). The inclusion of the furanyl group is advantageous as it both facilitates the acid catalysed epimerisation allowing the stereoselectivity and also sets the molecule up for an array of possible future transformations (as highlighted in Scheme 1.28).

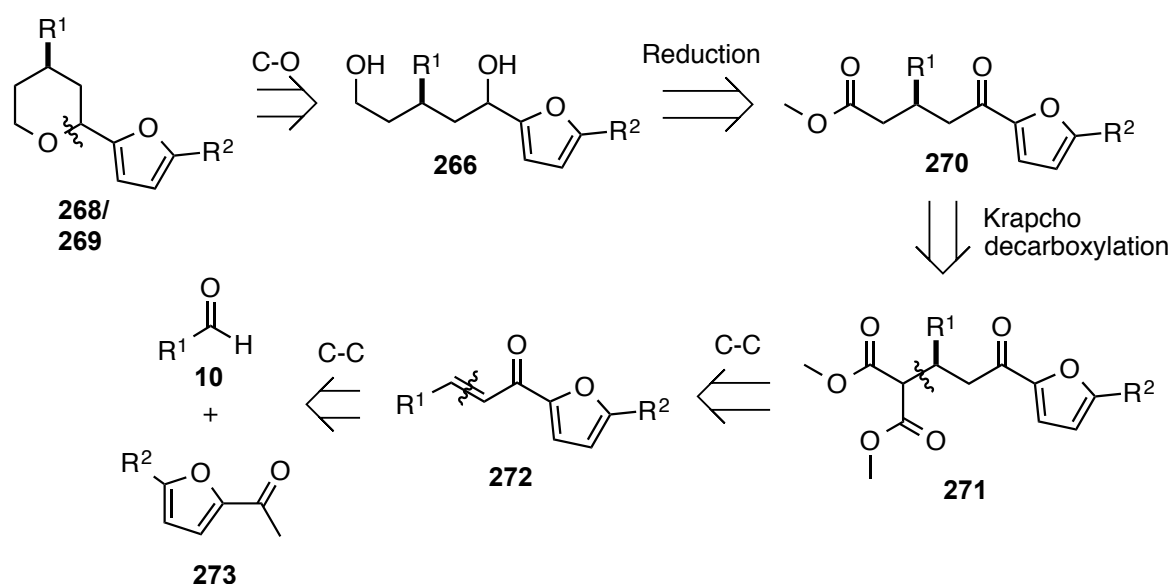

Scheme 2.23: Retrosynthetic analysis of 2,4-disubstituted tetrahydropyrans.

The first step in this synthetic route was to synthesise a series of chalcones (**272a-q**) that could be taken through a number of steps to yield the tetrahydropyran product. These chalcones were obtained from a Claisen-Schmidt condensation¹⁴¹,¹⁴² using an aldehyde that lacked a proton on the α -carbon and either acetyl furan

(**274**) or 5-methyl-2-acetylfuran (**275**). This reaction was completed in methanol and base catalysed by employing 5% sodium hydroxide solution.

The Claisen-Schmidt condensation is catalysed by base due to the acidic nature of the α -hydrogens of the enolisable carbonyl compound (i.e. **274** or **275** in this case). The nucleophilic enolate ion that forms can then add to the second carbonyl compound, which possesses electrophilic reactivity.¹⁴³ The initial product of this reaction is the β -hydroxycarbonyl compound. This reaction is reversible but under these reaction conditions a subsequent E_{1cb} reaction can be seen producing the α,β -unsaturated compound. This elimination of water shifts the position of equilibria and favours product formation.¹⁴⁴

Pivalaldehyde was also used to incorporate the *tert*-butyl functionality and furfural and 2-methylfurfural were used to introduce a second furanyl group. These were potentially interesting compounds that did not possess the enolisable proton on the α -carbon, meaning they were suitable for this reaction. The yields seen from this ranged from low to very high and this was dependent on which aldehyde was employed. The substituted benzaldehydes all gave yields that exceeded 70%. It was when using alternative aldehydes that the lower yields were seen. In the cases where pivalaldehyde was used this is likely due to the loss of the highly conjugated system that is seen when substituted benzaldehydes are used.

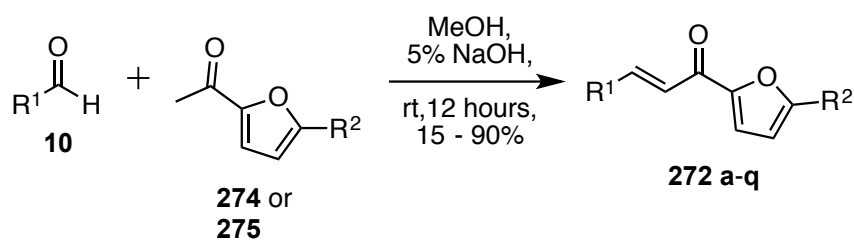

Scheme 2.24: Chalcone formation *via* a Claisen-Schmidt condensation.

Entry	Compound	R ¹	R ²	Yield ^a
1	272a	C ₆ H ₅	H	80%
2	272b	4-C ₆ H ₄ -Cl	H	85%
3	272c	4-C ₆ H ₄ -OMe	H	72%
4	272d	4-C ₆ H ₄ -CH ₃	H	82%
5	272e	3,4-C ₆ H ₃ -(OMe) ₂	H	75%
6	272f	4-C ₆ H ₄ -Br	H	95%
7	272g	2,4,5-C ₆ H ₂ -(OMe) ₃	H	77%
8	272h	4-C ₆ H ₄ -Br	Me	80%
9	272i	C ₆ H ₅	Me	71%
10	272j	4-C ₆ H ₄ -CH ₃	Me	71%
11	272k	4-C ₆ H ₄ -Cl	Me	85%
12	272l	<i>Tert</i> -butyl	H	20%
13	272m	Furan	H	15%
14	272n	Furan	Me	51%
15	272o	Methylfuran	H	62%
16	272p	Methylfuran	Me	62%
17	272q	2-C ₆ H ₄ -Cl	H	68%

^a: Isolated yield after purification either via recrystallisation from hot ethanol or via column chromatography.

Compounds **272a-e** and **272q** were synthesised by Dr O'Brien.

Table 2.4: Chalcones produced for the synthesis of 2,4-disubstituted tetrahydropyrans.

All chalcones were purified by recrystallisation from hot ethanol, except compounds **272l** and **272q**, which did not recrystallise and so were purified via column chromatography using dichloromethane as the solvent. Due to the low yields for **272l-p** seen, it was only **272a-k** that were taken through to the tetrahydropyran product. **272q** was taken through the synthetic route; however issues were seen throughout the process in terms of successful purification and so the use of this compound was limited.

The next step of the reaction sequence involved a Michael addition of dimethyl malonate (**276**) to the chalcones to yield the relevant keto-diesters (**271a-k**).

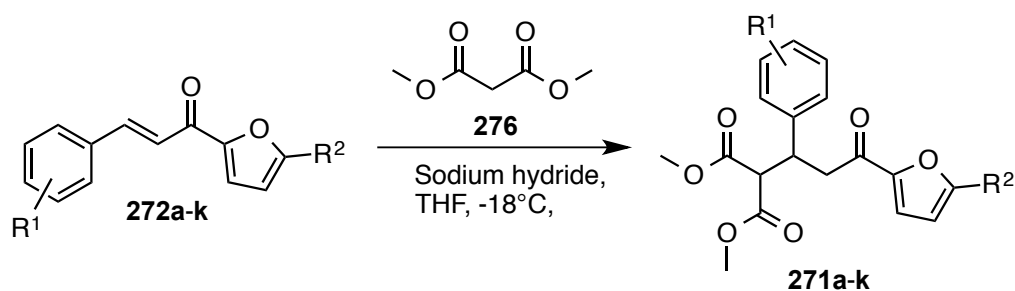

Scheme 2.25: Michael addition of dimethyl malonate using sodium hydride.

Entry	Compound	R ¹	R ²	Yield ^a
1	271a	H	H	60%
2	271b	4-Cl	H	N/A*
3	271c	4-OMe	H	49%
4	271d	4-CH ₃	H	59%
5	271e	3,4-OMe	H	N/A*
6	271f	4-Br	H	N/A*
7	271g	2,4,5-OMe	H	N/A*
8	271h	4-Br	Me	N/A*
9	271i	H	Me	N/A*
10	271j	4-CH ₃	Me	N/A*
11	271k	4-Cl	Me	N/A*

^a: Isolated yields after purification via column chromatography.

*: These compounds were not purified at this stage but rather taken through the next stage of the reaction and a yield calculated over both steps then.

271g was synthesised by Dr O'Brien.

Table 2.5: Michael addition products from the synthesis of 2,4-disubstituted tetrahydropyrans.

Michael addition reactions are facile and occur where a nucleophilic species adds across an activated, electrophilic alkene/alkyne. The reaction is base facilitated. In the example shown in Scheme 2.25 the base deprotonates the dimethyl malonate to generate the enolate anion and this reacts with the chalcone in a conjugate addition reaction. Upon workup a proton is transferred to generate the keto-diester **271**. The nucleophile attacks at the β -carbon because there is a preference for 1,4-conjugate addition compared to a 1,2-conjugate addition.¹⁴⁵ This preference for attack at the β -carbon can also be explained by the “hard and soft acids and bases principle” (HSAB principle). This principle was propounded in 1963 by Pearson¹⁴⁶ and classifies chemical species as either hard or soft. Hard species possess small atomic radii, high effective nuclear charges and low polarisability. The reverse is true for soft species. The HSAB principle states that acids show a greater affinity for bases of the same class and a hard-soft combination is destabilised.¹⁴⁷ In the case detailed in Scheme 2.26 the organic donor atom is the carbon atom, which is a soft base. This is because the electron density is spread out, meaning that there is less electrostatic stabilisation. Based on the HSAB principle this soft base will attack preferentially at the soft acid site in the chalcone compound over the hard species (soft species = C-C double bond; hard species = carbonyl group).

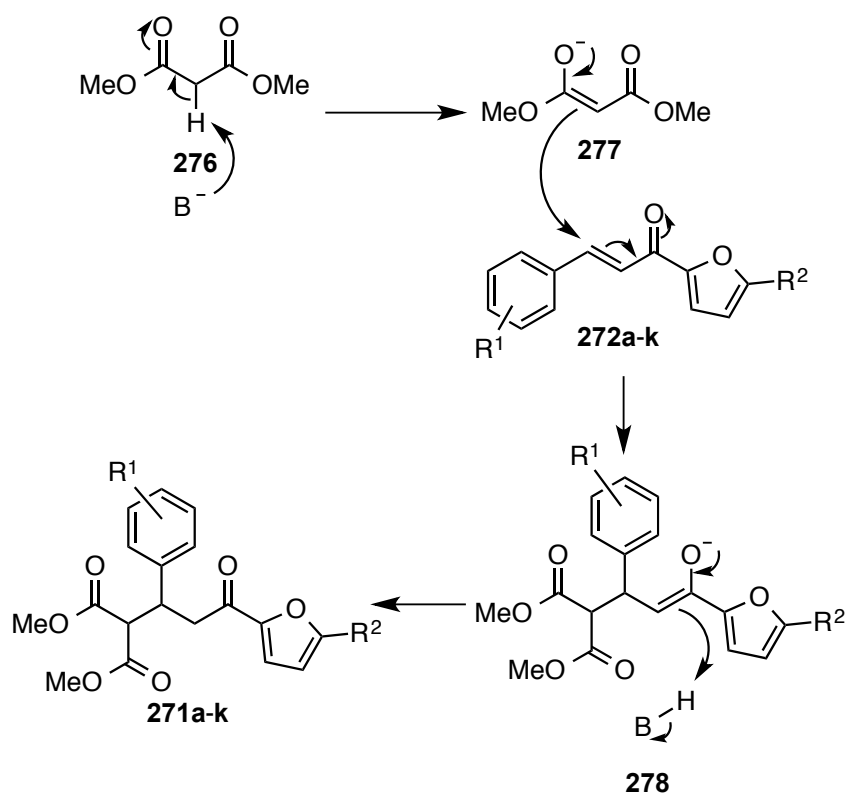

Scheme 2.26: Mechanism of the conjugate addition of dimethyl malonate to the starting chalcones (272a-k).

Though this reaction went to completion and yielded the desired keto-diester there was always the issue of mineral oil being present in the NMR spectra. This came from the sodium hydride and analysis using TLC showed that the mineral oil eluted very closely to the desired product despite a number of solvents being tested. Excess dimethyl malonate was also present at the end of the reaction. Rather than purify the crude material at this stage it was taken through a Krapcho decarboxylation to yield the keto-ester.

Although this method was successful and was used in the initial synthesis of these compounds the residual presence of mineral oil was always noted. Column

chromatography was always an option to purify this material, but it would be preferential to avoid this, especially on larger scales, to minimise the cost and time of the synthetic route. Due to this an alternative method for the Michael addition was sought.

With this in mind methodologies within the literature were examined and a method described by Rosnati and co-workers in a 1981 paper seemed promising.¹⁴⁸ The paper described the reactions of phenolic Michael donors with α -bromo Michael acceptors using potassium carbonate. This is something that has also been achieved under solvent free conditions using a technique known as high-speed vibration milling (within the reaction vessel is placed a number of stainless steel balls and these are vigorously agitated).¹⁴⁹ Due to a lack of the necessary machinery it was not possible to utilise a high-speed vibration milling method; however this did show that the reaction being attempted with very similar starting compounds was possible.

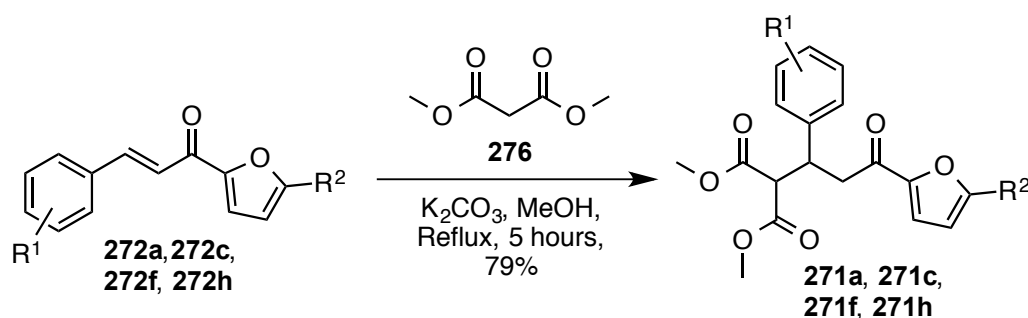

Scheme 2.27: Conjugate addition using potassium carbonate.

Rosnati's methodology was applied on the scaled up conjugate additions and proved very effective. Initially compounds were purified by column

chromatography and all yields exceeded 65%. However, column chromatography proved unnecessary as the excess dimethyl malonate would undergo the Krapcho decarboxylation in the next step of the reaction sequence, yielding the volatile product methyl acetate. This compound would be far easier to remove and wouldn't necessitate column chromatography. The Krapcho decarboxylation was used to remove one of the ester functionalities from compounds **271a-k**, yielding the keto-ester product (**270a-k**).

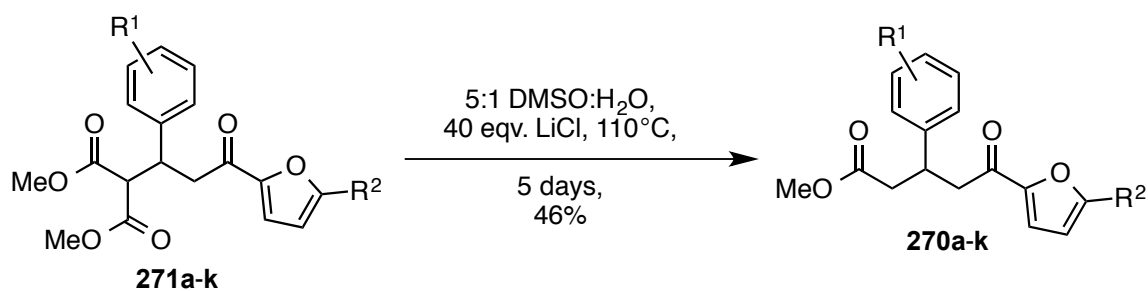

Scheme 2.28: Krapcho decarboxylation of keto-diester.

Entry	Compound	R ¹	R ²	Yield ^a
1	270a	H	H	46%
2	270b	4-Cl	H	6%*
3	270c	4-OMe	H	10%
4	270d	4-CH ₃	H	29%
5	270e	3,4-OMe	H	14%*
6	270f	4-Br	H	12%*
7	270g	2,4,5-OMe	H	45%*
8	270h	4-Br	Me	25%
9	270i	H	Me	16%*
10	270j	4-CH ₃	Me	15%*
11	270k	4-Cl	Me	13%*

^a: Isolated yields after purification via column chromatography.

*: Yields calculated are over two steps – the Michael addition and the Krapcho decarboxylation.

270g was synthesised by Dr O'Brien.

Table 2.6: Krapcho decarboxylation products from the 2,4-disubstituted tetrahydropyran synthesis.

In 1967, Krapcho reported on a novel synthetic procedure that transformed geminal dicarboxy compounds into the corresponding ethyl ester.¹⁵⁰ This was achieved using sodium cyanide in dimethyl sulfoxide (DMSO) and heating to reflux. The reaction gave good yields, though in one example stated the product yield was 25%; however they recovered a yield of 60% for the starting material.

Despite the usefulness and efficiency of this reaction, alternatives to sodium cyanide were investigated. In 1973, Krapcho detailed a reaction to convert geminal diesters to the corresponding ester using sodium chloride in wet DMSO.¹⁵¹ This removed the need for sodium cyanide and replaced it with an alternative that was easy-to-handle and cheap. In all cases the yields reported were above 85% but the amount of water added to wet the DMSO varied depending on the substrate. This averaged out at around 2 moles of water per mole of diester.

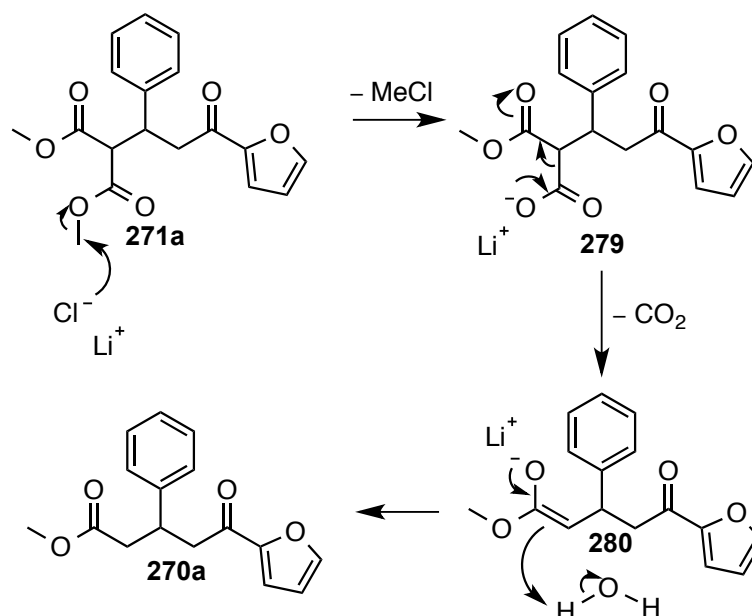

Scheme 2.29: Mechanism of the Krapcho decarboxylation reaction using a chloride anion and **271a** as substrate examples.

When using a chloride salt with a diester (**271a**) the chloride anion attacks the alkyl group of one of the esters in a S_N2 reaction to yield the intermediate **279**. As this is a S_N2 reaction larger ester groups can affect the rate of reaction. The methyl ester proceeds relatively rapidly as it is a relatively small group, whereas a bulkier substituent would decrease the rate of reaction. Intermediate **279** then loses a molecule of carbon dioxide to yield the enolate anion **280** that is protonated by water to yield the desired product (**270a-k**).¹⁵²

A series of chloride salts and solvent systems were tested for use in the Krapcho decarboxylation.

Entry	Solvent System	Salt	Result
1	DMSO	1:1 NaCl:LiCl	21% over 2 steps
2	DMSO	NaCl	No reaction
3	DMSO	LiCl	35% over 2 steps
4	5:1 DMSO:H ₂ O	NaCl	No reaction
5	5:1 DMSO:H ₂ O	LiCl	45% over 2 steps

Table 2.7: Solvent systems and salts tested for the Krapcho decarboxylation.

After the Krapcho decarboxylation, an average yield of 26% was seen. This yield was over two steps (malonate addition and subsequent decarboxylation), but this was still relatively low. The key reason for the low yields being seen was based on one of the impurities seen from the Krapcho reaction. Upon purification by column chromatography the main impurity seen from this reaction was isolated. This impurity was isolated in yields of about 25% and ¹H-NMR analysis showed that

this was the corresponding chalcone. Crude $^1\text{H-NMR}$ after the Krapcho reaction had taken place showed ratios of 3:1 and in some cases 3:2 of desired product and chalcone.

Due to the chalcone being reformed in such high yields an alternative route was investigated. The first step in this alternative pathway was to convert the diester **271a** to the corresponding diacid **281**. This was achieved using base hydrolysis with 1M potassium hydroxide, followed by acidification with HCl. This reaction went in a moderate yield of 44%. This compound was then heated in DMSO for 12 hours to lose a molecule of carbon dioxide. This should have yielded the carboxylic acid **282** that in theory could then have been taken to the next step of the synthetic route and reduced to the 1,5-diol; however the $^1\text{H-NMR}$ of this material showed the presence of the original starting chalcone and also seemed to have degraded as a number of impurities were seen by $^1\text{H-NMR}$ and TLC. Coupled with this was the fact that the impure material obtained at the end of this two-step reaction process was only a 19% yield, one that was lower than seen in the original Krapcho decarboxylation step.

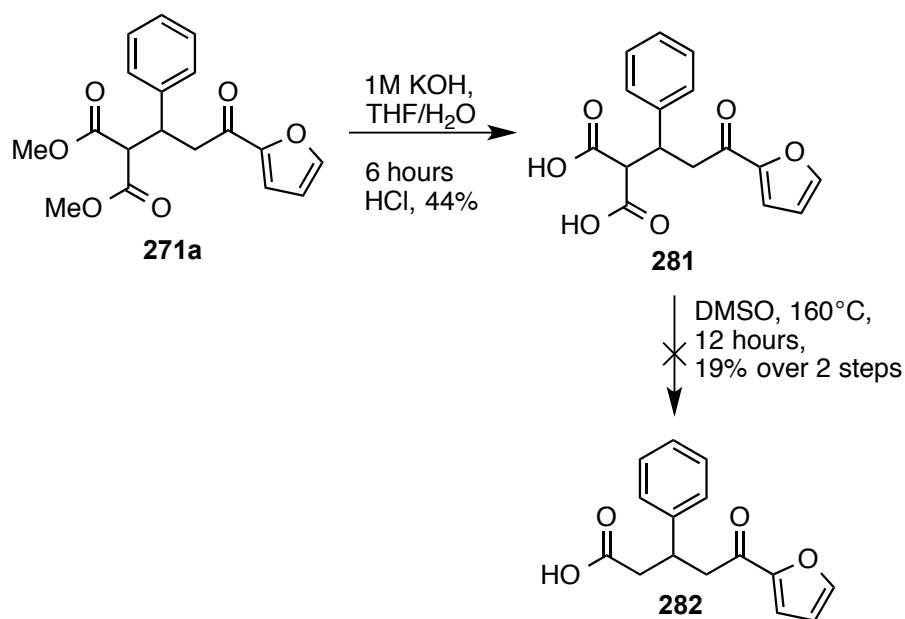

Scheme 2.30: Route investigated as an alternative to the Krapcho decarboxylation step.

Due to this no alternative route was used; rather all the keto-diesters (**271a-k**) were transformed to the corresponding keto-ester (**270a-k**) using the Krapcho decarboxylation method and the recovered chalcone material was stored and recycled.

Upon obtaining the purified keto-ester the aim was to convert this to the corresponding 1,5-diol in the penultimate step of the reaction sequence.

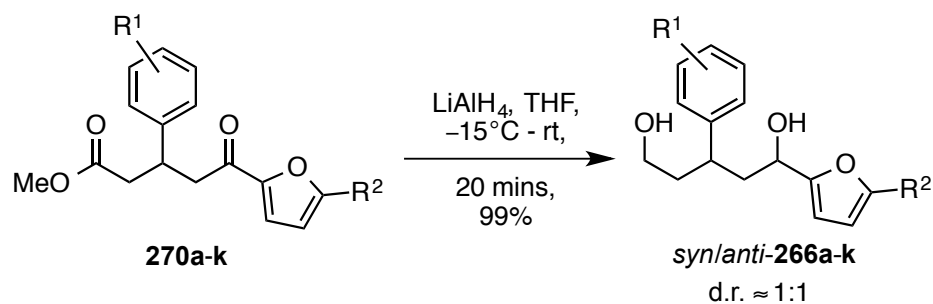

Scheme 2.31: Lithium aluminium hydride reduction of keto-esters to form the 1,5-diol moieties.

Entry	Compound	R ¹	R ²	Yield ^a	d.r.
1	266a	H	H	99%	1.43 : 1
2	266b	4-Cl	H	99%	1.33 : 1
3	266c	4-OMe	H	96%	1.33 : 1
4	266d	4-CH ₃	H	40%	1.33 : 1
5	266e	3,4-OMe	H	41%	1.25 : 1
6	266f	4-Br	H	91%	1.32 : 1
7	266g	2,4,5-OMe	H	97%	1.54 : 1
8	266h	4-Br	Me	28%	1.42 : 1
9	266i	H	Me	73%	1.42 : 1
10	266j	4-CH ₃	Me	99%	1.42 : 1
11	266k	4-Cl	Me	69%	1.33 : 1

^a: Isolated yields after purification *via* column chromatography.

266g was synthesised by Dr O'Brien.

Table 2.8: Diols synthesised along the synthetic route to 2,4-disubstituted tetrahydropyrans.

This was accomplished through the use of lithium aluminium hydride (LiAlH_4) and, in the majority of cases, this proved to be a very effective reduction method resulting in yields exceeding 90%. Despite the success of this step, issues were encountered when there was a bromine substituent on the aromatic phenyl ring as an impurity was being seen in the $^1\text{H-NMR}$ spectrum.

The similarity in peak pattern suggested that the impurity was a related compound and when compared to compound **266a** the minor compound matched exactly. This suggested that during the reduction of the keto-ester the aryl bromide had also been reduced. This effect is something that was reported in 1948 by Johnson, Blizzard and Carhart when using tetrahydrofuran or diethyl ether as the solvent system for the reaction with alkyl halides. They refluxed the reaction mixture and this resulted in the hydrogenolysed product.¹⁵³ This area received further interest in 1969 when Brown and Krishnamurthy looked at the reaction with aryl bromides.¹⁵⁴ They found similar effects during the course of the reaction; however there was no need for heat. Brown went on further to test the reaction rates using differing alkyl and aryl halides. Some trends were seen during the course of this investigation. The rate of reaction with primary halides was more rapid than with secondary halides¹⁵³ and the highest rate of reaction was seen with aryl iodides, followed by aryl bromides, then aryl chlorides and a slow rate was seen with aryl fluorides.¹⁵⁴

This explained why, in the reduction of the keto-esters to the corresponding diols, this effect had only been seen with the 4-bromo substituted phenyl rings and not the 4-chloro examples. In order to overcome this the reaction was ran for only 10

minutes in these cases and this proved successful as none of compound **266a** was seen and the yields obtained were comparable with the other diols.

An alternative route was found where sodium borohydride was the reducing agent. In 1963, Brown reported on the reduction of esters using sodium borohydride.¹⁵⁵ This reaction took place in refluxing methanol and the reaction was reported as vigorous. Further developments led to the reaction being completing in refluxing THF, with a small quantity of methanol being added dropwise.¹⁵⁶ This reaction proved to be very effective; however it showed no obvious advantages over the use of lithium aluminium hydride.

The final step in this reaction sequence was to cyclise the diol under acidic conditions in order to obtain the 2,4-disubstituted tetrahydropyrans.

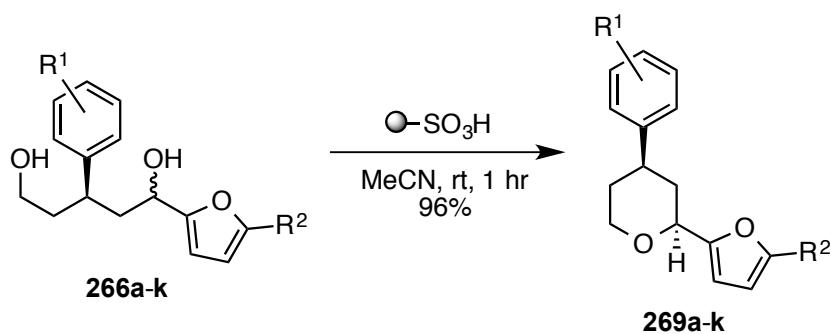

Scheme 2.32: Cyclisation of 1,5-diols under acidic conditions to forge the 2,4-disubstituted tetrahydropyran structure.

Entry	Compound	R ¹	R ²	d.r.	Yield ^a
1	269a	H	H	22:1	73%
2	269b	4-Cl	H	19:1	23%
3	269c	4-OMe	H	10:1	59%
4	269d	4-CH ₃	H	20:1	83%
5	269e	3,4-OMe	H	15:1	82%
6	269f	4-Br	H	10:1	96%
7	269g	2,4,5-OMe	H	25:1	93%
8	269h	4-Br	Me	22:1	70%
9	269i	H	Me	20:1	83%
10	269j	4-CH ₃	Me	15:1	85%
11	269k	4-Cl	Me	10:1	68%

^a: Isolated yields after purification *via* column chromatography after using the crude ¹H-NMR to determine the d.r.

269g was synthesised by Dr O'Brien.

Table 2.9: 2,4-disubstituted tetrahydropyrans synthesised and their respective diastereomeric ratios.

A series of acids were tested for this reaction and in these seven test cases the reaction was ran in deuterated acetonitrile in order to allow the real-time analysis of the reaction by $^1\text{H-NMR}$. After 10 minutes the reaction was analysed to determine whether the reaction was occurring or not. If successful, the reaction was left for one hour to allow for epimerisation.

Entry	Acid	Time	Result and Purification
1	Catalytic quantity of <i>p</i> -toluenesulfonic acid	1 hour	Successful reaction. Purified using a silica plug
2	1 drop of acetic acid	10 mins	No reaction
3	6 drops of acetic acid	10 mins	No reaction
4	1 drop of trifluoroacetic acid (TFA)	1 hour	Successful reaction. Purified by column chromatography
5	Catalytic quantity of polymer-supported sulfonic acid	1 hour	Successful reaction. Filtered
6	5 drops of 1:1 acetic acid:TFA	10 mins	No reaction
7	5 drops of 1:6 acetic acid:TFA	1 hour	Successful reaction. Purified by column chromatography

Table 2.10: Acids tested for use in the cyclisation of 1,5-diols to the corresponding tetrahydropyrans.

Upon evaluation of these acids it was decided to use the polystyrene-supported sulfonic acid (entry 5). This was mainly because of the ease of work-up. Filtering and washing the beads meant that very little material was lost and so very high yields of the tetrahydropyran product could be obtained. These yields were higher

than those obtained from other methods that had been ran through a column or plug in order to remove the acid.

After finding a suitable acid catalyst for the reaction the cyclisation of the 1,5-diols (**266a-k**) began. The test reactions had been run for up to 1 hour and showed a high ratio in favour of one diastereoisomer over the other. In order to show that the reaction was epimerising over time, rather than the final ratio being produced immediately, the reaction was monitored by $^1\text{H-NMR}$ at set intervals. The reaction was analysed after ten minutes, twenty-five minutes and forty-five minutes. An added benefit to using the polymer-supported sulfonic acid was that monitoring the reaction at certain times was easily achieved as the acid was filtered off, the analysis was performed and then the acid was again added to the reaction mixture under identical conditions.

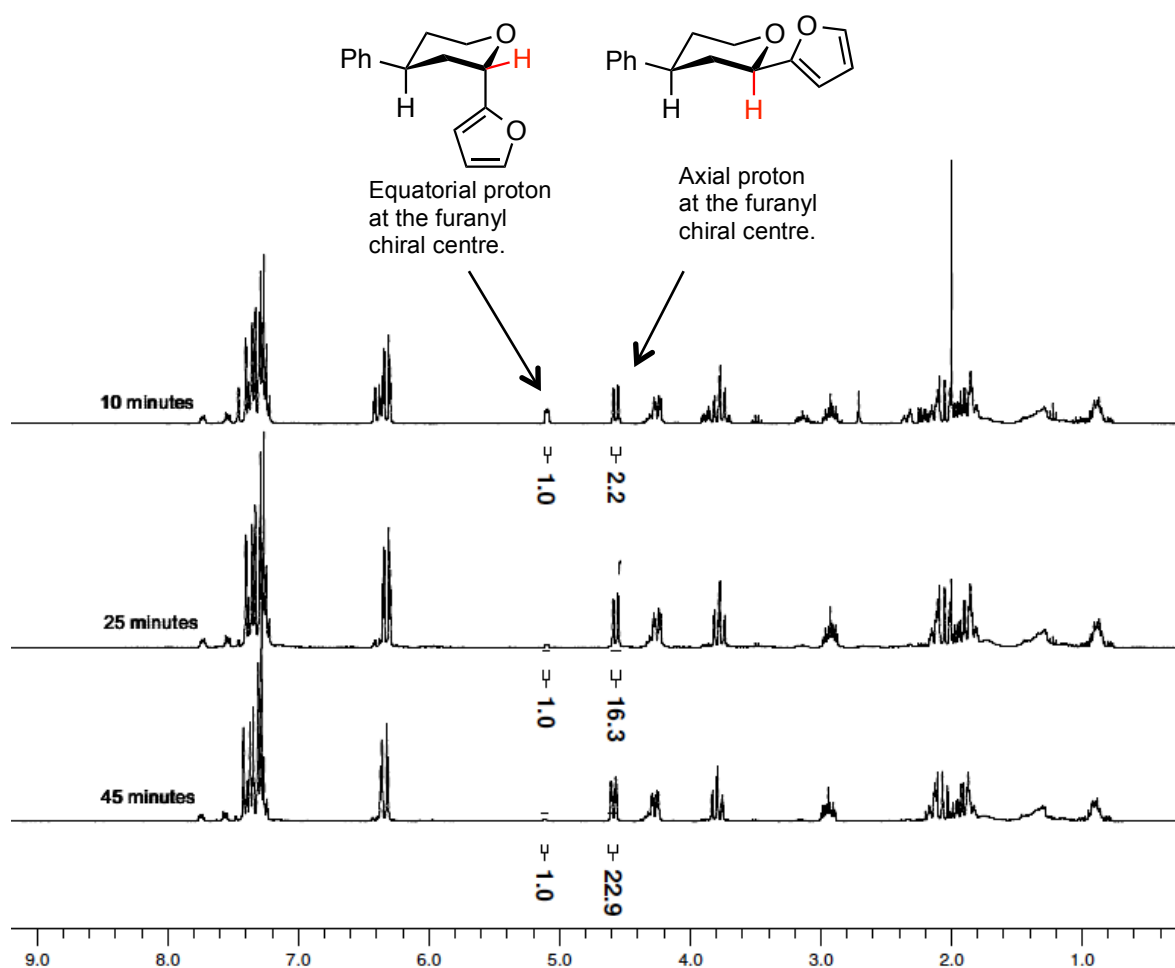

Figure 2.3: ^1H -NMR spectra of the cyclisation of **266a** to **269a**. The reaction was monitored after 10 minutes, 25 minutes and 45 minutes. Integrations of the two key peaks show the change in ratio of the two diastereoisomers seen over time.

Figure 2.3 shows the three spectra obtained over the course of converting **266a** into **269a** under acidic conditions. After 10 minutes, the initial cyclisation reaction had only just gone to completion and this is shown in the ratio of diastereoisomers. In the minor diastereomer, that which possesses the aryl ring in the equatorial position and the furanyl ring in the axial position the proton at the furanyl chiral centre is easily identifiable at around 5 ppm. In the major diastereoisomer, that which possesses both the aryl ring and the furanyl ring in the equatorial positions

the proton at the furanyl chiral centre is slightly lower at around 4.5 ppm. After ten minutes the ratio of these two peaks is about 2:1 in favour of the diequatorial compound.

After a further 15 minutes has elapsed this ratio has increased to 16:1 and after a total time of 45 minutes this ratio has reached 22:1 in favour of the diequatorial compound.

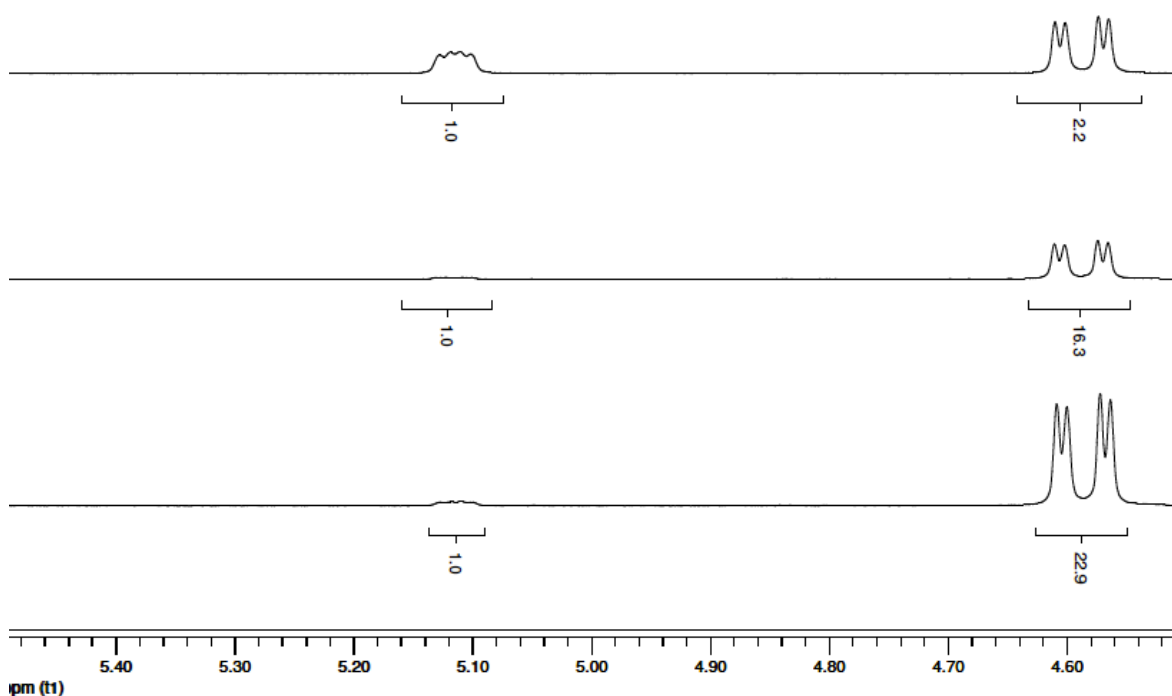
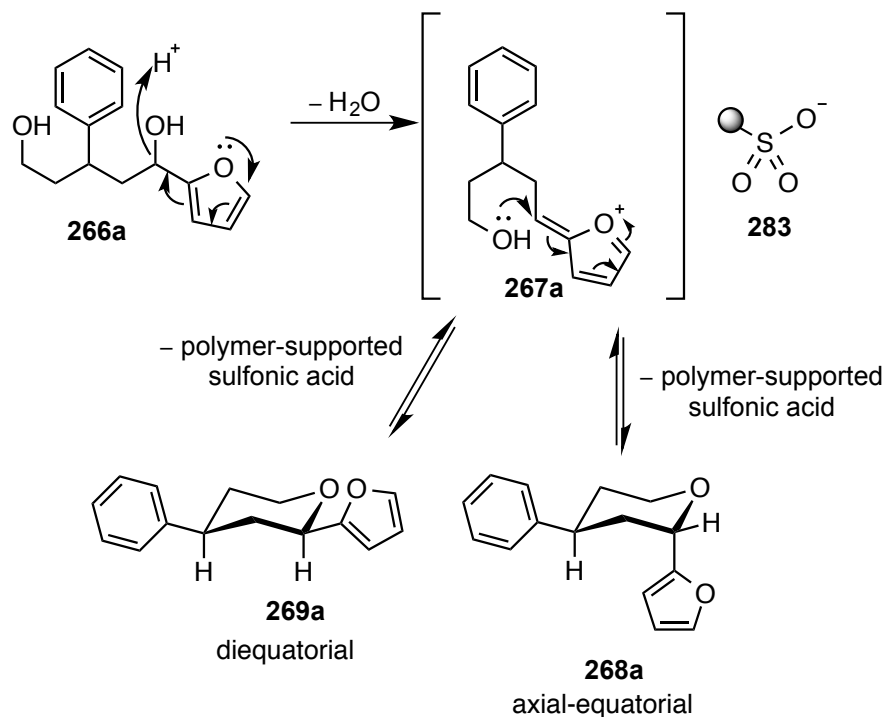

Figure 2.4: Expanded spectra for the cyclisation of **266a** to **269a**.

This increase in diastereomeric ratio shows that the epimerisation of the furanyl chiral centre occurs under acidic conditions and, under thermodynamic control, allows the emergence of one diastereomer over the other as the major product of the reaction. This epimerisation is able to occur because of the cyclisation step

being reversible under these conditions and because of the electron-rich nature of the furanyl group.



Scheme 2.33: Mechanism for the cyclisation of 1,5-diol **266a** to the corresponding tetrahydropyran.

The electron-rich nature of the furanyl group facilitates the elimination of water under the acidic conditions of the reaction. This generates the oxonium ion **267a** where the remaining hydroxyl group can attack the carbon-carbon double bond and form the tetrahydropyran product. The reversibility of this reaction means that over time the diequatorial **269a** is favoured due to the stability of having both substituents in an equatorial position.

In order to prove beyond any doubt that the epimerisation is facilitated by the acidic conditions of the reaction, diol **266a** was cyclised under basic conditions. This prevents epimerisation and means that both diastereoisomers of the alcohol are cyclised, giving both diastereoisomers of the tetrahydropyran product. This would also allow the production of significant amounts of the minor diastereoisomer to obtain clear NMR data. This NMR data could then be compared to the NMR spectra obtained from the acid-catalysed cyclisation and peaks could then be assigned.

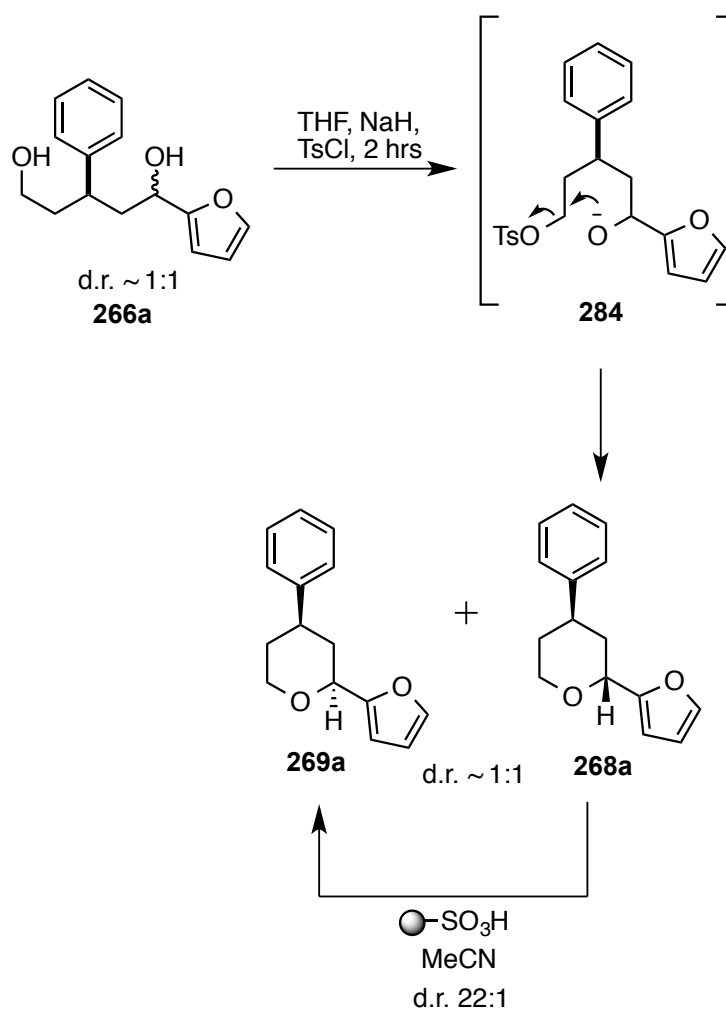

Scheme 2.34: Cyclisation of a 1,5-diol under basic conditions.

This was achieved in a one-pot reaction using sodium hydride and tosyl chloride in THF. Both **268a** and **269a** were obtained in an approximately 1:1 ratio, and this showed that epimerisation of the furanyl chiral centre only occurred under acidic conditions. Careful column chromatography yielded a small quantity of pure **268a**, a small quantity of **269a** and a substantial quantity of the mixed fractions.

After characterisation, **268a** was subjected to the established acidic conditions of the cyclisation reaction. This allowed epimerisation and the 1:1 mixture of tetrahydropyran diastereomers increased to reach ratios that had been seen previously (i.e. 22:1 in favour of the diequatorial compound).

The final stage of investigation into the disubstituted tetrahydropyrans that had been produced was to unambiguously determine the stereochemistry of the two diastereoisomers produced. Previously the assignments had been made based on the NMR coupling constants and the chemical shifts seen in the $^1\text{H-NMR}$ spectrum. From the tosylation-cyclisation both stereoisomers could be analysed by nuclear Overhauser effect spectroscopy (NOESY). The nuclear Overhauser effect (nOe) allows information to be garnered on which protons are spatially close together.¹⁵⁷

The NOESY spectrum of the major diastereoisomer formed shows several nOe enhancements. These match the idea of a diequatorial compound because the axial hydrogens shown in Figure 2.5 would be close in space. There is also an nOe enhancement between the axial and equatorial hydrogen on C-6 (shown in red).

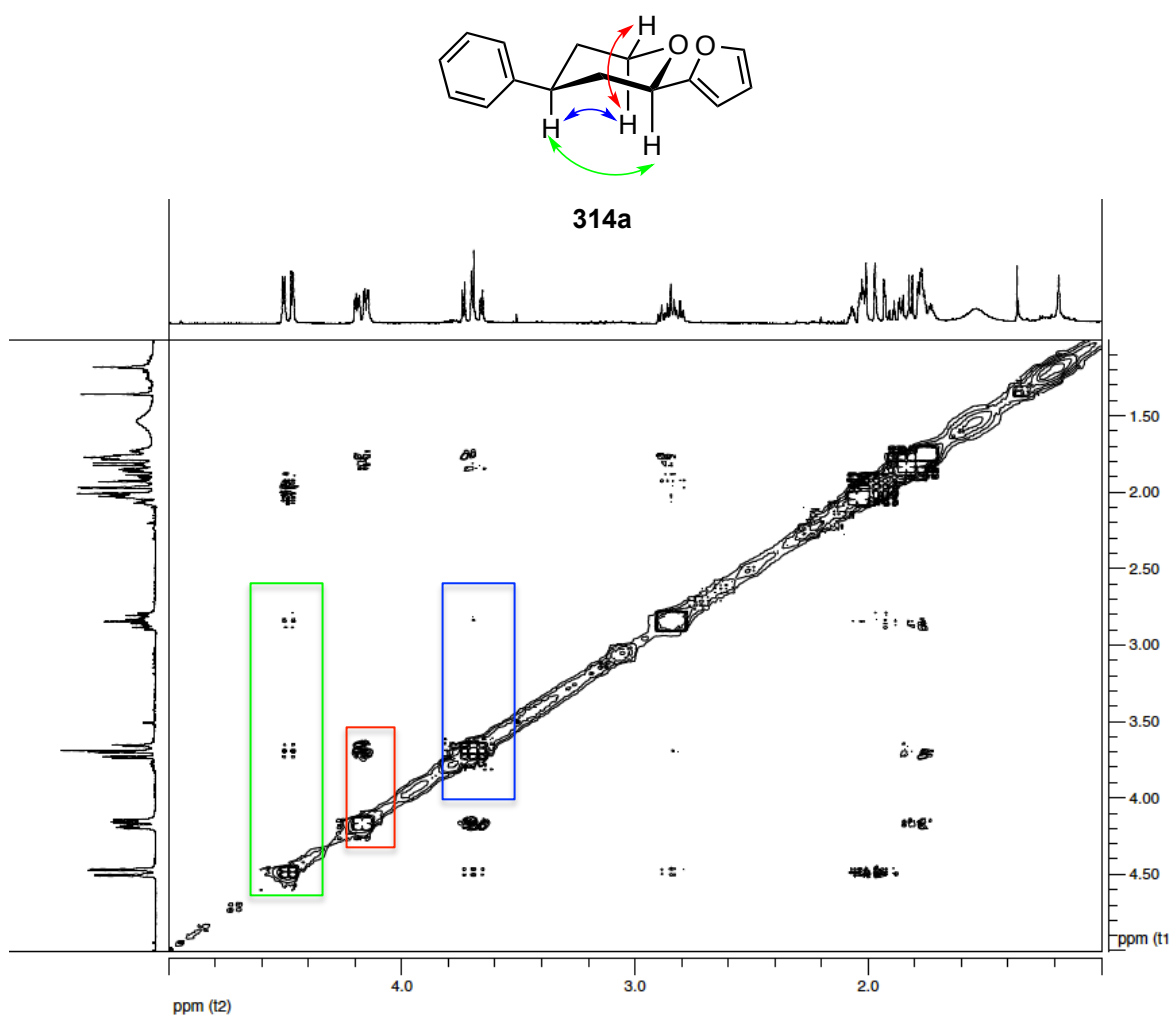

Figure 2.5: 2D-NOESY spectrum of tetrahydropyran **269a**.

In comparison to this the NOESY spectrum of the minor diastereoisomer seen in the cyclisation of diol **266a** shows only one nOe enhancement and that is for the axial and equatorial protons shown in fuchsia. The furanyl group in this compound is axial, rather than equatorial and the equatorial proton is at too great a distance for a nOe enhancement to be seen. This lack of an observation does not prove the stereochemistry beyond any doubt but combined with the J-values obtained from the $^1\text{H-NMR}$ the evidence does suggest that this is the case.

A change in the puckering of the ring from this adjustment in substituent position may be the cause of seeing no nOe between the axial proton on C-6 and the axial proton on C-4. This change in puckering may slightly adjust the distance between these two protons and, as the cross relaxation is dependent on distance to the power of six, a very small adjustment can have quite a large effect.

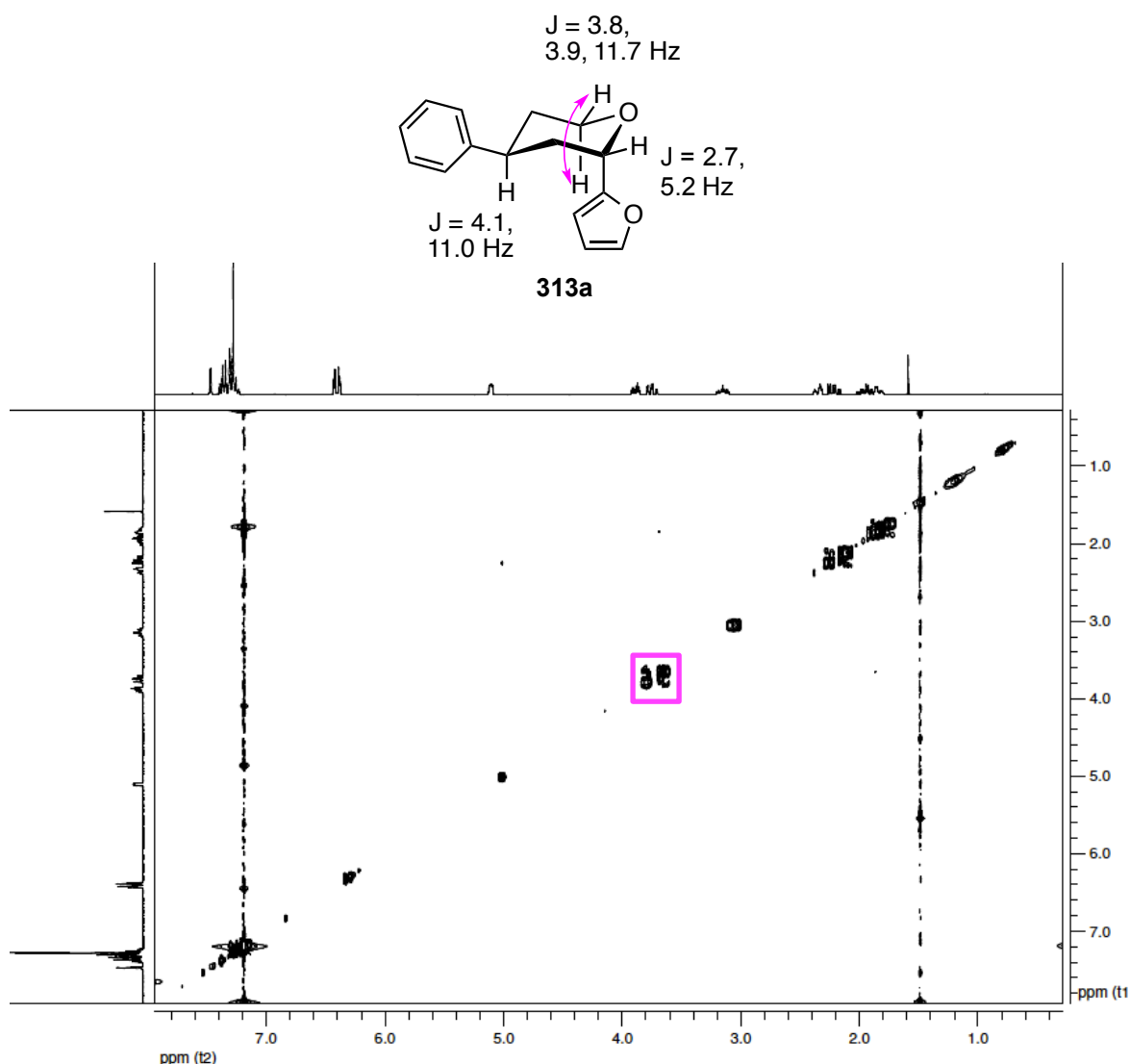

Figure 2.6: 2D-NOESY spectrum of tetrahydropyran **268a**.

Although this evidence was very compelling, efforts were made to generate a crystalline disubstituted tetrahydropyran as this could be used to obtain an X-ray

crystal structure of the major diastereoisomer. Initially this was the reason why the 4-bromo substituted examples **269f** and **269h** were synthesised; however these did not yield the desired crystals. Fortuitously after being stored in the freezer for a substantial period of time the dimethoxy substituted compound **269e** yielded a crystalline product. This was sent to National Crystallography Service at the University of Southampton and an X-ray crystal structure was obtained (shown in Figure 2.7).

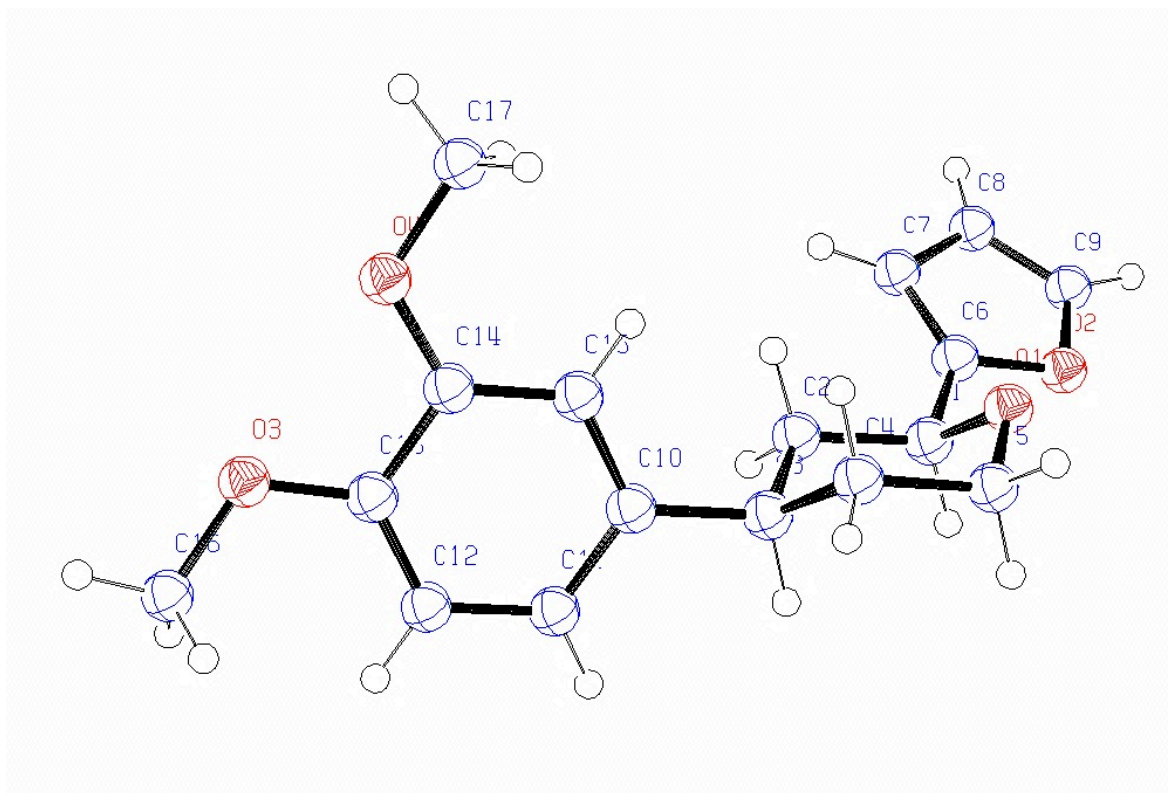

Figure 2.7: X-ray crystal structure of **269e**. This confirms that the major diastereoisomer seen from the cyclisation reaction is the diequatorial compound.

When the 2,4,5-trimethoxy compound **269g** was successfully synthesised this too proved to be a crystalline structure.

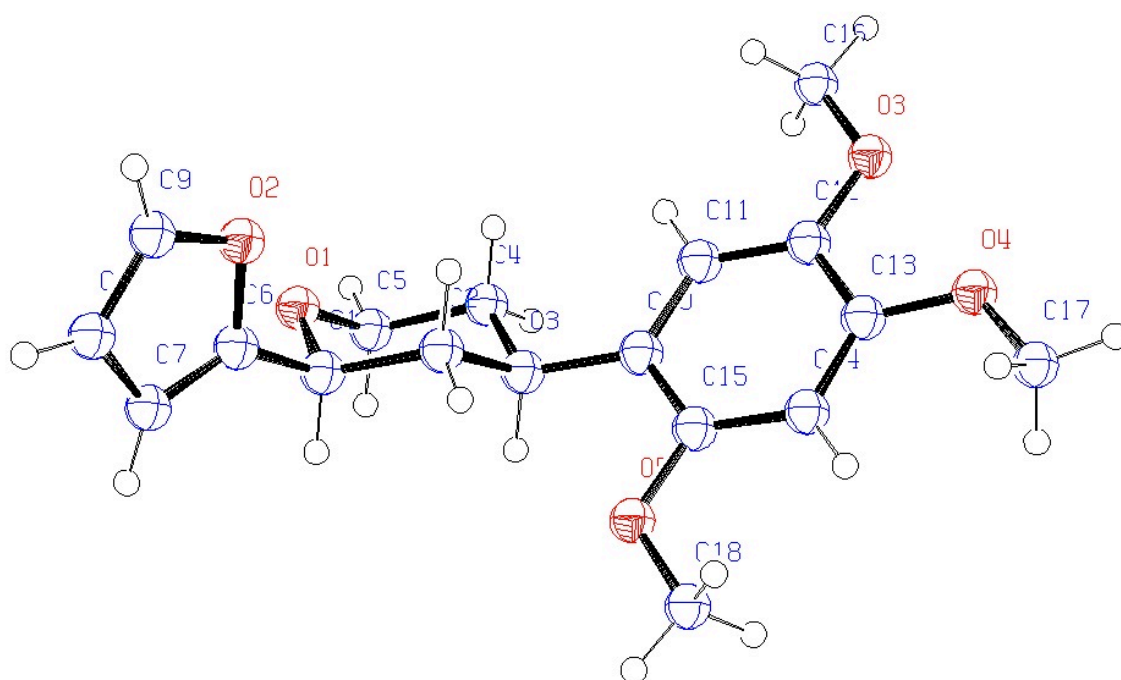
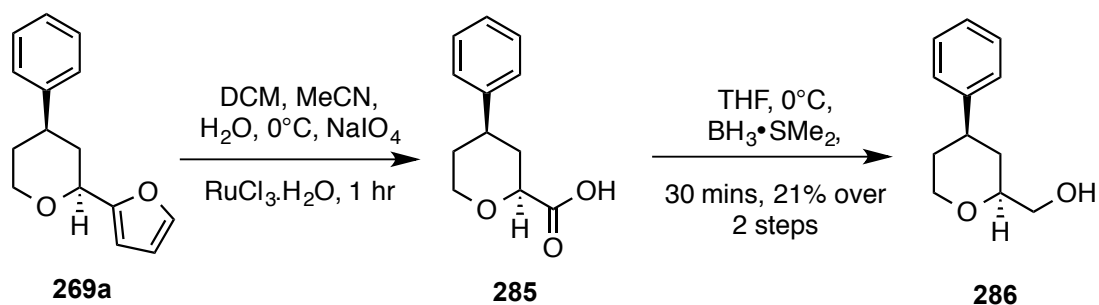

Figure 2.8: X-ray crystal structure of the trimethoxy 2,4-disubstituted tetrahydropyran **269g**.

This shows that the major diastereoisomer from the acid cyclisation of diols **269a-k** is the diequatorial compound. The tetrahydropyran ring is in the chair conformation and the furanyl substituent along with the substituted phenyl ring, are both located in the equatorial positions.

The aim of this investigation was to develop a methodology that could be used to synthesise 2,4-disubstituted tetrahydropyrans stereoselectively but could then be taken on further and used in further syntheses. In order to test this the furanyl group was oxidatively cleaved¹⁵⁹ (as seen in previous work by the group in the synthesis of compound **173** in Scheme 1.31). The resulting carboxylic acid **285** was then reduced to the corresponding terminal alcohol **286**.



Scheme 2.35: Conversion of the furanyl substituent to the corresponding terminal alcohol.

The furanyl group was oxidatively cleaved with sodium periodate and a ruthenium (III) chloride catalyst. The carboxylic acid from this reaction was obtained after one hour and was taken through the next step without purification. The removal of the carbonyl group proceeded in 30 minutes and, after purification by column chromatography, the pure alcohol **286** was obtained in a 21% over two steps.

The oxidative cleavage involves ruthenium (III) chloride with a co-oxidant of sodium periodate. This generates ruthenium (VIII) oxide, which catalyses the reaction. This is used alongside a ternary solvent system that is made up of acetonitrile, water and typically carbon tetrachloride.¹⁵⁸ This allows oxidative cleavage to the carboxylic acid in good yields and when there is a stereogenic centre at the α -position to the carbonyl group the reaction proceeds without epimerisation.¹⁵⁹ This was an important consideration for this reaction so that the stereoselectivity from the cyclisation was not lost.

Reduction of the carboxylic acid was achieved using borane. This was selected for use as the transformation would readily occur under mild conditions and without affecting the remainder of the compound.¹⁶⁰

This two-step conversion was completed without optimisation and therefore this reaction yield could very probably be increased; however it does show that the disubstituted tetrahydropyrans can be taken through further steps and this allows the methodology to be used in synthesis of more biologically active and pharmaceutically interesting compounds.

When developing this synthesis it was thought that the malonate addition product could also be used to synthesise the corresponding triols. These could then be cyclised and be used to synthesise 2,4,5-trisubstituted tetrahydropyrans. If successful, this would demonstrate double diastereoselectivity. The 2,4-disubstituted tetrahydropyran pathway was followed first to ascertain if the single diastereoselectivity would be achieved as imagined, before progressing to the more complex scenario.

2.4. Stereoselective Synthesis of 4-aryl-2-furyl-5-hydroxymethyl Tetrahydropyrans

The idea of synthesising 2,4,5-trisubstituted tetrahydropyrans came from the idea of utilising double diastereoselectivity. This would mean that a single, defined chiral centre would control the formation of two new chiral centres, rather than a single chiral centre as seen in the synthesis of 2,4-disubstituted tetrahydropyrans. The other advantage to this project was that it could be completed in a short space of time, as the synthetic pathway required branched from the pathway used for the disubstituted compounds after the successful synthesis of the keto-diester. These could be reduced, resulting in the corresponding triol that would then cyclise under acidic conditions to yield the 2,4,5-trisubstituted tetrahydropyrans.

If successful then it was theorised that the stereoselectivity would come about from two sources. The first, as seen in the 2,4-disubstituted tetrahydropyrans, would arise from the ability of the furanyl chiral centre to epimerise under acidic conditions and the reversibility of the cyclisation reaction under these conditions, meaning that the thermodynamic product could form over time, giving a greater ratio in favour of the more stable compound.

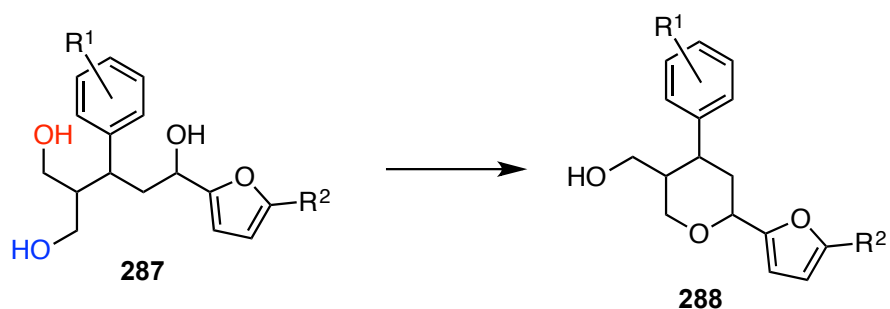

Scheme 2.36: Theorised formation of 2,4,5-trisubstituted tetrahydropyrans.

As shown in Scheme 2.36 there are two terminal hydroxyl groups in the triol compounds. Under acidic conditions the cyclisation mechanism is very similar to that of Scheme 2.33 with an additional hydroxymethyl substituent. However, when cyclised either of these two hydroxyl groups (either the one in red or the one in blue) can be the one that cyclises to produce the tetrahydropyran ring. Due to the reversibility of the cyclisation reaction it was hypothesised that over time there would be a shift to favour the hydroxyl group that places the remaining hydroxymethyl group, when in the tetrahydropyran product, in the equatorial position. This, coupled with the ability of the furanyl group to epimerise under the reaction conditions, would theoretically produce the triequatorial tetrahydropyran as the thermodynamically more stable product, and therefore this was hypothesised to be the major product of the reaction.

The keto-diester that was being used as the starting material was generally the same material that was used for the Krapcho decarboxylation in the previous synthesis. In some cases more material needed to be synthesised and this was easily achieved from the remaining chalcone material and use of the potassium

carbonate facilitated conjugate addition reaction described previously. All material was purified before being reduced.

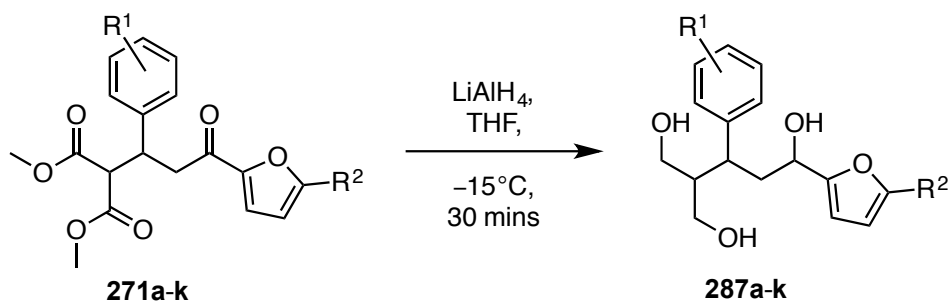

Scheme 2.37: Lithium aluminium hydride reduction of keto diesters (**271a-k**) to the corresponding triol (**287a-k**).

Entry	Compound	R ¹	R ²	Yield ^a	d.r.
1	287a	H	H	Crude	1.25 : 1
2	287b	4-Cl	H	47%	N/A
3	287c	4-OMe	H	33%	1.67 : 1
4	287d	4-CH ₃	H	27%	1.33 : 1
5	287e	3,4-OMe	H	15%	1 : 1
6	287f	4-Br	H	35%	1 : 1.25
7	287g	2,4,5-OMe	H	65%	2 : 1
8	287h	4-Br	Me	28%	1.67 : 1
9	287i	H	Me	35%	2 : 1
10	287j	4-CH ₃	Me	31%	1.67 : 1
11	287k	4-Cl	Me	37%	1.67 : 1

^a: Isolated yields after purification *via* column chromatography.

Compound **287g** was synthesised by Dr O'Brien.

Table 2.11: Triols synthesised during the route to achieve 2,4,5-trisubstituted tetrahydropyrans.

Reduction to the triols was achieved using lithium aluminium hydride, as described in the previous synthesis. The Fieser method¹⁶¹ was investigated as an appropriate work-up technique; however this showed no obvious advantage in yield or time over an aqueous work-up. Another alternative approach would be the use of Rochelle's salt (sodium potassium tartrate);¹⁶² however this can take up to twelve hours to complete and so was not investigated at this time.

There was a moment of serendipity during the triol synthesis. When left overnight the diastereomers of triol **287b** separated. One was a crystalline material, whilst the other remained as an oil. After a number of recrystallisations the diastereomers were fully separated and an X-ray crystal structure was obtained on the crystalline product to determine its stereochemistry. Through the process of elimination this gave the stereochemistry of the diastereomer that was an oil.

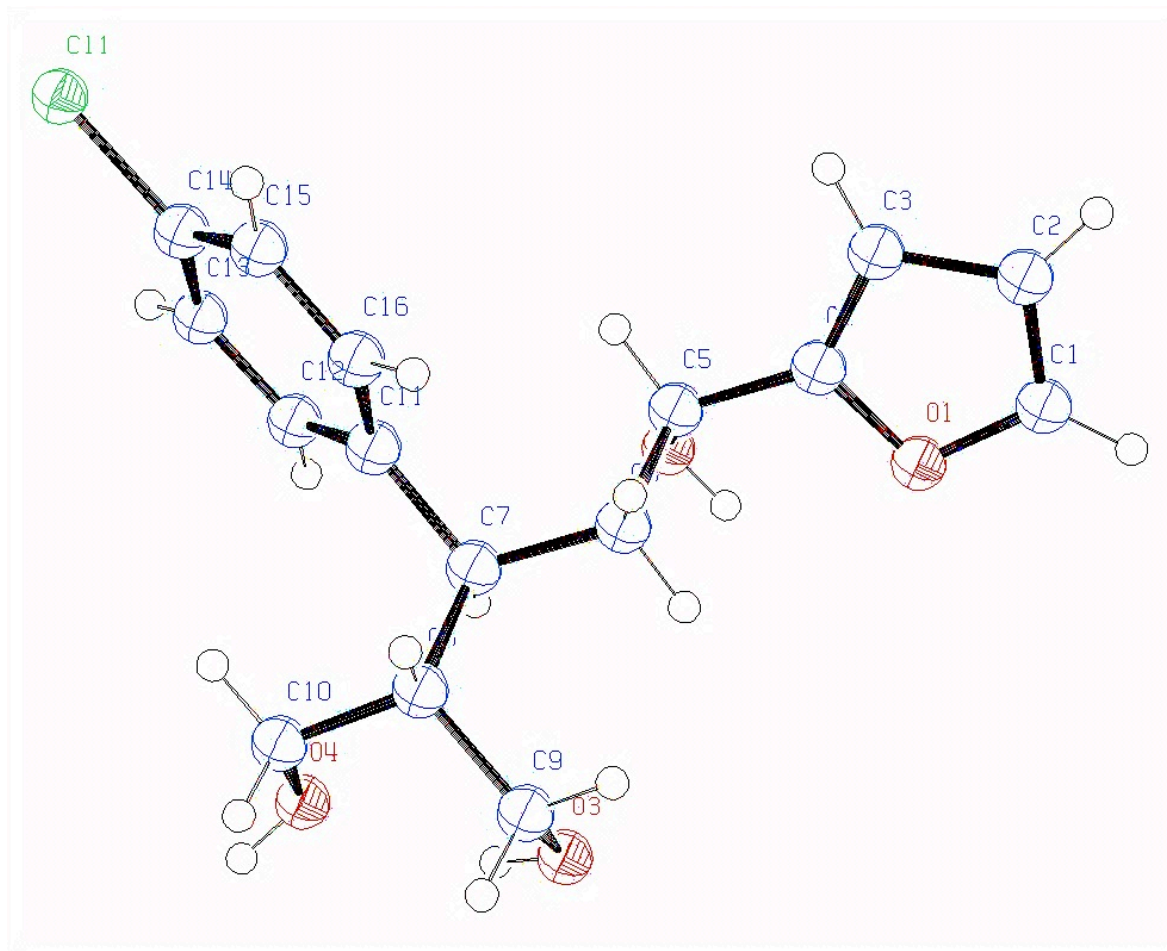
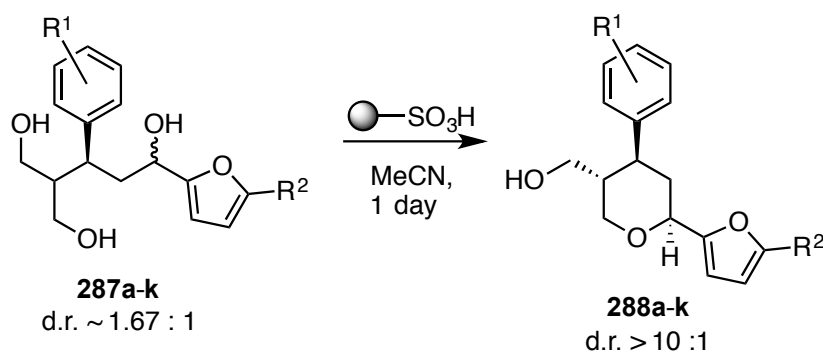

Figure 2.9: X-ray crystal structure of the crystalline *para*-chloro triol **287b**.

The final stage in the synthesis of the 2,4,5-trisubstituted tetrahydropyrans was to cyclise the triol compound under acidic conditions in order to establish the stereoselectivity of the reaction. Previously the acid cyclisation step had been completed using polymer-supported sulfonic acid in acetonitrile. Due to the effectiveness of this method it was applied to this cyclisation as well.



Scheme 2.38: Cyclisation of triols **287a-k** to yield the 2,4,5-trisubstituted tetrahydropyrans **288a-k**.

Entry	Compound	R ¹	R ²	d.r.	Yield ^a
1	288a	H	H	12:1	23%
2	288b	4-Cl	H	17:1:1:0	89%
3	288c	4-OMe	H	18:1	87%
4	288d	4-CH ₃	H	13:1	95%
5	288e	3,4-OMe	H	19:1	89%
6	288f	4-Br	H	10:1	86%
7	288g	2,4,5-OMe	H	20:1	96%
8	288h	4-Br	Me	12:1	63%
9	288i	H	Me	12:1	84%
10	288j	4-CH ₃	Me	13:1	75%
11	288k	4-Cl	Me	10:1	83%

^a: Isolated yields after purification *via* column chromatography. The yield for **288a** is over two steps.

Compound **288g** was synthesised by Dr O'Brien.

Table 2.12: 2,4,5-trisubstituted tetrahydropyrans synthesised and the diastereomeric ratios obtained. Note that for **288b** the ratios of all four diastereoisomers can be given. In the other cases only the major and minor ratios can accurately be given.

What needed to be examined was whether the timings of the reaction needed to be adjusted to allow time for the compound to epimerise. This could easily be achieved as the polymer-supported acid could easily be filtered off, thereby removing the acid source and allowing for $^1\text{H-NMR}$ analysis without affecting the material that was not part of the NMR sample.

The reaction mixture was analysed at various times: 15 minutes after addition of acid, 25 minutes after, 40 minutes after, 3 hours after and 2 days after. Even after 15 minutes there was no triol present in the reaction mixture; however the ratio of the two major diastereoisomers seen within the spectrum was relatively low (3:1). Over time the ratio of these two diastereoisomers increased to a ratio of 13:1 after 3 hours and then to 24:1 after two days. Due to this the cyclisation reactions were left under acidic conditions for one day to yield a highly enriched mixture in favour of one diastereoisomer.

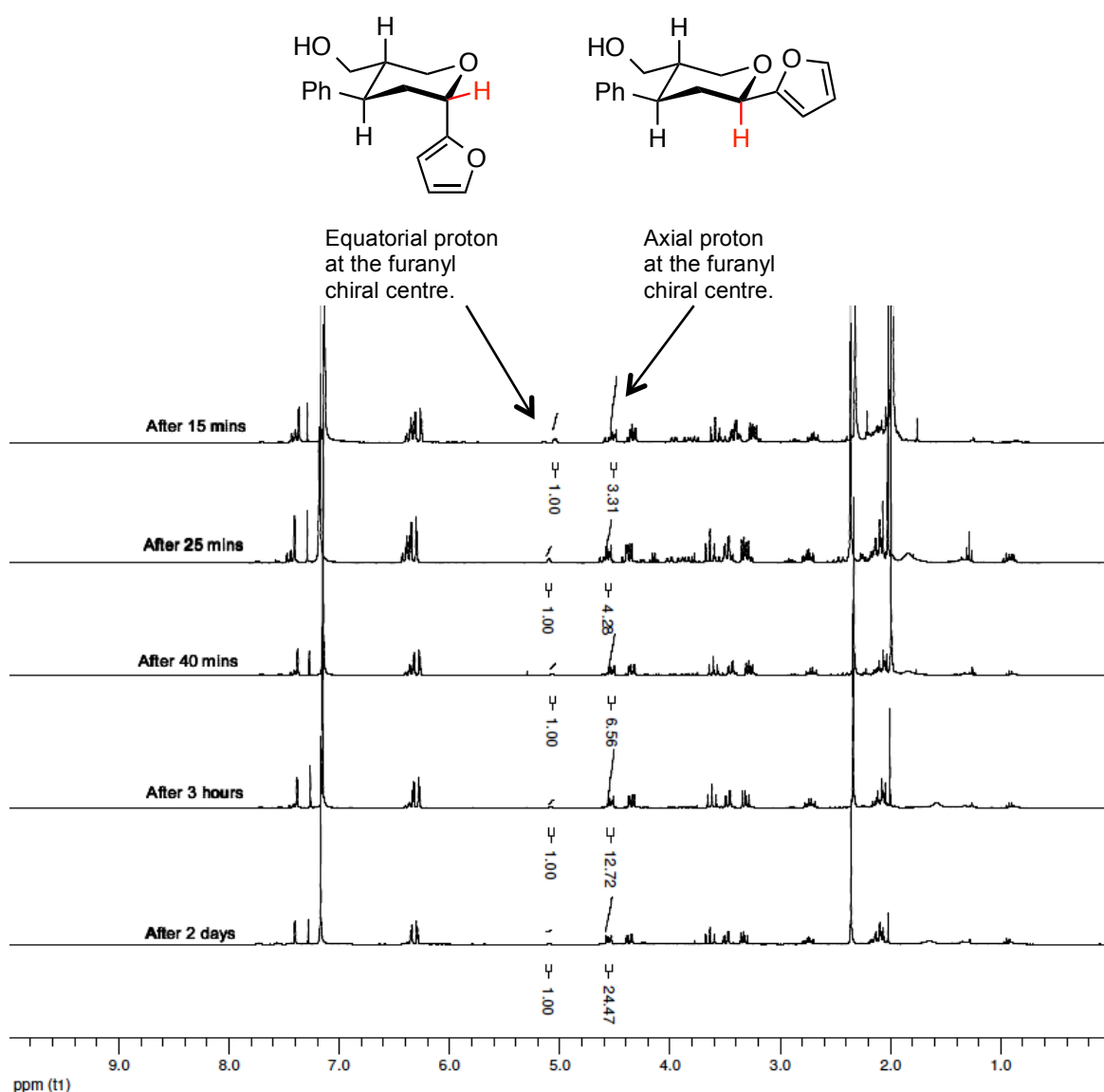

Figure 2.10: $^1\text{H-NMR}$ comparison for the cyclisation of triol **287a** over a period of two days.

In the NMR spectrum only two diastereoisomers can clearly be seen. This was surprising as there was a potential four diastereoisomers that could be formed from this reaction (as shown in Figure 2.11).

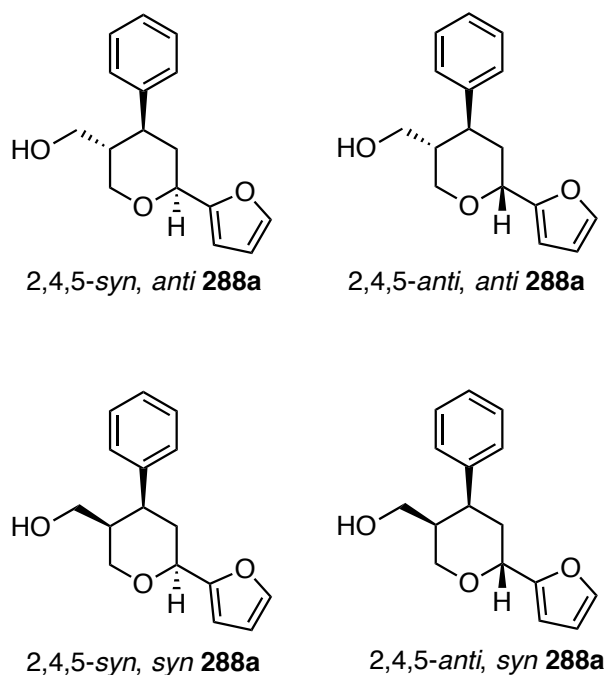

Figure 2.11: The four diastereoisomers of 2,4,5-trisubstituted tetrahydropyran **288a**.

In an attempt to determine the diastereoisomers present from the cyclisation reaction an effort was made to obtain sufficient quantities of the minor diastereoisomers for spectroscopic analysis.

A 2D-NOESY spectrum was obtained on **288d** in an attempt to determine the stereochemistry of the product. This showed peaks between the C-2 proton, the C-4 proton, the C-6 axial proton and one of the C-3 protons. Coupled with the J-values obtained this suggested that the major diastereoisomer was the triequatorial compound.

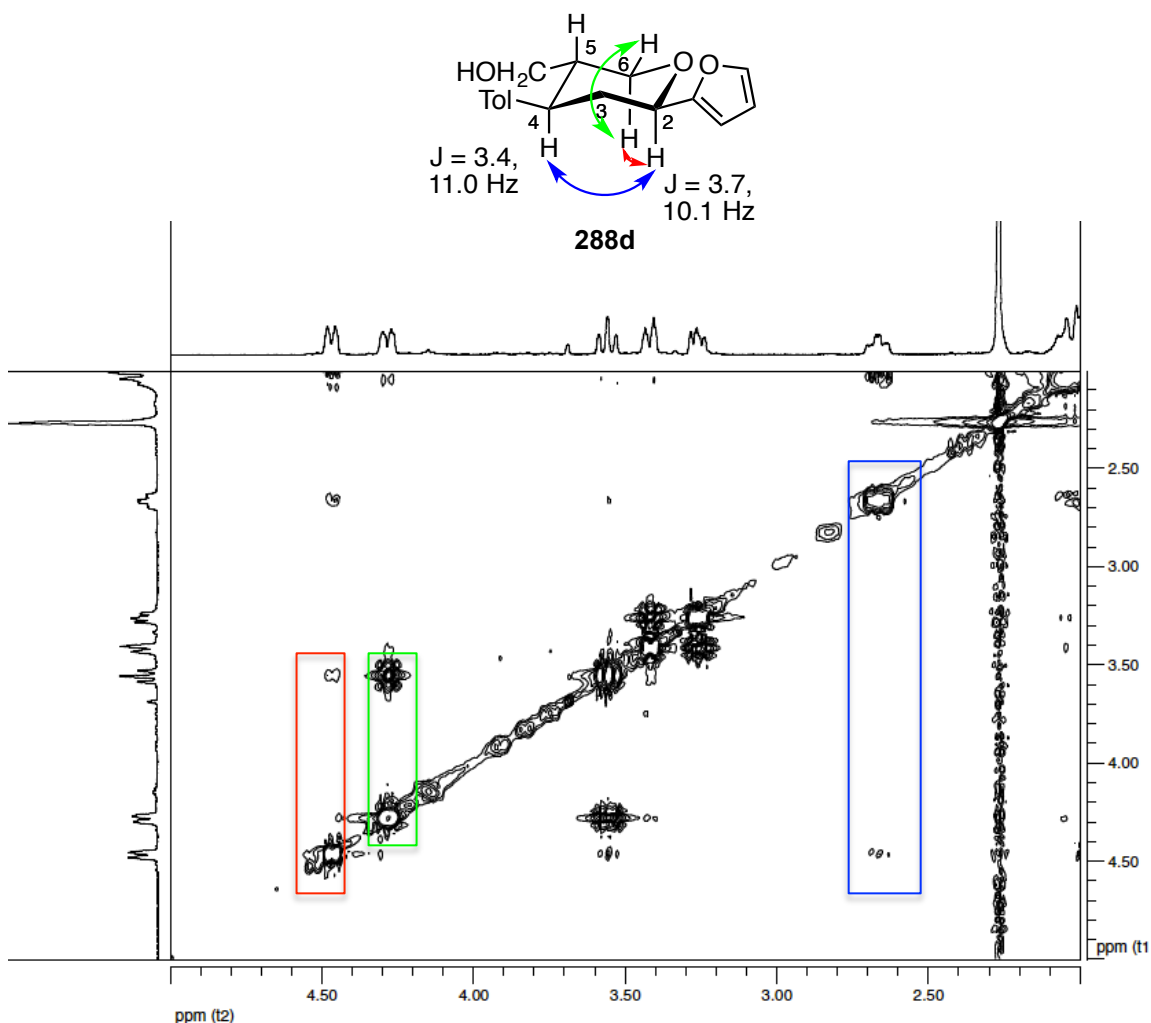
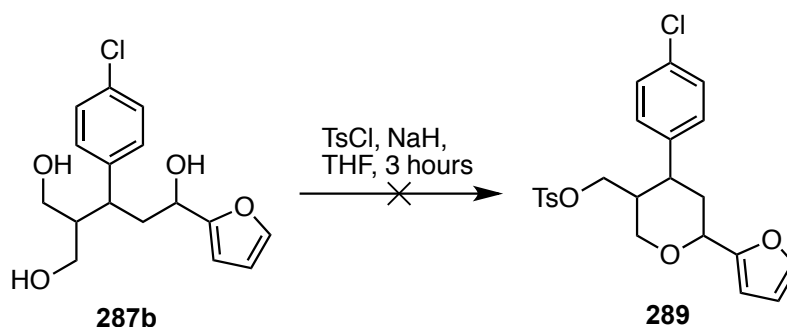

Figure 2.12: NOESY spectrum seen from the diastereomeric mixture produced from cyclisation of triol **287d**.

Although this information was extremely useful it did not provide information about the stereochemistry of the remaining three diastereoisomers. Obtaining these other three stereoisomers would allow for structural determination. Even obtaining some of the minor compounds would allow for greater structural determination by elimination. Previously, in the case of the 2,4-disubstituted tetrahydropyrans, this was achieved through the tosylation-cyclisation of the precursor followed by careful column chromatography in order to separate the diastereoisomers.

The base-promoted cyclisation was attempted using tosyl chloride and sodium hydride as had been achieved previously. This would theoretically cyclise the triol without allowing epimerisation and would also mean that the hydroxymethyl group would not be the terminal alcohol but would instead be a tosyl-protected alcohol. Obtaining the pure diastereoisomers *via* this method proved unsuccessful, probably due to the small scale the reaction was completed on.



Scheme 2.39: Attempted base cyclisation of **287b**.

The fortuitous separation of the two *para*-chloro triol (**287b**) diastereoisomers suggested an interesting strategy to access significant quantities of the minor cyclisation diastereoisomers. This would involve the mono *tert*-butyldiphenylsilyl (TBDPS) protection of one of the primary hydroxyl groups followed by the separation of the two stereoisomers formed. This would give four diastereoisomers that could then be cyclised under acidic conditions (**290a-d**). Two of these four diastereoisomers would give a mixture of two of the cyclised diastereoisomers whilst the other two would give a mixture of the remaining two cyclised diastereoisomers. This would be achieved as one of the hydroxyl groups would be locked by the TBDPS protecting group, therefore preventing it from taking part in the cyclisation. The acidic conditions would still allow the furanyl group to

epimerise but that would be the only epimerisation seen. Once these mixtures of diastereoisomers were obtained then NMR experiments could be conducted on each pair and the resulting spectra could be compared to the spectrum obtained when the cyclisation of triol **287b** was performed. Dr O'Brien carried out the synthesis for this work.

Both *para*-chloro triol diastereoisomers were individually dissolved in dichloromethane and to this was added the TBDPS-chloride and DMAP. From these reactions a mixture of both mono-protected compounds were obtained alongside a trace amount of the bis-protected compound. In no case was protection of the furanyl secondary alcohol seen. Repeated careful chromatography separated these two reaction mixtures into the four mono-protected diastereoisomers (**290a-d**). These were then each individually cyclised using the established acidic conditions.

The mixtures of **291a+b** and **291c+d** were both deprotected through the use of tetrabutylammonium fluoride (TBAF). This removed the TBDPS protecting group but did not affect the stereochemistry of the compounds meaning that all four diastereoisomers of the tetrahydropyran **288b** were obtained. The *syn,anti* and *anti,anti* **288b** compounds were those that could easily be seen in the original NMR spectrum when **287b** was cyclised under acidic conditions. From comparing the NMR spectra it was also possible to see that in the original NMR spectrum the *syn,syn* **288b** compound was also present; however none of the *anti,syn* compound was seen (see Figure 2.11).

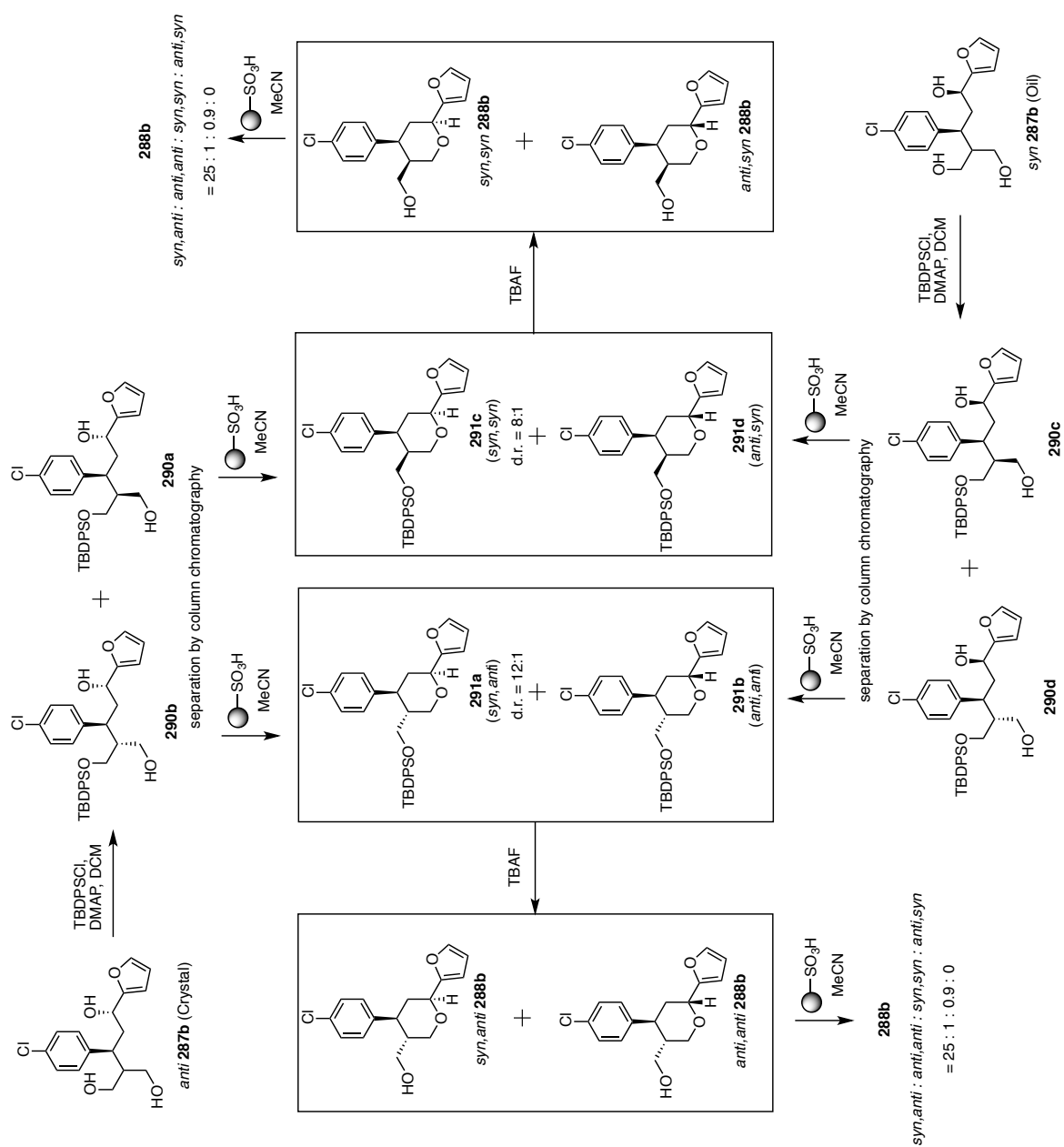

Scheme 2.40: A summary of how all *para*-chloro trisubstituted tetrahydropyran diastereoisomers were obtained.

The reasoning behind this is that when the TBDPS-diols **290a** and **290c** were cyclised under acidic conditions, the tetrahydropyrans that were produced (**291c+d**) were in a ratio of 8:1, where the major diastereoisomer was that which placed the phenyl group and the furanyl group in the equatorial position whilst the hydroxymethyl group was in the axial orientation. Due to this selectivity it stands to reason that the *anti,syn* configuration is not seen in the NMR spectrum when the reaction is conducted under acidic conditions with triol **287b**; assuming that the selectivity seen originally is the same as the selectivity seen when completing the reaction with the presence of the TBDPS-groups.

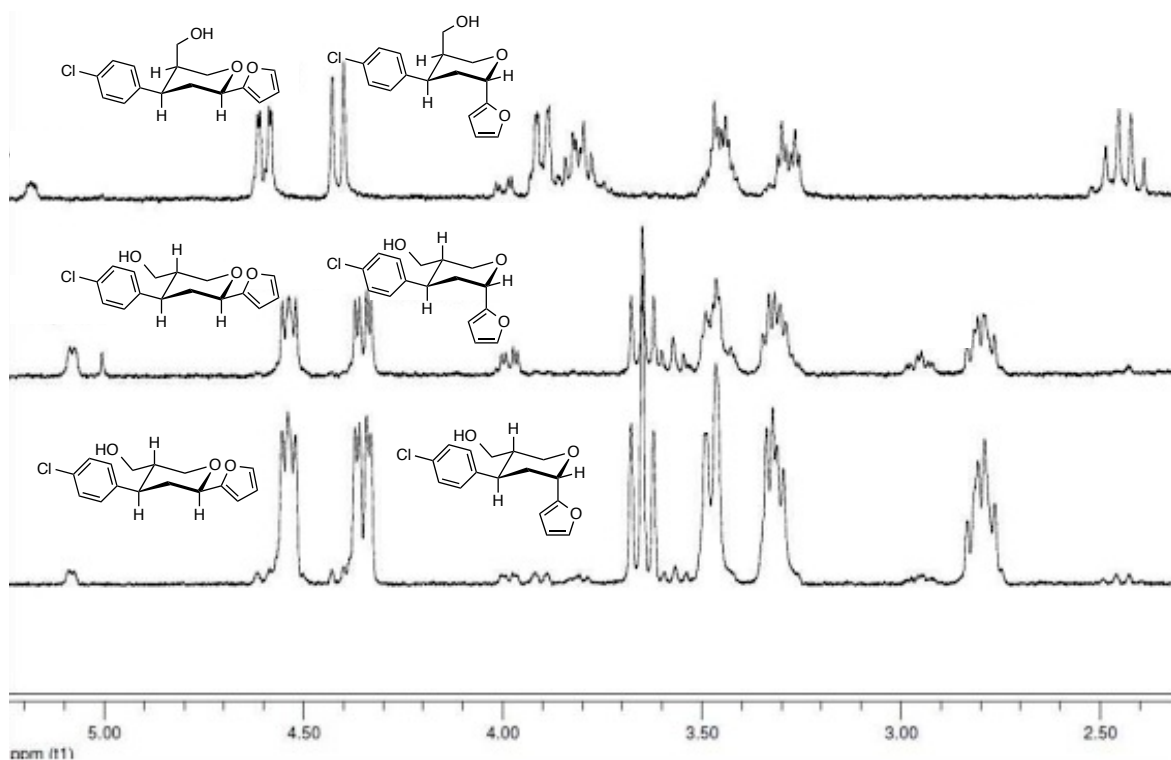

Figure 2.13: NMR overlay between 5.25 ppm and 2.25 ppm. Top – *syn,syn-288b* and *anti,syn-288b*, Middle – *syn,anti-288b* and *anti,anti-288b*. Bottom – Cyclisation of **287b** under standard acidic conditions.

The NMR spectra in Figure 2.13 show the mixtures obtained from the TBDPS-protection methodology and also the acid-catalysed cyclisation and epimerisation of the triol. This shows that more than two diastereoisomers are present in the final mixture.

If the *syn,syn 288b* and *anti,syn 288b* mixture is placed under the same acidic conditions as used in the cyclisation step then epimerisation is able to occur and this results in the mixture going to the same ratio as was initially seen favouring the *syn,anti 288b* compound as the major diastereoisomer. Likewise if the *syn,anti 288b* and *anti,anti 288b* mixture is placed under the same acidic conditions as

used in the cyclisation step then epimerisation also occurs. This increases the ratio in favour of the *syn,anti* **288b** compound and also shows a trace amount of *syn,syn* **288b** in the spectrum.

After this work it was possible to state with confidence the double diastereoselectivity of this reaction. Only three of the possible four diastereoisomers were seen once the reaction had gone to completion and been given time to epimerise. This can only confidently be stated with the *para*-chloro example though as none of the remaining triols were separated and taken through these steps.

Although NMR data gave a clear indication of which stereoisomer was favoured the aim was to unambiguously determine this and again the answer was to obtain an X-ray crystal structure. Unlike previously, none of the compounds had spontaneously yielded crystals, even after a period of time in the freezer at approximately -20°C . Due to this attention turned to the dimethoxy and trimethoxy compounds (**288e** and **288g** respectively). These had successfully given crystalline products in the 2,4-disubstituted tetrahydropyran series and it was hoped that this would also be the case in this series.

Over the course of several days a number of solvents were used in the hope that the slow evaporation of the solvent would orientate the molecules in a suitable manner for a crystalline product to form. Unfortunately no success was seen with the dimethoxy substituted compound **288e**; however a crystal was eventually

gained from the trimethoxy product **288g**. This was achieved through a number of repetitive slow evaporations of diethyl ether at room temperature.

Once the crystal had formed it was sent to the National Crystallography Service at the University of Southampton and an X-ray crystal structure obtained.

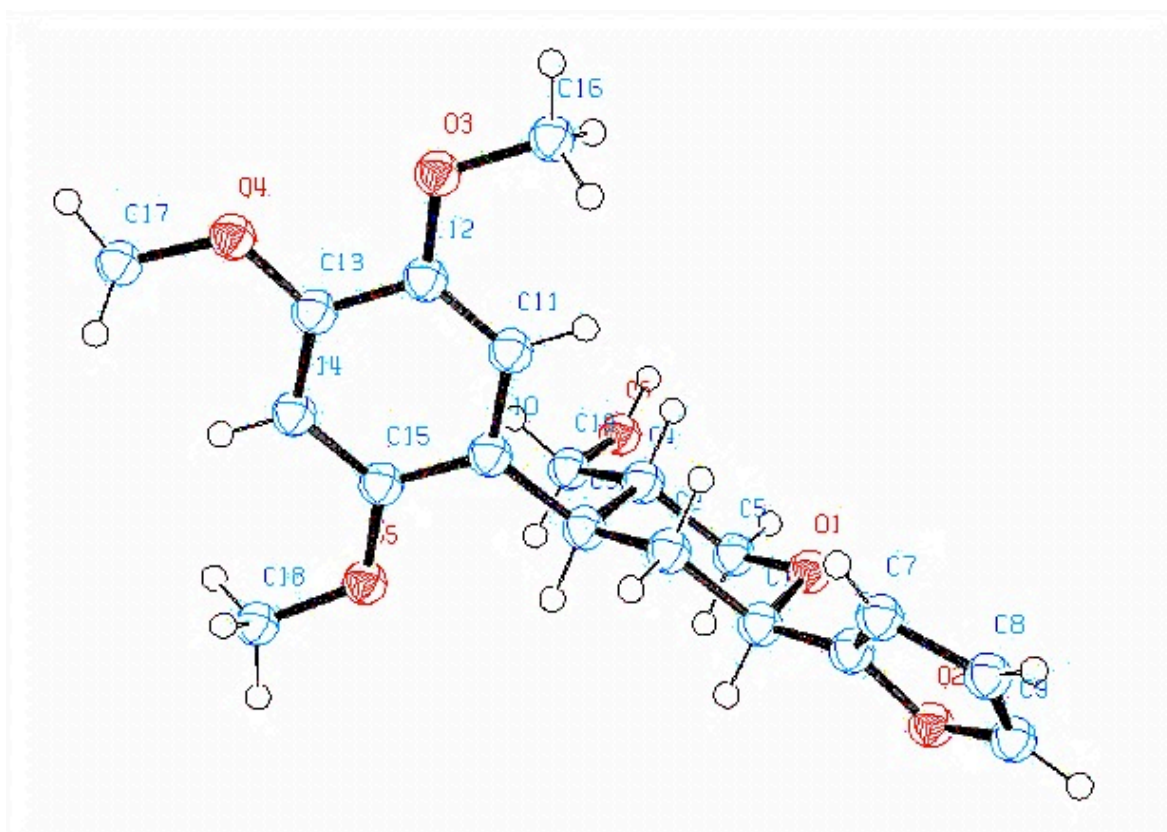
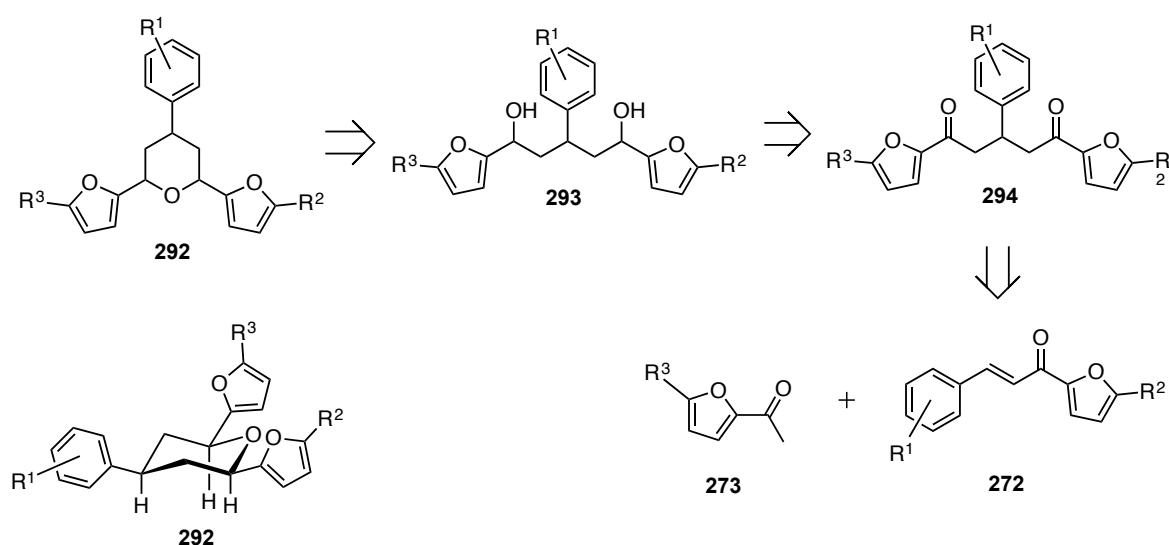

Figure 2.14: X-ray crystal structure of the trimethoxy trisubstituted tetrahydropyran **288g**.

After successfully exploring the synthesis of both 2,4-disubstituted and 2,4,5-trisubstituted tetrahydropyrans an alternative strategy for double diastereoselection presented itself. This was to create a 2,6-disubstituted tetrahydropyran where both the substituents were a furanyl or 5-methylfuranlyl group.

2.5. Synthesis of 4-aryl-2,6-difuranyl Tetrahydropyrans

As previously discussed the furanyl functional group is highly versatile and is able to undergo a plethora of transformations allowing the further development of the compound, and therefore proving synthetically useful in terms of facilitating the synthesis of natural products or other biologically active compounds. It is this versatility that led to the idea of using the methodology developed in the synthesis of 2,4- and 2,4,5-trisubstituted tetrahydropyrans and applying it to the synthesis of a 2,4,6-trisubstituted tetrahydropyran where both the 2- and the 6-substituent would be a furanyl group.



Scheme 2.41: Retrosynthetic analysis of 4-aryl-2,6-difuranyl tetrahydropyrans. The hypothetical triequatorial compound is depicted.

Not only would this be interesting due to the potential that the molecule would have in terms of use in future syntheses but as the cyclisation would again be occurring under acidic conditions then in theory high levels of stereoselectivity

would be seen based on the ability of the furanyl chiral centre to epimerise. This has already been seen in previous examples and the results suggested that the stereochemistry in this case would favour the triequatorial compound (**292**). This would be assumed anyway due to the increased stability when compounds are located in the equatorial position.

Synthesis of these compounds began with the chalcones (**272c**, **d** and **f**). These underwent an addition reaction with 2-acetylfuran (**274**). This introduced the second furanyl group and was completed under identical conditions as the chalcone synthesis (i.e. adding 5% aqueous sodium hydroxide solution to methanol and refluxing the reaction mixture).

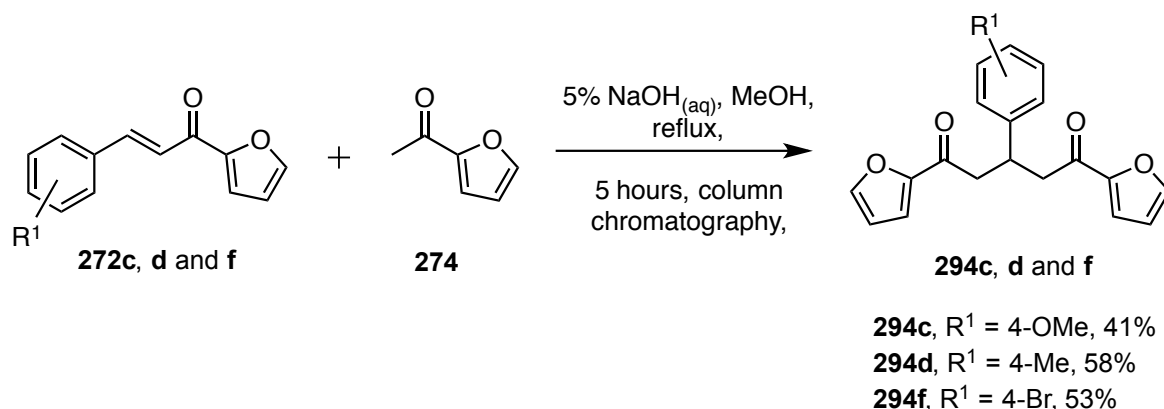

Scheme 2.42: Reaction between chalcones (**272c**, **d**, and **f**) and 2-acetylfuran (**274**) to synthesise the difuranyl diketones (**294c**, **d** and **f**).

As the chalcones had been synthesised on such scales previously there was no need to synthesise them again for this project; however as the reaction conditions are the same for this reaction as the aldol condensation reaction then it may have been possible to use double the number of equivalents of 2-acetylfuran (**274**) in

the initial reaction in order to synthesise the difuranyl-diketones (**294**). Despite not attempting the one-pot reaction, yields of the desired products were moderate and easily gave enough material in order to test the synthetic pathway.

Upon obtaining the difuranyl-diketones (**294**) the next step was to generate the 1,5-diol moiety. Sodium borohydride was chosen over lithium aluminum hydride, which was used in the previous syntheses. This meant that the work-up was substantially easier due to the absence of aluminium salts forming during the work-up procedure.

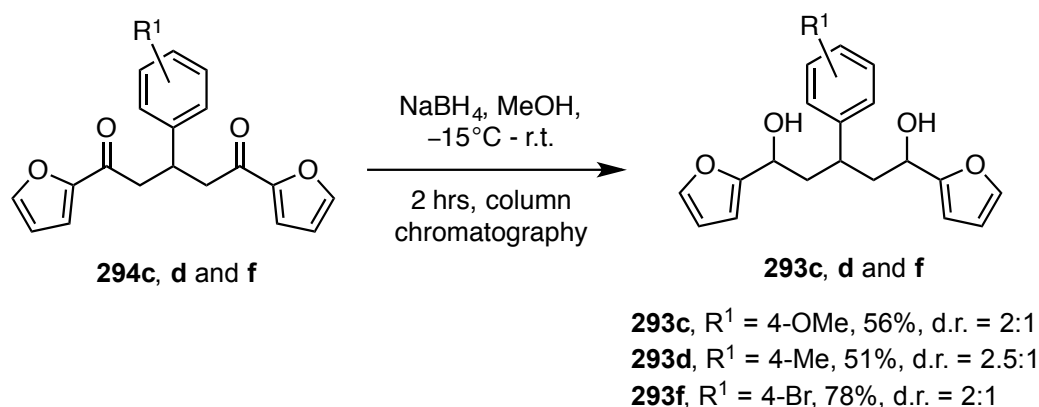

Scheme 2.43: Reduction of the difuranyl diketones to the corresponding diol.

The reduction went in moderate to high yields and after purification by column chromatography gave the desired 1,5-diols. All fractions containing any diol diastereoisomer were combined (as well as two fractions either way) to ensure that the stereoisomers were not being separated, as this would affect the conclusions drawn from the reaction. The ¹H-NMR spectra of these compounds only seemed to show two diastereoisomers when three would be expected. This

may be due to overlap of peaks, rather than only two diastereoisomers being produced.

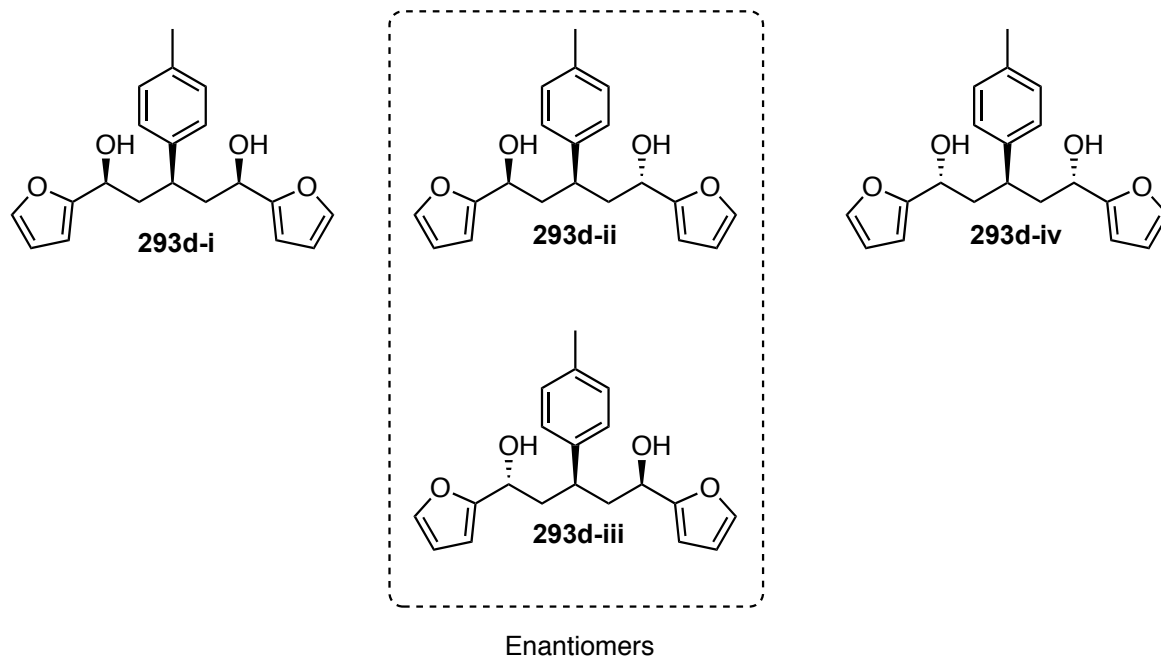
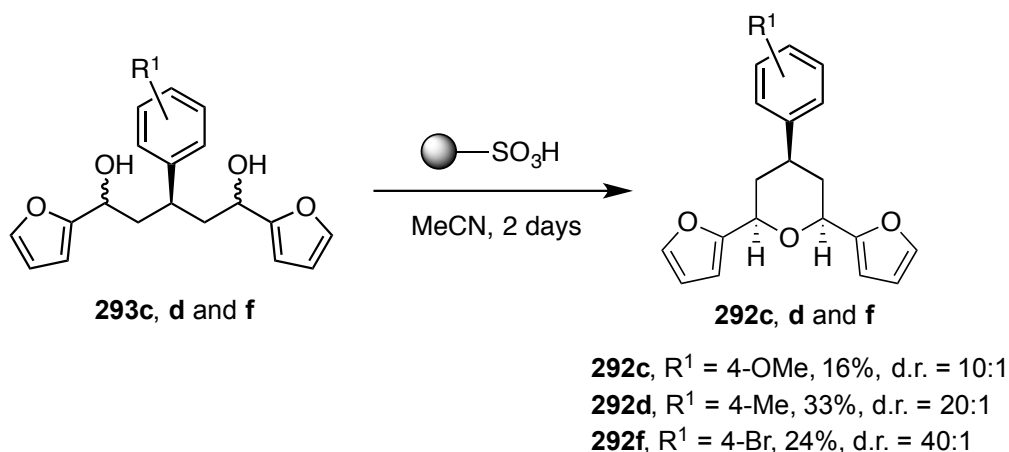

Figure 2.15: Difuranyl diol stereoisomers. **293d-ii** and **293d-iii** are enantiomers and therefore the $^1\text{H-NMR}$ should be the same in both cases. This means that there are three possible diastereoisomers that could be seen in the diol $^1\text{H-NMR}$ spectrum.

The previous projects had already optimised the cyclisation process using polymer-supported sulfonic acid and so this method was again used in the cyclisation of the difuranyl-diols (**293**). The acidic conditions would allow both of the furanyl groups to epimerise and over time to favour the more stable conformation. The hypothesis going into this experiment was that both furanyl groups and the aryl group would be in the equatorial positions due to the reversibility of the cyclisation step and the resulting epimerisation under these conditions.



Scheme 2.44: Cyclisation of difuranyl diols to the corresponding 4-aryl-2,6-difuranyl trisubstituted tetrahydropyran.

There was one main difference that was seen during the course of this reaction that had not been seen in the previous cases and this was that the solution became black in colour. This suggested some sort of decomposition or side reaction, which was confirmed upon analysis by TLC as several spots were observed. Once the reaction was filtered and purified by column chromatography the yields of the desired compound were low in all cases (10% - 26%).

This low yield was disappointing because although there seemed to be a mixture of diastereoisomers that favoured one in particular, it could not be stated that the reaction was stereoselective as questions arose about where the other material was and whether selective decomposition was being seen (i.e. one diastereoisomer would decompose before the other under these conditions).

TLC and ¹H-NMR was used to monitor this reaction over a period of six days to investigate what was happening. These showed that the desired product was

being formed, alongside an unknown impurity. $^1\text{H-NMR}$ analysis suggested that this impurity was an aldehyde. After one day the impurity began to decrease in intensity and the diastereomeric ratio of the tetrahydropyran product reached 5:1. After four days this ratio increased to 14:1, but evidence of decomposition was clearly seen in the reaction vessel.

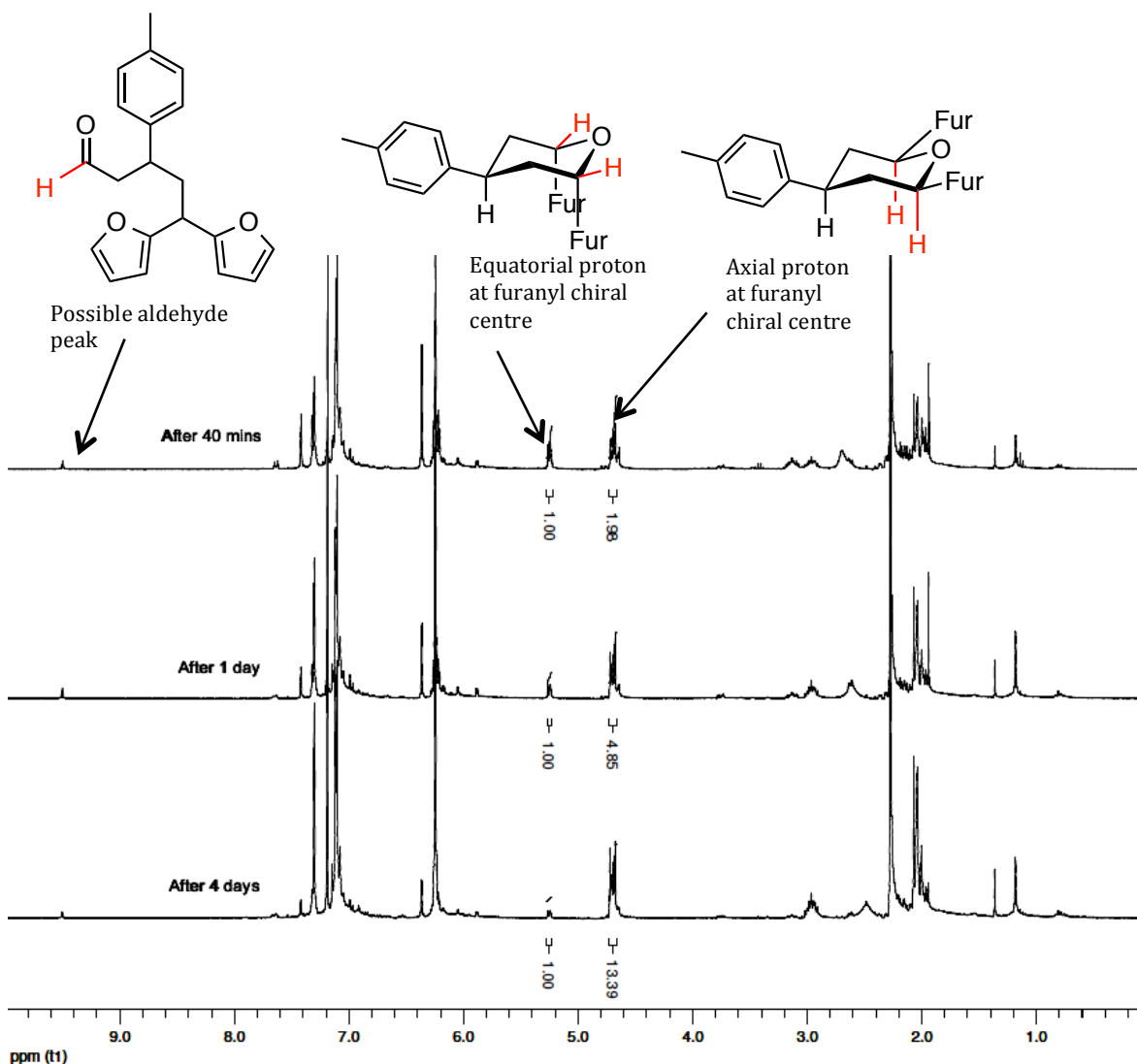

Figure 2.16: NMR analysis of the cyclisation reaction to yield the difuranyl tetrahydropyrans over the course of four days. The diastereomeric ratios of the two main diastereoisomers seen in the mixture are noted. Some peaks (e.g. peak above 9.0 ppm) correspond suspected aldehyde impurity. Fur = furanyl group.

As shown in Figure 2.16 not all the peaks present in the $^1\text{H-NMR}$ spectrum matched those of the desired product and the related diastereoisomers. Instead some peaks (e.g. the peak between 9.40 ppm and 9.60 ppm) correspond to the unknown impurity that formed during the course of this reaction. Peaks around this region usually represent an aldehyde proton, but in order to gain more information a number of NMR experiments were ran on this compound after it was isolated by careful column chromatography ($^1\text{H-NMR}$, $^{13}\text{C-NMR}$ and COSY experiments were conducted).

The $^1\text{H-NMR}$ spectrum showed the presence of the toluene group as well as the presence of the furanyl groups (integration of the peaks showed both furanyl groups were present), showing that the unknown compound was somewhat related to the desired product. After numerous discussions and analysis of the NMR spectra a putative structure was proposed as shown below in Figure 2.17. A possible mechanism that would explain the formation of **295** is shown in Scheme 2.45. The proposed mechanism involves the second furanyl group attacking the carbocation formed under acidic conditions to produce a favoured six-membered ring structure (**298**). This type of mechanism was not possible in previous projects. The reactions occur at the furanyl-2 position due to resonance providing increased stability and because it allows for the formation of a six-membered ring, which is favoured.

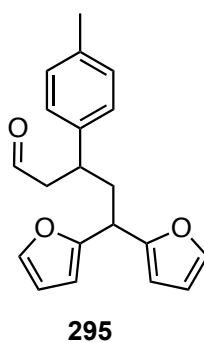
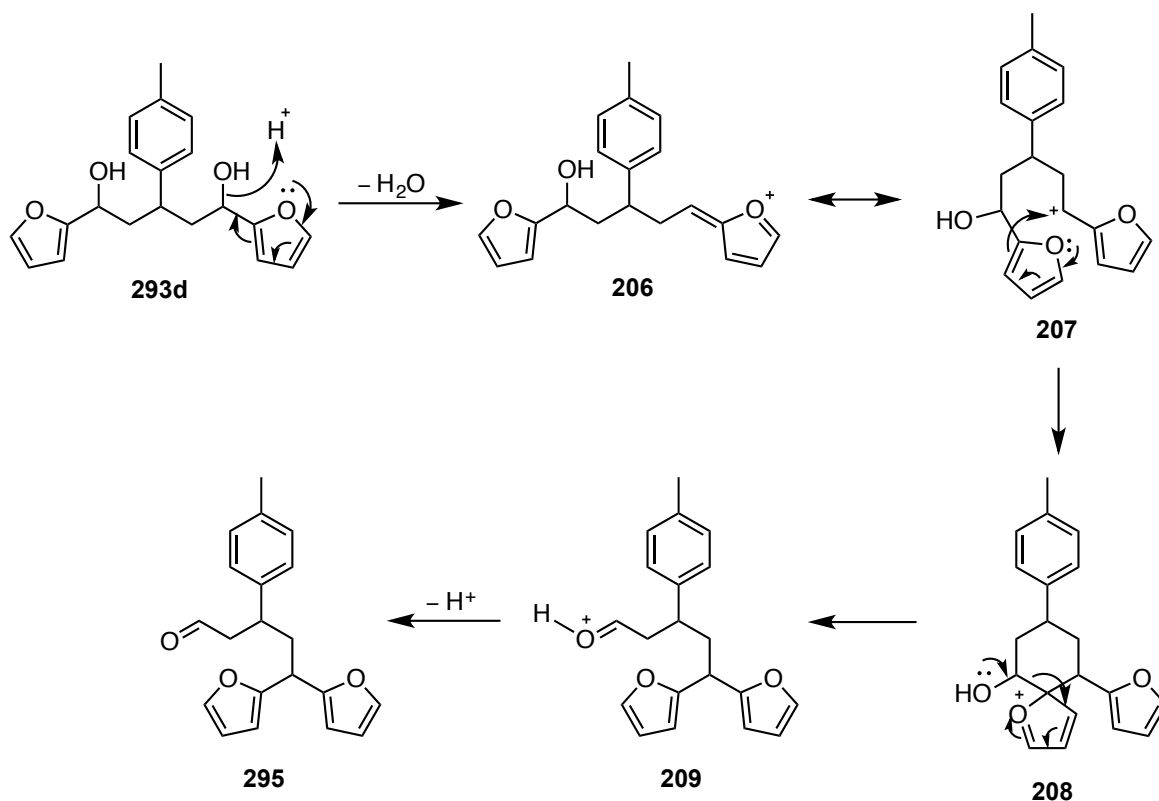

Figure 2.17: Putative structure of the by-product formed during the course of the cyclisation reaction.

Upon observation of the other NMR spectra obtained on this compound the putative structure seemed more likely. The ^{13}C -NMR showed a carbonyl group at 201.7 ppm. The aromatic and aliphatic regions of this NMR spectrum also matched the putative structure. This supported the aldehyde peak seen in the ^1H -NMR at 9.57 ppm.



Scheme 2.45: Theorised mechanism for the formation of the aldehyde by-product **295**.

It was thought that the aldehyde product and the desired tetrahydropyran product could be in equilibrium, with the tetrahydropyran being more thermodynamically favourable, meaning that over time the aldehyde could be used to produce the tetrahydropyran product (**292d**). In an effort to test this theory the isolated aldehyde **295** was subjected to identical reaction conditions as were used in the cyclisation step. After three days none of the tetrahydropyran product was seen; however the aldehyde had been consumed. The reaction mixture had also become black in colour over the course of these three days. The reaction mixture was passed through a silica plug, which was washed repeatedly with ethyl acetate. The reaction material remained at the top of the silica plug suggesting that it had decomposed over the three days. This explained where some of the material was

going during the course of the cyclisation reaction where the tetrahydropyran product was only being obtained in a 10% yield.

This idea of migration of a furanyl group is not unheard of in the literature and recently Li and coworkers reported on a 1,5-migration of a furanyl group;¹⁶³ however this was using a gold catalyst and the compound possessed a carbon-carbon triple bond, neither of which were present in our reaction. Despite this, the mechanism they propose is very similar to that which is proposed for the formation of **295**.

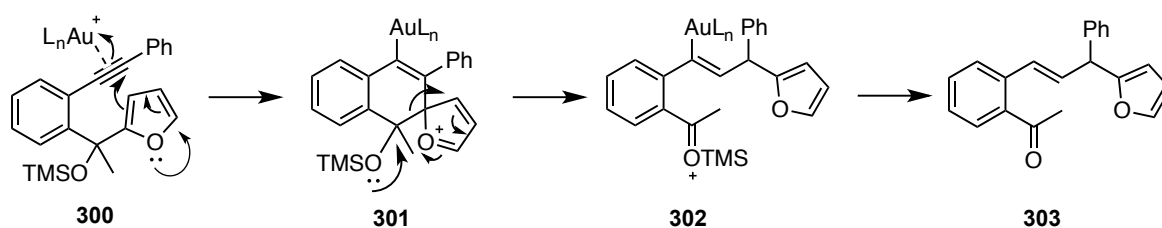

Scheme 2.46: Li's gold-catalysed furanyl migration mechanism. Adapted from reference 163.

This furanyl cation intermediate is also something that has been reported by Hashmi in 2012.¹⁶⁴ Again this movement of the furanyl group involved a gold catalyst and a carbon-carbon triple bond but the intermediate proposed is very similar to that proposed for the formation of aldehyde **295**. This migration of groups is something that is commonly seen in a 1,2-aryl migration *via* a phenonium ion.¹⁶⁵ Other aryl 1,5-migrations have been seen in the literature, however these do not proceed *via* the proposed mechanism to form **295**. Instead, these occur through a radical mechanism, as reported in 2000¹⁶⁶ and 2002¹⁶⁷ by Struder who used this method to prepare biaryls from silyl ethers.

As the acid cyclisation of diols **293c**, **d** and **f** were not proving fruitful the tosylation-cyclisation of **293c** was attempted. This was performed using conditions matching that of the tosylation-cyclisation seen in the synthesis of the 2,4-disubstituted tetrahydropyrans (i.e. sodium hydride with tosyl chloride).

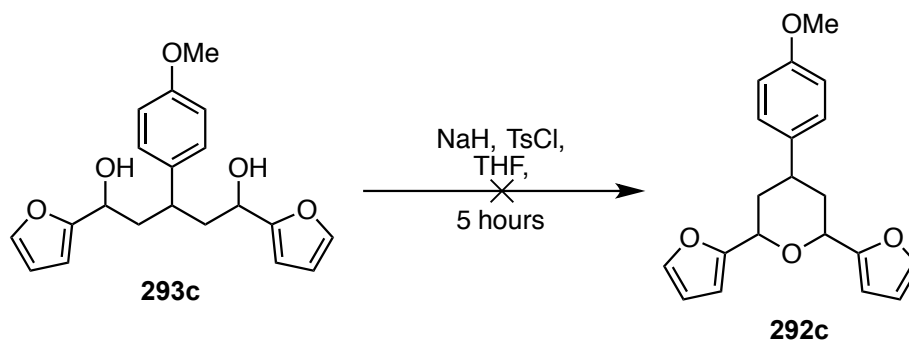

Scheme 2.47: Tosylation-cyclisation of difuranyl diol **293c**.

After the reaction was worked up the crude $^1\text{H-NMR}$ was not clear enough to make out the presence of all three diastereoisomers. Hence the reaction mixture was subjected to column chromatography in hopes making the $^1\text{H-NMR}$ spectrum clearer. This chromatography was able to separate the diastereoisomers somewhat; however clean separation of all three diastereoisomers was not achieved.

The diastereoisomers that could possibly form from this reaction are shown in Figure 2.18. The triequatorial compound, which was thought to be the major diastereoisomer showed only one axial hydrogen adjacent to the furanyl group (as would be expected) due to the mirror plane of symmetry (seen at 4.76 ppm in the $^1\text{H-NMR}$ spectrum). The peaks corresponding to this compound also only showed one set of CH_2 peaks in the $^1\text{H-NMR}$ spectrum at 2.14 – 2.01 ppm. The remaining

peaks in the spectrum were minor. A minor peak at 5.28 ppm seemed to be in the correct area for an equatorial proton on the tetrahydropyran ring; however it was not possible to fully characterise all diastereoisomers.

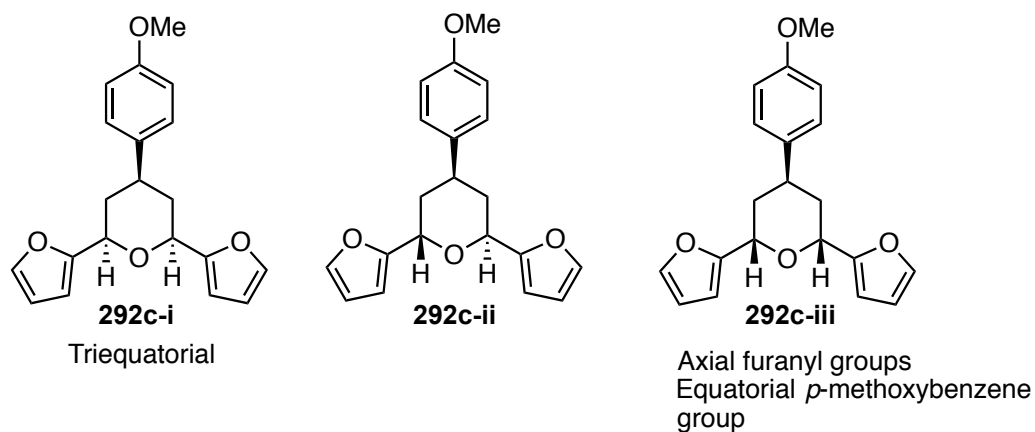

Figure 2.18: Possible diastereoisomers of tetrahydropyran compound **292c**.

In the enantiomeric stereoisomers the aryl chiral centre is in fact a pseudo-chiral centre. This is because, *via* flipping the molecule, the opposing structure maintains the same chirality. This is shown in Figure 2.19.

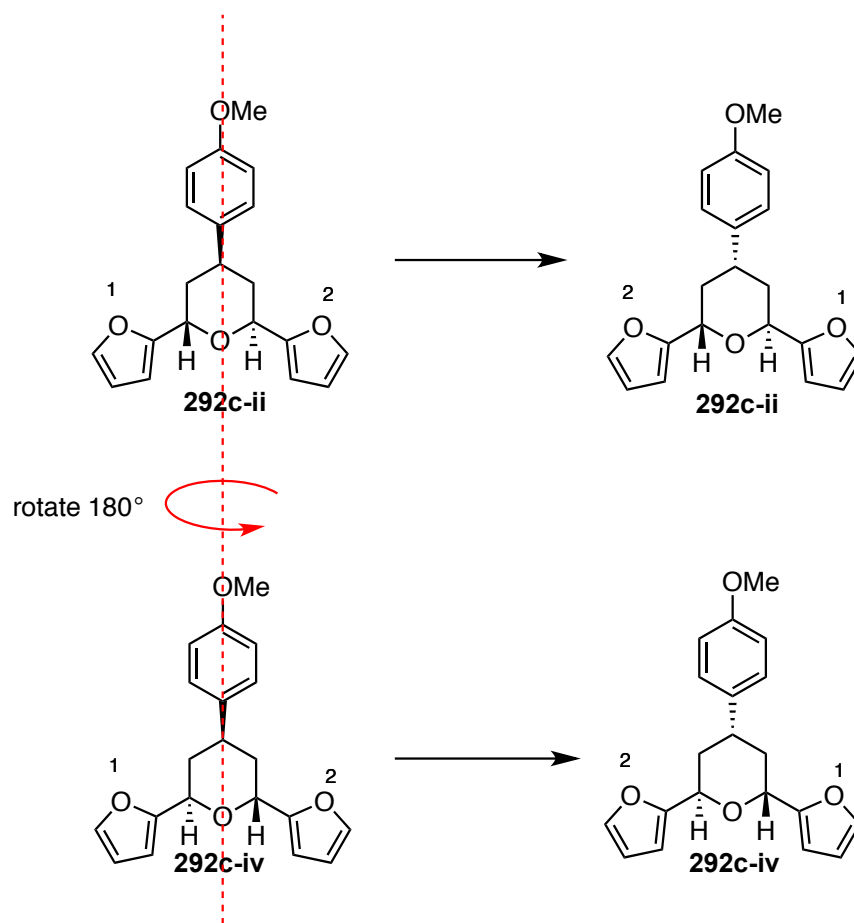

Figure 2.19: Pseudo-stereogenic centre that could be seen in **292c-ii** and **292c-iv**.

The diastereomeric mixture was stored in the freezer for when this project is continued. A number of questions arose from this project have yet to be answered, including:

- What is the effect of acid strength and solvent on the cyclisation?
- Can the cyclisation step occur without the side reaction being seen?
- Is the reaction stereoselective or is selective decomposition being seen?

This project was running alongside another and as that project seemed like it would be completed relatively quickly, attention was shifted to work on a continuous-flow synthesis system.

2.6. Continuous-Flow Chemistry System

2.6.1. An Introduction to Continuous-Flow Chemistry

Flow chemistry is an emerging technique as an alternative to the more traditional batch protocols that are used in synthetic chemistry. In flow chemistry, starting materials and/or reagents are continuously pumped through a relatively small reaction zone. This is different to batch chemistry where all the reagents are added to the flask at the start of the reaction and where the relative reaction zone is much larger.¹⁶⁸

Although traditional batch processes are still widely used and are perfectly suitable for an array of synthetic processes, there are a number of advantages that are seen through the use of a continuous-flow system. One of the biggest advantages in the use of a continuous-flow system is the exceptional heat exchange efficiency. This suppresses the build up of heat within the reaction (and so prevents the formation of hot spots). This is true even in the case of rapid and highly exothermic reactions.¹⁶⁹ This is achieved due to the high surface-area-to-volume ratio within the flow reactor and this means that any transfer of heat is far more efficient than is seen in a batch process. The temperature and pressure of the solvent and the reagents can also be manipulated in a far safer manner than in a traditional batch process. The temperature solvents experience can safely exceed the atmospheric norms within a continuous flow system through pressurising the system. This can safely be done, using a back-pressure regulator, due to the small volume of the reactor.¹⁷⁰ The back-pressure regulator is placed downstream of the heated

section. This blocks any flow that does not exceed the pressure setting on the regulator. This means that if the pump used can pump against that pressure then a continuous flowing stream, kept above a set pressure, is obtained and keeps the superheated solvent in the liquid phase.

Typically, an increase in the temperature increases the rate of reaction and the ability to greatly increase the temperature and pressure beyond the standard boiling point at atmospheric pressure theoretically should greatly increase the rate of reaction; however, the pump being used must be able to pump against the pressure formed without any damage being seen to the tubes and any connecting joints.

The reaction within the flow reactor only occurs in a relatively small reaction zone. This means that only a small quantity of material is being processed at any given time and this offers an enhanced safety profile, especially with the use of explosive or hazardous reagents/intermediates. Scale up of a reaction does not affect this small reaction zone as the reaction is scaled up over time (i.e. the pumping time is increased) rather than through a scale up of dimensions (as is seen in a batch process). This also means that issues are not seen of a scale-variant nature in terms of reaction parameters. This is something that was seen in batch with the hydrogenation of alkynes described in section 2.1. Reaction time in that case was vitally important as a reaction time of greater than two minutes began to exhibit signs of over-hydrogenation. Upon scale up, two minutes was not enough time for all of the reaction to have gone to completion and yet some of the material was beginning to be over-hydrogenated.

This was possibly due to the change in surface-area-to-volume ratio. The change in surface-area-to-volume ratio affects the rate at which hydrogen can pass from the gaseous phase, through the interfacial surface, to the liquid phase to take part in the reaction. This is something that could be addressed through the use of a continuous flow system as it allows fine control of the reaction time and also gives a high surface-area-to-volume ratio.

Although there are many advantages to the use of a continuous flow system there are also a number of limitations to the methodology. The key limitation seen with this technology is that reactions that are performed through the use of continuous flow need to be completely converted in the reaction zone. This is controlled by the flow rates and also by the path-length, as these affect the residence time. It is also important that the product formed during the course of the reaction does not precipitate in the solvent being used. This is because the precipitate can cause a blockage within the tubing, either preventing the continuous flow or causing the system to leak due to build up of pressure.¹⁶⁸ Precipitation can be circumvented through the use of an alternative solvent or through adjustments to the concentrations used in the reaction. However, this may impact negatively upon the reaction chemistry itself.

Any bubbles that are in the tubes or any biphasic mixtures that have been insufficiently mixed can also cause issues in the flow process and this is because they prevent the effective mixing of the streams and can result in an incomplete reaction. Reactor fouling and cross contamination can also be an issue in some systems if lines are not cleaned out upon completion of the reaction.¹⁷¹

All the above listed limitations are based on the equipment that is used for the continuous flow process; however, there is a limitation to using continuous flow itself. This is that some enantioselective reactions require an extended reaction time in order to achieve efficient asymmetric induction. The use of a continuous flow system does not easily allow for this.¹⁷⁰

Flow chemistry has been applied to a number of reactions that are traditionally performed using batch protocols that produce kinetically unstable intermediates during the course of the reaction. One of these is the Swern oxidation.

The Swern oxidation is one of the most commonly used methods in order to convert an alcohol to a carbonyl compound. Yoshida and co-workers reported on this Moffatt-Swern oxidation in a continuous flow system in 2005.¹⁷² Typically this reaction is conducted at cryogenic temperatures (-50°C and below).

The first step of the Moffatt-Swern type oxidation is activation of the DMSO (**304**). Yoshida achieved this through the use of trifluoroacetic anhydride (TFAA) (**305**). This generates an intermediate cation **306** that is stable below -30°C (hence the use of cryogenic temperatures); however the activation of DMSO can lead to a side product forming through a Pummerer rearrangement (**309**). The low temperatures also aid in minimising this side reaction.

The cationic intermediate **306** can then react with the desired alcohol to obtain a second intermediate that can be treated with base in order to obtain the desired carbonyl compound (the base that is commonly used is triethylamine). Treatment

of the second intermediate with a base can also result in another Pummerer rearrangement and this again results in an undesired side product (**312**). The undesired side product from the first Pummerer rearrangement (**309**) is also able to react with the alcohol used in the reaction and generate another undesired compound.

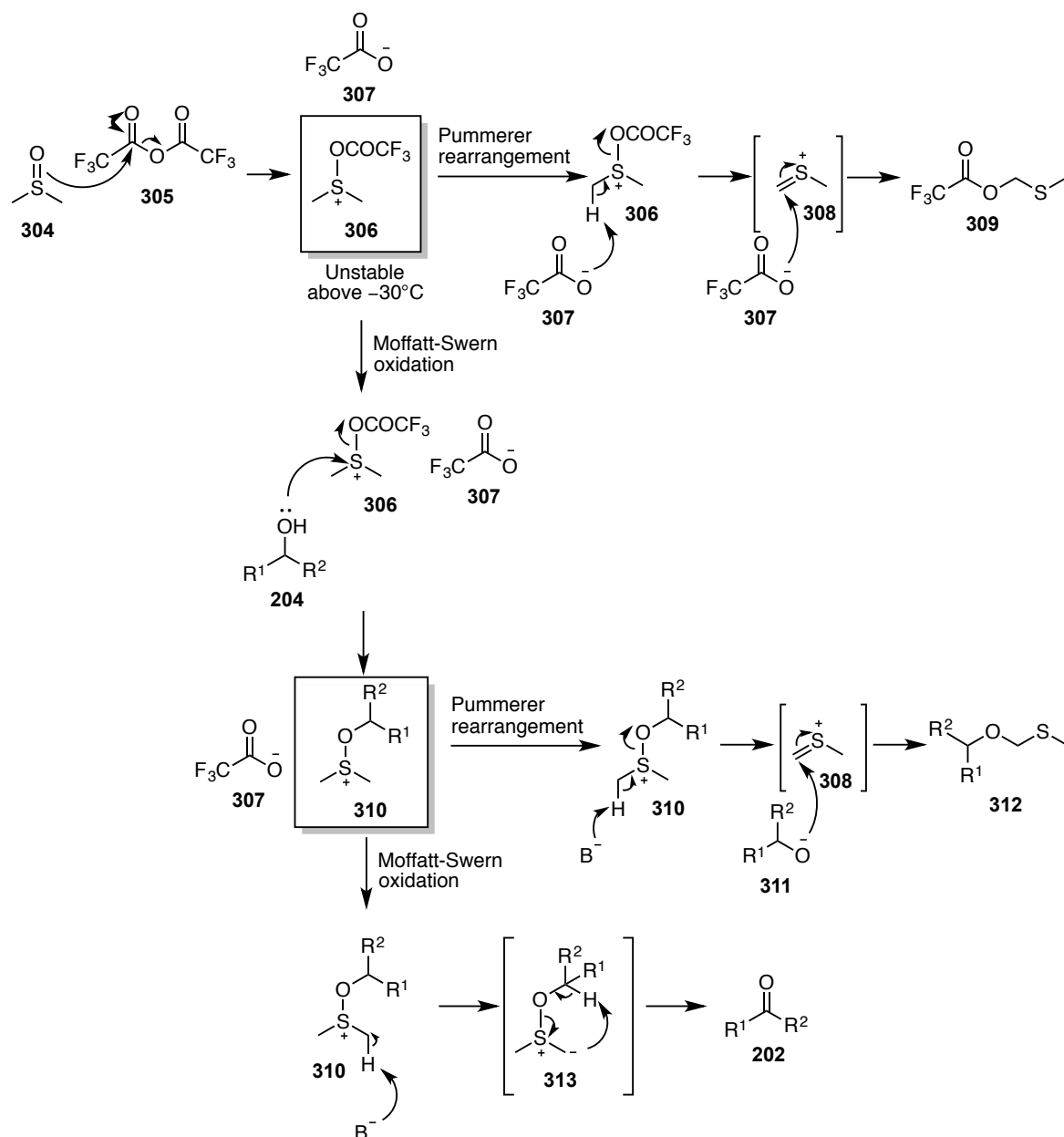

Scheme 2.48: Moffatt-Swern oxidation.

Although this reaction requires cryogenic temperatures in batch processes a substantial quantity of both impurities from the reaction are formed. Yoshida completed this reaction with a number of alcohols using continuous flow technology. This was done at -20°C , 0°C and 20°C . All three of these temperatures are above the temperature for the long-term stability of intermediate **306**. In each case the yield of the desired carbonyl compound far exceeded the yield of either of the two impurities and the yield of the desired product was far greater than was seen when using a traditional batch approach. This is because the flow-rate and path-length used in the flow reaction can be completely controlled. Therefore the intermediate can very swiftly be generated and reacted, minimising the time allowed for any unwanted side reactions and enhancing the yield of the desired product. This speed is noted in the fact that Yoshida refers to this aspect of flow chemistry as “flash chemistry”.

Flow chemistry is not only advantageous when reactive intermediates are generated but can be used with gases in order to increase the safety of the reaction. The use of gaseous reagents in reactions can often be dangerous due to the high pressures required. These gases are also very mobile and, should they be released into the air, can disperse very speedily. Reactions like this also tend to require the use of specialised, expensive equipment. These effects are intensified upon any scale up of the procedure. One way to counter this is through the use of continuous flow techniques using gas-liquid reactors. This is because they use a small volume reactor in order to minimise the volume of pressurised gas being used. This minimises the kinetic energy (and the volume of gas released) should the vessel rupture or the system leak.

One such reactor was developed by Ley and co-workers and was reported in 2015.¹⁷³ This made use of Teflon AF-2400, an amorphous co-polymer that is made up of fluoroethylene and perfluorodioxolane. This co-polymer is permeable to a number of gases; however, it remains impermeable to non-fluorinated solvents and a number of corrosives.

The reaction vessel was developed, keeping in mind the need for control over the pressure of the gas being used in the reaction. This was achieved by housing the reagent stream in the tube of Teflon AF-2400 and surrounding this with a larger diameter PTFE tube filled with the reactive gas. The tubing was separated at both entry and exit to the reaction vessel through the use of Swagelok T pieces in order to allow the precise control of the pressure and flow rate, within the reaction vessel, of both the reagent stream and the gaseous stream.

The paper reports on numerous examples of the successful use of this reaction vessel showcasing both its durability and variability. One such reaction that was tested was the Wacker oxidation using gaseous oxygen at 8-bar pressure.

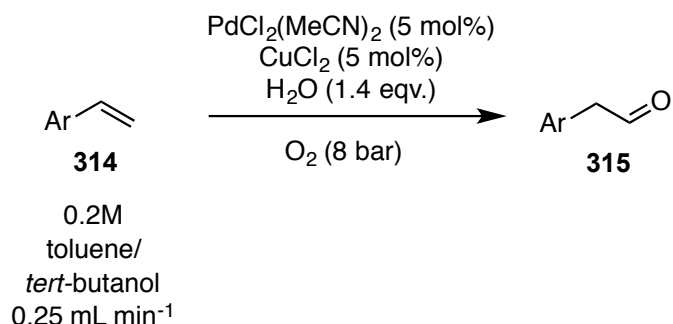

Scheme 2.49: Wacker oxidation completed in a continuous-flow system.

2.6.2. Developing a Continuous-Flow System for Liquid-Liquid Extraction

The premise that began this project was based on gravity-based liquid-liquid extraction, one of the most commonly used batch protocols for both work-up and purification. It is achieved using inexpensive reagents and apparatus. The idea of incorporating this into a continuous-flow system would provide a cost-effective purification stage that is continually replenished. This is advantageous compared to commonly used supported-reagents or scavengers as these get depleted over time.

Strategies to achieve liquid-liquid extraction in continuous-flow already exist using the selective wetting of materials in order to generate membranes. These are impermeable to aqueous solutions but permeable to organic solutions, thereby affording an easy separation (one such material is expanded, porous PTFE). One of the drawbacks to this method is that if the flow rates differ too much, or the combination of the flow rates is either too high or too low then inefficient separation of the phases can be seen.¹⁷⁴ Another drawback to this is that the pressure differential across the membrane needs to be controlled so as not to damage the physically weak structure.

An alternative to this technique is to adapt the batch protocol of gravity-based separations in a way that enables their use in a continuous flow system. The idea behind this is that the organic stream is mixed with an aqueous stream that is used to quench the reaction and/or extract any aqueous-soluble by-products. After being thoroughly mixed the biphasic mixture enters a separation chamber. Here

the mixture will settle out with the denser phase being at the bottom of the chamber and able to leave from there. The less dense phase is closer to the top and can be pumped out from there. By controlling the pump rate, the position of interface of these two phases can be managed but this requires the strict monitoring of that position, to ensure that the phases cannot enter the wrong outlets.

The notion behind the system developed for this project is that the position of interface is tracked through the use of a 'computer-vision' system that monitors the position of a float that sits at the liquid-liquid interface. This float was made up of a mixture of plastics. It was formed using a 210 mg piece of a the green plunger from a Norm-Ject 1 mL PP/PE disposable syringe, along with a 67 mg piece of a green Keck clip (made of polyacetal). The material from the plunger is less dense than water and the material from the Keck clip is more dense than dichloromethane. When fused together these sit at the interface position between an aqueous solution and dichloromethane. As the computer 'vision-system' monitors the position of this float it feeds information back in order to affect the speed of the pump that is removing aqueous material from the separation chamber. The upper and lower bounds can be set prior to beginning a run using the flow system and this allows the computer to be told what parameters that the float needs to be kept between. The separation chamber in this apparatus was the barrel of a 6 mL disposable syringe and the ideal point was marked as midway. If the float is above the upper bound (meaning that there is more dichloromethane than aqueous solution) then the aqueous outflow is reduced to 0 mL min⁻¹; at the ideal point then the aqueous outflow is around 1 mL min⁻¹ and as the lower bound

is approached (meaning that there is more aqueous solution than dichloromethane) the pump speed can increase up to a maximum speed of 9.9 mL min^{-1} depending on the severity of the situation.

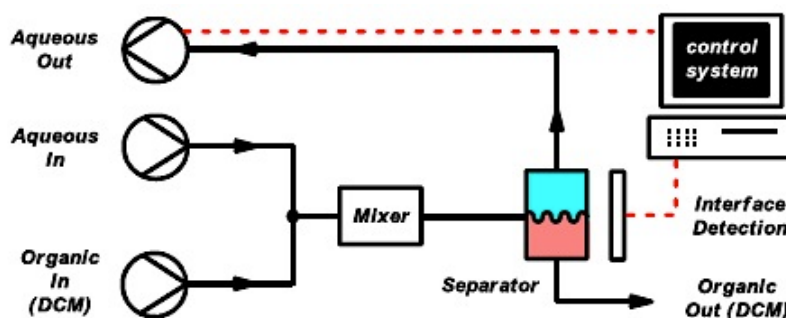

Figure 2.20: General schematic for the gravity-based liquid-liquid separator in continuous-flow.

Taken with permission from reference 175.

The use of this continuous flow system meant that any reaction performed needed to meet a number of parameters:

- The reagents and products formed from this reaction must be soluble in dichloromethane. Dichloromethane was chosen as the solvent because it is non-flammable and the system contained improvised, electronic circuits that could spark.
- During the course of the reaction no precipitate should form, nor should any gels.
- The aqueous phase must fully extract any reagents that had been present in excess as well as any side products formed during the course of the reaction.

- The reaction needed to progress to completion at room temperature as the necessary equipment (e.g. back-pressure regulator) for high temperature reactions was not available at the time.

Reactions that were considered for this system were tested and optimised in micro-scale batch reactions and were followed by TLC every minute for ten minutes. The results from this were then analysed and if the reaction had gone to completion then the quench/extraction process was tested and after this the organic material was concentrated under reduced pressure and then analysed by $^1\text{H-NMR}$ to determine the success of the extraction. If the reaction successfully passed through these two stages then there was a possibility of using it in the continuous flow system.

2.6.3. Testing Reactions for their Suitability for the Continuous-Flow System

Reactions that went to completion under these micro-scale batch conditions were only characterised by $^1\text{H-NMR}$. Any reaction that was successful and used in the continuous-flow system would then be fully characterised.

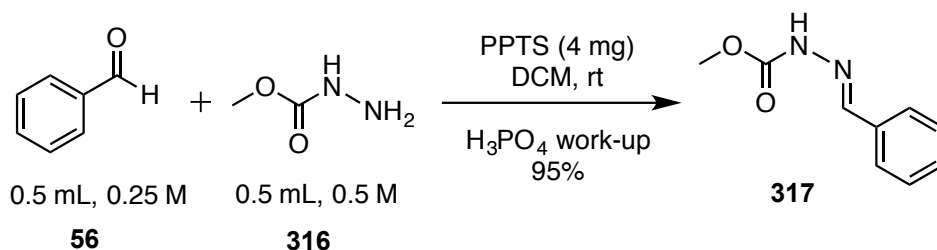

Scheme 2.50: Flow chemistry test reaction between benzaldehyde (**56**) and methyl carbazate (**316**).

The first reaction tested for its suitability was the reaction between aldehydes and methyl carbazate (**316**). This would make use of excess carbazate to react with the aldehyde. The carbazate compound was basic (the pK_a of similar compounds is around 13 with phenyl hydrazinecarboxylate possessing a pK_a of 13.6).¹⁷⁶ Because of this it was thought that the excess carbazate would be extracted through the use of aqueous acid. This would protonate the carbazate and the resulting salt would then be water-soluble and enter the aqueous phase. It was thought that the product resulting from this reaction would not be extracted as it would be less basic (due to the loss of the terminal amine) and any protonation would be less rapid than with the starting material.

The aldehyde used for the test reaction was benzaldehyde (**56**). 0.5 mL of a 0.25 M benzaldehyde solution was mixed with 0.5 mL of a 0.5 M methyl carbazate solution and this was monitored every minute by TLC for twenty minutes. Unfortunately the reaction did not go to completion in this time frame. A paper published in 2008 included this reaction in their synthetic pathway and they used an acid catalyst in this reaction.¹⁷⁷ In an effort to replicate this, the reaction was repeated but using 12.5 mg of pyridinium *para*-toluenesulfonate (PPTS), a weak acid catalyst. This reaction successfully went to completion in two minutes but began to form a precipitate after five minutes. This was an issue as precipitation could cause clogging of the tubing. The precipitate that formed did not readily dissolve in a variety of solvents and so this issue could not be achieved through dilution or a solvent mixture being used.

In an effort to prevent precipitation the mass of the acid catalyst used was reduced to 2 mg. This reaction took four minutes to go to completion but no precipitate formed even after standing for 20 minutes. It is possible that the precipitate that was forming was the protonated carbazate but no spectroscopic data was obtained on this compound.

Due to this success the work-up procedure was tested on the reaction mixture. The work-up was completed using 2.5 mL of 1 M phosphoric acid. The biphasic mixture was vigorously shaken for 30 seconds and then the organic phase was concentrated under reduced pressure and analysed. This showed that the reaction was successful and the extraction was also successful as only the desired product was present in the $^1\text{H-NMR}$ spectrum. The isolated yield of this reaction was 92%.

In an attempt to speed up the reaction further another reaction was set up using the same volumes and concentrations of benzaldehyde and methyl carbazate but using 4 mg of PPTS. It was hoped that this quantity of PPTS would be enough to increase the rate of reaction but not so much that issues of precipitation were seen. The reaction went to completion in 2 minutes and again no precipitate was seen even after 20 minutes of standing. The reaction was worked up using 1.5 mL of 1 M phosphoric acid and again this proved successful in extracting the excess reagent. This gave a 95% isolated yield.

The 2008 paper by He and Lam discussed the synthesis of these compounds in a reaction scheme they had developed towards the synthesis of 3-substituted and 3,3-disubstituted 1,2-dialkyl-pyrazolidine-3,5-diones. The synthesis of these

compounds were completed using solid supports and microwave reactors and the reason for their synthesis was their proven antimicrobial activity.¹⁷⁷ The development of a continuous-flow synthesis of the carbazate imine, incorporating an inline liquid-liquid extraction, might enable a complete multistep flow synthesis of these interesting compounds to be realised.

The hydrazone carbamates formed in the reaction between aldehydes and methyl carbazate do not only have a use as precursors for further reactions but phenolic hydrazone carbamates have been shown to possess an inhibitory effect on MIF tautomerase.¹⁷⁸

In a similar field, the reaction of amines and isocyanates was examined using benzylamine and 2-chlorophenylisocyanate.¹⁷⁹ In this situation the amine would be in excess and, due to the basicity of these compounds, it was thought that extraction using aqueous acid would be successful. As with the previous test, it was theorised that the product would be less basic than the amine due to the loss of the free amine group.

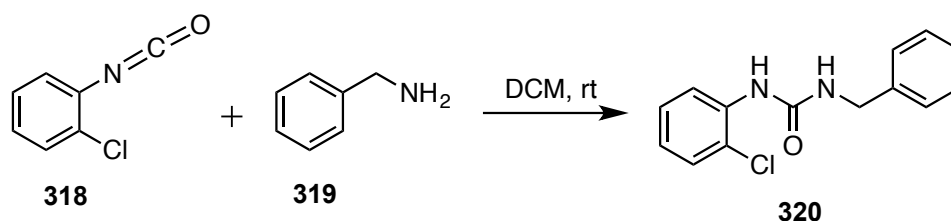

Scheme 2.51: Flow chemistry test reaction between 2-chlorophenyl isocyanate (**318**) and benzylamine (**319**).

The reaction was first set up using 1 mL of a 1 M solution of benzylamine (**319**) and 1 mL of a 0.5 M solution of 2-chlorophenyl isocyanate (**318**). The reaction was monitored every minute by TLC for 3 minutes. Analysis would have gone on for the full 10 minutes but after three minutes a large quantity of precipitate was seen in the reaction vessel. TLC analysis showed that the reaction had gone to completion in 1 minute. The reaction caused some initial boiling of the solvent due to its exothermic nature.

In an attempt to prevent the formation of the precipitate the reaction was set up identical to the previous one but an extra 1 mL of dichloromethane was added to dilute the reaction mixture. The reaction went to completion in 2 minutes this time but a precipitate began to form after 5 minutes and by 7 minutes was at the same stage as the previous test.

Various solvents were tested to dissolve the precipitate and the one that succeeded was butanol. As butanol is not miscible with water there was the potential to use that in the flow system if needed. However, when the reagent solutions were made up with butanol and the two solutions added together, no reaction was seen by TLC.

In an attempt to encourage the reaction to proceed, but to also keep any precipitate from forming, the reaction was run using a 3:1 mixture of dichloromethane and butanol. This showed progress of the reaction but full consumption of the starting material was not seen after twenty minutes; however no precipitate formed. Butanol seemed to be a good solvent to dissolve the

precipitate but not a suitable solvent for the reaction, possible due to hydrogen-bonding between the reagents and the solvent preventing the reaction from taking place.

In an effort to overcome this various other solvents were tested. Toluene, acetone, ethyl methyl ketone, diethyl ether and diethyl carbonate were all used; however in all five cases a precipitate formed meaning that under these conditions the reaction was not suitable for use in the continuous-flow system.

Rather than proceed with the successful reaction between aldehydes and methyl carbazate (**316**) this reaction was placed on hold for now. The reason for this was that the work up involved the use of phosphoric acid and there was concern that this would corrode the pump being used to remove the aqueous solution. Due to this concern various reactions were investigated that would use a basic work-up solution.

The first concept tested was to perform a Pinacol coupling in continuous flow. This could be achieved using benzaldehyde along with titanium tetrachloride and zinc, to generate the low-valent titanium II species. The concern with this reaction was how to extract the metal reagents. Rather than attempt the reaction followed by a quench/extraction step, a solution of titanium tetrachloride and zinc in dichloromethane and tetrahydrofuran (THF) was made up and the extraction techniques were tested solely on this.

The first extraction technique attempted was the use of ethylenediamine tetraacetic acid disodium salt (EDTA·2Na). The aim was to produce a 2 M solution of this in water, however due to a solubility issue this was not achieved. Because of this a 0.5 M solution of EDTA·2Na in water was attempted but again this did not fully dissolve; however a 0.5 M solution of EDTA·2Na in 2 M sodium hydroxide solution was successfully made. 1 mL of this solution was added to 1 mL of the TiCl₄/Zn solution to test the quench/extraction step but a precipitate formed meaning that this method wasn't suitable for use in the flow system.

Rochelle's salt (sodium potassium tartrate) is a common metal-chelating agent and so it seemed plausible to make use of this during the work-up procedure. A 2 M solution of this in water was made up and then 1 mL of the Rochelle's salt quench solution was added to 1 mL of the TiCl₄/Zn solution. No precipitate formed but the solution did become a very thick gel. Attempts to dilute this were made with the aim of reducing the viscosity of the gel; however these efforts were unsuccessful and the reaction was left for the time being.

Previously work had been completed using a similar continuous flow system on the protection of aldehydes with 1,3-propanedithiol.¹⁸⁰

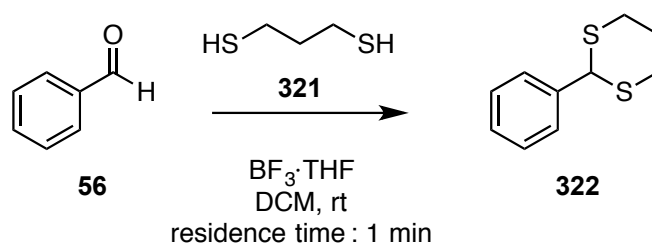

Scheme 2.52: Ley and co-workers continuous-flow reaction between aldehydes and 1,3-propanedithiol (**321**).

One possibility was to extend this to the use of 1,2-ethanedithiol. This reaction was completed under the same conditions as those reported in Ley and co-workers 2012 paper. Thiols can be extracted from the organic phase through the use of aqueous hydroxide solution and this was the method of extraction utilised by Ley.

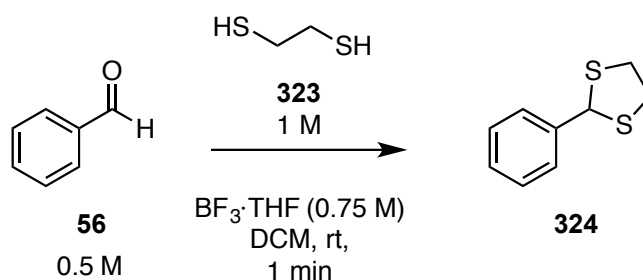

Scheme 2.53: Flow chemistry test reaction between benzaldehyde (**56**) and 1,2-ethanedithiol (**323**).

0.5 mL of a 0.5 M solution of benzaldehyde was mixed with 0.5 mL of a 1 M solution of 1,2-ethanedithiol and 0.75 M solution of $\text{BF}_3 \cdot \text{THF}$. This reaction was followed by TLC for ten minutes and this showed that the reaction had gone to completion after 1 minute. To quench and extract this reaction 1 mL of 2 M sodium hydroxide solution was added. This was a highly exothermic step but analysis of

the organic phase showed the successful purification of the desired product. The reaction was completed again under identical parameters but was monitored every 10 seconds for 1 minute by TLC. This showed that the reaction went to completion in 20 seconds. In an attempt to further this reaction 1,2-ethanedithiol was tested with acetophenones and acetoacetates.

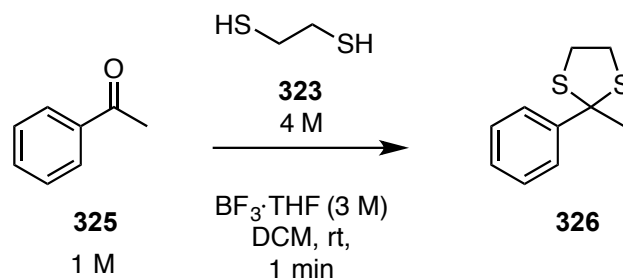

Scheme 2.54: Flow chemistry test reaction between acetophenone (**325**) and 1,2-ethanedithiol (**323**).

The reaction between acetophenone and 1,2-ethanedithiol was set up using identical conditions as described for the reaction between 1,2-ethanedithiol and benzaldehyde. This was monitored by TLC every minute for 10 minutes but by this time the reaction had not gone to completion. In an attempt to increase this reaction rate the concentrations of the starting reagents were all doubled. Hence 0.5 mL of a 1 M solution of acetophenone and 0.5 mL of a 2 M solution of 1,2-ethanedithiol and 1.5 M solution of $\text{BF}_3 \cdot \text{THF}$ were mixed together. This was again monitored every minute for 10 minutes by TLC, and again the reaction had not gone to completion in this time frame. Due to this the concentrations of $\text{BF}_3 \cdot \text{THF}$ and 1,2-ethanedithiol were again doubled. Once the reaction was set up under these conditions then the reaction went to completion in 1 minute. The work up was completed using 4 mL of 2 M sodium hydroxide solution (the volume was

increased due to the increased concentration of 1,2-ethanedithiol) and this proved successful, though again the work up proved to be exothermic.

The successful conditions used in the protection of ketones was attempted with the protection of acetoacetates. This meant that 0.5 mL of a 1 M solution of benzyl acetoacetate was mixed with 0.5 mL of a 4 M solution of 1,2-ethanedithiol and a 3 M solution of $\text{BF}_3 \cdot \text{THF}$. The reaction was monitored every minute for ten minutes by TLC and this showed that the reaction had gone to completion in 1 minute. The quench/extraction was achieved through the use of 4 mL sodium hydroxide solution; however a white precipitate formed during this stage meaning that it was unsuitable for use in the continuous flow system.

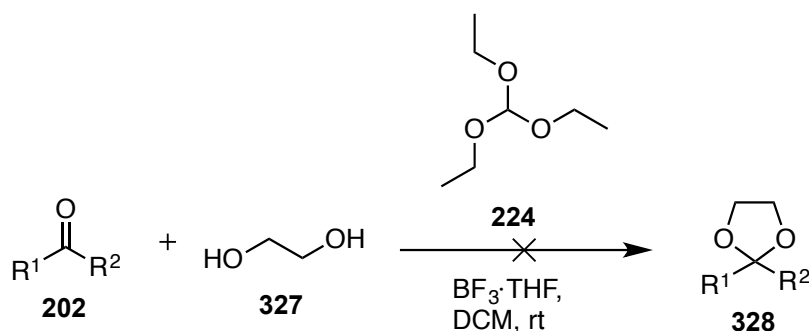

Scheme 2.55: Flow chemistry test reaction between carbonyl groups and ethylene glycol (335).

All three of these reactions were tested with ethylene glycol rather than 1,2-ethanedithiol, using triethyl orthoformate as a dehydrating agent; however in all of these cases the reaction did not go to completion within a ten-minute time frame.

One more reaction was tested after this for its suitability for use in the continuous flow system and that was the halogenation of enamines.

2.6.4. Halogenation of Enaminones in Continuous-Flow

The success of this reaction led to its use in the continuous-flow system. Due to this, all products synthesised, and the corresponding starting materials were fully characterised. Previous products, from test reactions, were only characterised by $^1\text{H-NMR}$.

Enaminones are known to be active toward electrophiles and the carbon that is in the β -position to the nitrogen atom has been well documented in terms of its nucleophilicity.¹⁸¹ One of the reactions that is commonly seen at this site is halogenation. The concept of completing this reaction using continuous flow was an attractive one due to the reported rapid reaction rates¹⁸² and so work began investigating the reaction using *N*-bromosuccinimide (NBS) and *N*-iodosuccinimide (NIS) as the halogenating agents, which would be in excess of the enaminone.

The logic behind using these compounds was that the excess reagent could be reduced to succinimide through use of aqueous sodium thiosulfate solution. The resulting succinimide could then be extracted into the mildly alkaline aqueous phase. Initially bromination with NBS was explored.

The first step in this reaction was to synthesise some enaminones that could be used as test compounds. One of the key thoughts behind this synthesis was to begin by developing enaminones that were very unlikely to react in any other way other than bromination of the alkene carbon in the β -position with regards to the nitrogen atom. A number of enaminones that matched this criterion were

synthesised as well as a selection that were more synthetically interesting (e.g. those that possessed a chiral centre, a furanyl group or a pyridine ring).

The enaminones (**331a-n**) were synthesised using a facile condensation reaction between the symmetrical diketones: dimedone (**329a**), cyclohexanedione (**329b**) and 2,4-pentanedione (**329c**). These were reacted with a series of amines (**319** and **330a-g**) and in the majority of cases were recrystallised from toluene giving high yields of the desired compound with high levels of purity.

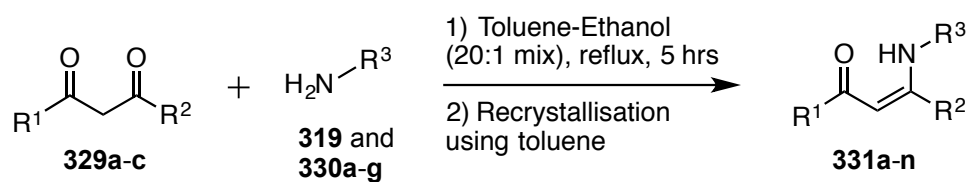

Scheme 2.56: General reaction for the formation of enaminones.

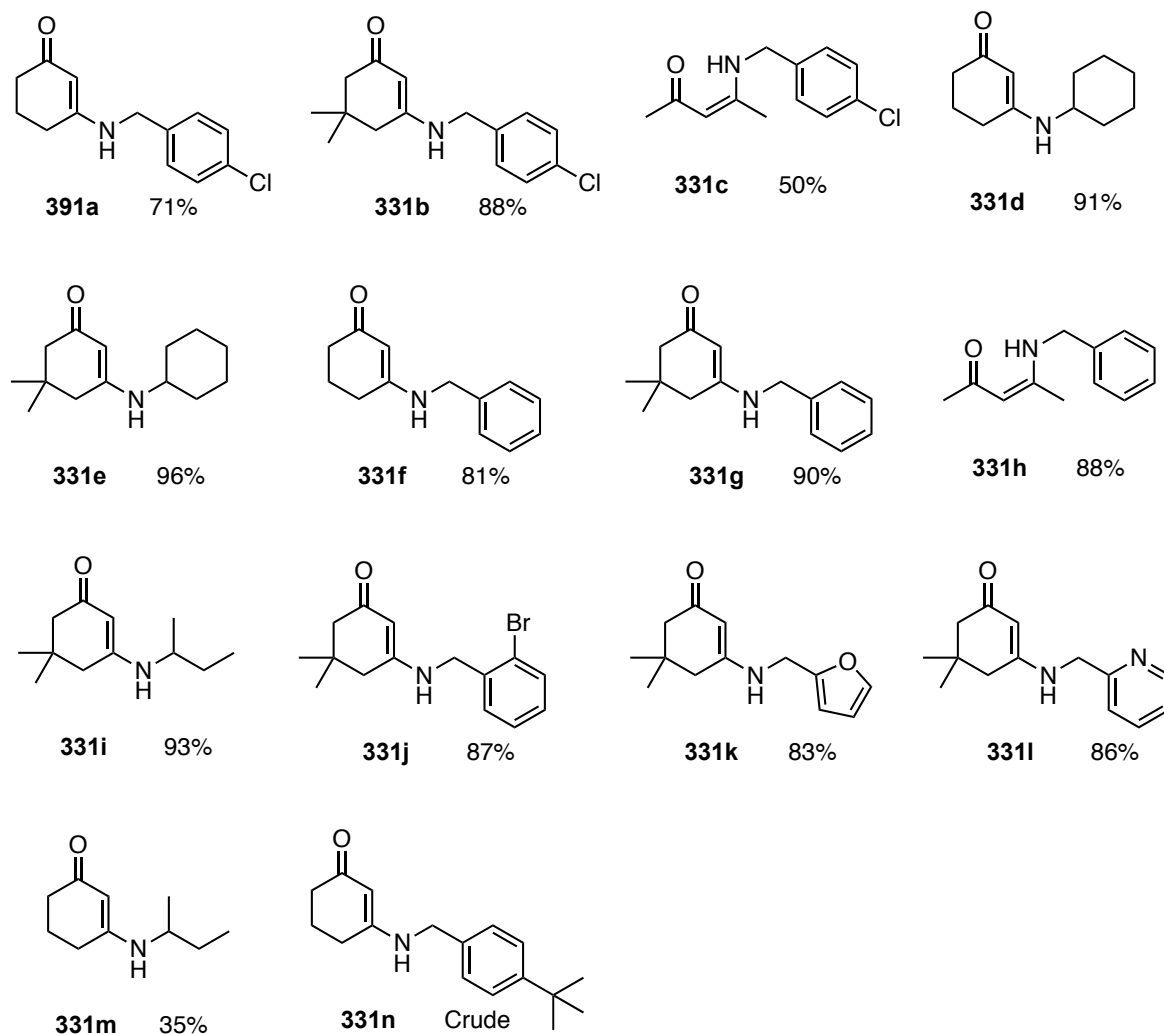
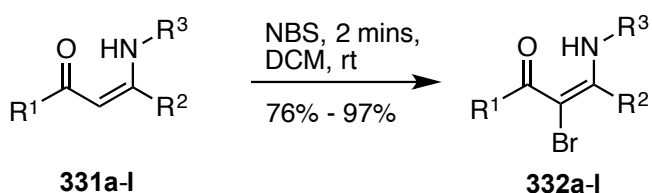

Figure 2.21: Enaminones synthesised.

Although the majority of these were successfully recrystallised from toluene there were three where this was not the case. **331h** did not produce a solid material to recrystallise. Instead this compound underwent an aqueous work-up using

saturated ammonium chloride solution to remove the excess amine. Subsequent washing of the organic phase, drying over magnesium sulfate and concentration under reduced pressure yielded a pure compound (purity determined from $^1\text{H-NMR}$ analysis). **331n** did not yield a solid and after an aqueous work-up with ammonium chloride did not yield a pure compound. $^1\text{H-NMR}$ spectra of this compound showed a number of trace impurities within this compound meant that it would require purification before use. Due to the number of other materials to work with this was not a priority.



Scheme 2.57: Bromination of enaminones using NBS.

Compound **331a** was used to optimise the reaction conditions using NBS. The concentration of the reagents was limited by the solubility of NBS in dichloromethane. The highest concentration that could be obtained without saturating the solution was 0.15 M. Initial tests began using this concentration of NBS along with 0.10 M of enaminone **331a**. As with previous cases the reaction was monitored over a period of ten minutes through TLC analysis. This indicated that the reaction had gone to completion within 2 minutes. The aqueous solution used to quench and extract this reaction was made up of 1 M sodium thiosulfate/sodium bicarbonate. 2 mL of the aqueous solution was added to the organic reaction mixture and this was vigorously shaken for 30 seconds. The organic phase was then separated, concentrated and analysed by $^1\text{H-NMR}$. This

showed the presence of some succinimide still, along with the desired product and a trace impurity.

Upon repeating the reaction using identical conditions but quenching at two minutes the trace impurity wasn't present in the $^1\text{H-NMR}$ spectrum (though succinimide was still an issue). This suggested that the reaction is time dependent and would begin to overbrominate should the reaction be left for too long. In an effort to test this a solution of 0.1 M **331a** was mixed with 0.15 M NBS and the reaction was left for 2 hours. After this time had elapsed the reaction was quenched in the normal manner and the organic material analysed. This showed only the undesired product. The time dependency of this reaction made it all the more interesting to study and also meant that the reaction was more suitable to continuous flow than initially thought.

The issue that remained however was the presence of the succinimide after the reaction. It was obvious that some succinimide was being removed into the aqueous phase as the integration of the CH_2 peak showed fewer equivalents than went into the reaction. In an attempt to rectify this situation the volume of aqueous solution used in the quench/extraction step was increased. This had a positive effect in the sense that the integrated value of the succinimide CH_2 peak decreased; however the effect was very slight.

A serendipitous error of making up the aqueous solution without the presence of sodium bicarbonate showed that this did not have either a positive or an adverse effect on the removal of succinimide. This showed that the bicarbonate did not

generate a strong enough alkaline solution to remove the succinimide. The pK_a of succinimide is 9.6¹⁸³ and this is too high to be deprotonated by bicarbonate (carbonic acid), which has a pK_a of 6.4. The pK_a of carbonate (bicarbonate) is 10.3 and this led to use of a stronger base to deprotonate the succinimide.

A change of base from sodium bicarbonate to potassium carbonate showed a significant decrease in the intensity of the succinimide peak upon analysis of the organic material. Coupling this with the idea of using a more dilute aqueous solution to ensure that the aqueous phase wasn't becoming saturated. A new aqueous phase was made up of 0.1 M sodium thiosulfate/potassium carbonate. This was used to quench/extract the reaction after two minutes had passed and this showed only a minor succinimide peak in the product.

In all these cases the volume of the organic solution and the volume of aqueous solution were matched. In the next trial run the volume of the aqueous solution was four times greater than that of the organic solution. After shaking the biphasic mixture vigorously and separating the phases the organic material was dried, concentrated and analysed. This showed that all succinimide had been removed from the reaction.

This success meant that the reaction could also be tested using NIS. The main issue seen with NIS was that it was even less soluble than NBS in dichloromethane. The maximum concentration of NIS obtained was 0.021 M. Hence 1.5 mL of 0.021 M NIS was reacted with 1 mL of 0.03 M **339a** solution. This was monitored by TLC every minute for ten minutes. At the end of this time period

TLC analysis showed that the reaction had not gone to completion. In an effort to change this, the volume of NIS was increased (as the concentration could not be increased). In a second attempt the same volume of **331a** solution was used but this was with 2.9 mL of 0.021 M NIS solution. This was again monitored by TLC and it was found that this reaction went to completion within 2 minutes. This was quenched using the potassium carbonate/sodium thiosulfate mixture and the succinimide was successfully extracted. Using this volume ratio with NBS rather than NIS resulted in the major product being the presumed overbrominated compound. In an effort to reduce any chance of overbromination the concentration of NBS and enaminone was altered. The reaction was trialed with 1 mL 0.1 M enaminone and 1 mL 0.106 M NBS. This reaction still went to completion in the same time frame and aqueous extraction was still successful using 4 mL of a 0.1 M solution of sodium thiosulfate/potassium carbonate.

A further test was performed using 1-butyl-3-methylimidazolium tribromide ([Bmim]Br₃) as the halogenating agent. This is an ionic liquid and there have been several reported cases where this has been used successfully in the bromination of phenols and activated aromatics.¹⁸⁴ This was tested and quenched in the same manner as had been found to be effective for NBS. ¹H-NMR analysis showed that the desired compound was present (after three minutes of reaction time) but that there was some of the imidazolium reagent present in the organic phase. This was put on hold for the time being and attention focused on the use of NBS as the halogenating agent.

With this information in hand the time came to introduce this reaction to the continuous flow system, but before this could be done, the three pumps being used needed to be calibrated in order to determine if their flow rates matched up with what was depicted on the control panel. Both the Milton Roy ConstaMetric III Metering pump and the LKB Bromma 2150 HPLC pump matched in terms of their theoretical pump speed and their actual pump speed. With the Waters 510 HPLC pump however this was not the case. Instead the actual pump speed was 2.08 times faster than the indicated pump speed.

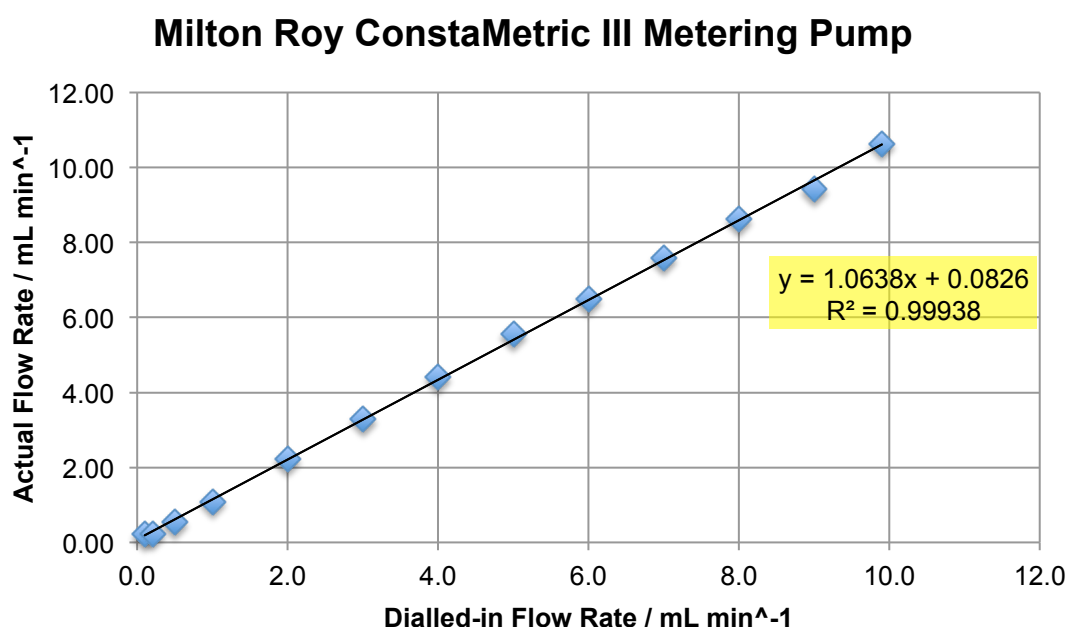

Graph 2.1: Calibration of the Milton Roy ConstaMetric III Metering pump.

LKB Bromma 2150 HPLC Pump

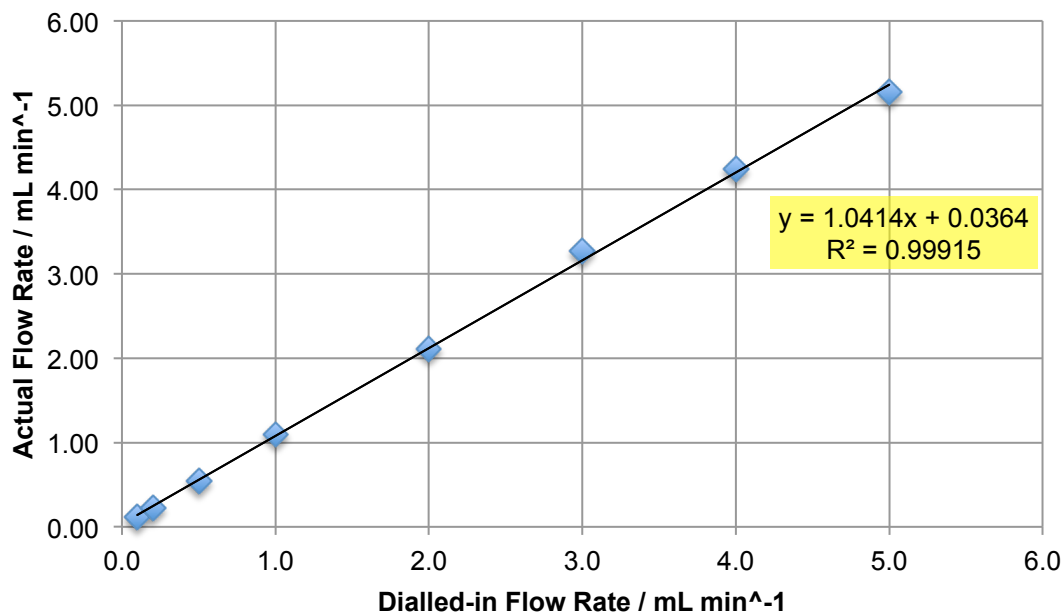

Graph 2.2: Calibration of the LKB Bromma 2150 HPLC pump.

Waters 510 HPLC Pump

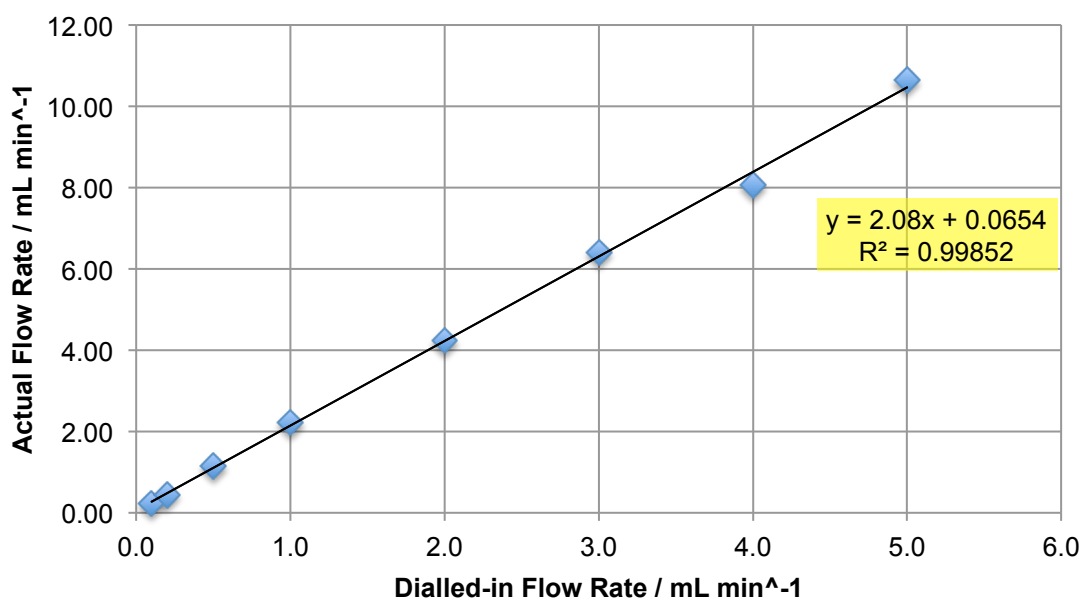

Graph 2.3: Calibration of the Waters 510 HPLC pump.

A completely linear plot was obtained with all three pumps and this meant that the pump settings could be adjusted to produce a flow rate of 1 mL min^{-1} . The initial test of the continuous flow system was completed using enaminone **331a** as the conditions had already been optimised in batch. The 0.10 M solution of enaminone **331a** was placed in an injection loop of 3.0 mL length whilst the 0.106 M solution of NBS was placed in an injection loop of 4.1 mL . The NBS was injected into the flow stream 20 seconds prior to the addition of the enaminone compound as this meant that there was a 20 second overlap at the start of the reaction and a 46 second overlap at the end of the enaminone injection to ensure that no enaminone was without NBS to react with. Both the enaminone stream and the NBS reagent stream were pumping at 1 mL min^{-1} . These both entered a reaction loop of 4.7 mL giving a reaction time of 2 minutes and 21 seconds and at the end of this loop the organic stream immediately encountered the aqueous stream to quench the reaction (running at 4 mL min^{-1}). This biphasic mixture was passed into a mixing column (made up of several small PTFE coated stirrer bars that were placed in a glass column and stationed over a magnetic stirrer. This was set to full speed and enabled the rapid mixing of the two phases. After passing through this column the tubing continued on to a separation vessel, which was being monitored by the webcam system developed for this purpose (using a Python script, incorporating the OpenCV library).

Initial tests with the webcam system showed success for the first four minutes but then as a more intensely coloured solution entered the separation vessel the webcam proved no longer able to detect the float. This issue was rectified by relaxing the parameters responsible for determining the hue value of the selected

colour (i.e. the detection was made more tolerant to the presence of other colours). When this was completed the experiment was repeated using identical conditions and proved to be far more successful.

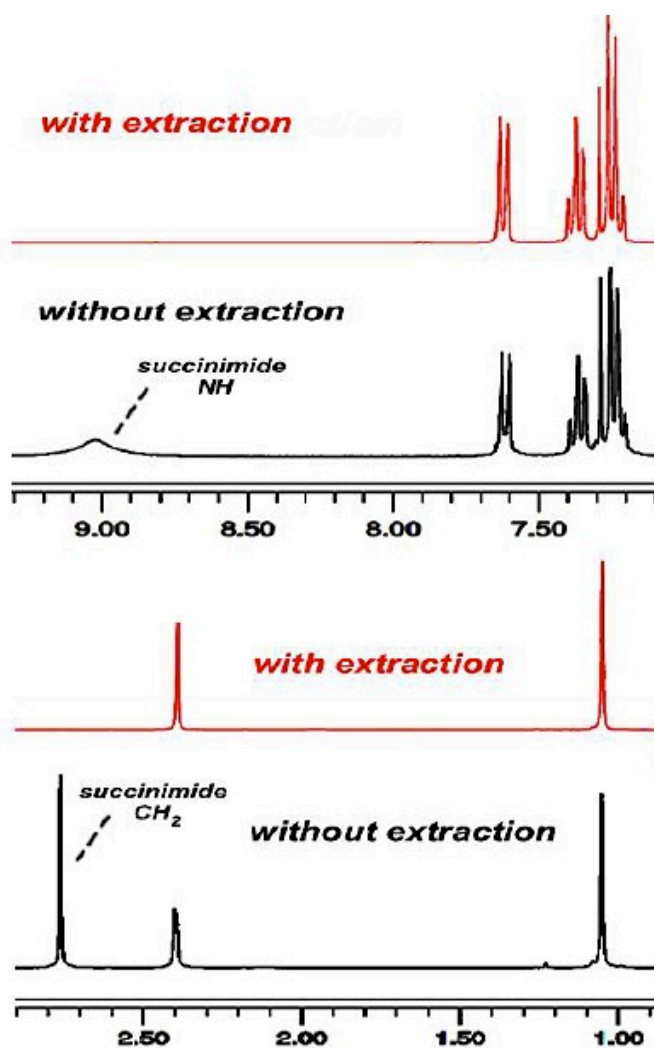

Figure 2.22: NMR spectra of the reaction product with extraction using the aqueous solution (in red) and without extraction (in black). Taken with permission from reference 175.

In an effort to show that the succinimide was successfully being extracted by the aqueous solution the reaction was completed both with and without the aqueous

extraction. The $^1\text{H-NMR}$ spectra of both these runs were then compared as is shown in Figure 2.22. The spectrum in red corresponds to the run that included extraction with the aqueous solution. The spectrum in black corresponds the run that bypassed the aqueous extraction.

The yield of the brominated compound was pleasingly high and after removal of solvent showed very high purity, meaning there was no need for purification steps, something that would make this especially useful if the compound was taking part in a multi-step reaction using a continuous flow system.

Enaminones **331a-I** were reacted in the continuous flow system using NBS as the halogenating agent. In some cases the flow rate had to be adjusted slightly due to trace quantities of overbrominated product being present or due to the leftover presence of a trace of starting material; however in all cases the flow rate was very close to 1 mL min^{-1} (for full details please see experimental section 5.7.). Several flow runs were completed in each laboratory session and despite never dismantling the apparatus there was no cross contamination of compounds seen. At the end of each day distilled water was pumped through the aqueous-out pump to avoid the settling or build up of any particulates that had been removed. It was noted that the aqueous waste developed a fine yellow precipitate upon standing, which could perhaps be elemental sulfur from the thiosulfate.

The main drawback to this set up is that if the colouration exceeds beyond the parameters listed or if the solutions were the same colour of the float then the position of the float may be lost by the system and a manual takeover needed.

Despite this it is possible to adjust the hue tolerances for other shades and colours and work would be needed to determine the most suitable one. Although this is the case the parameters used in this set up proved very tolerable to intense yellow solutions. In Figure 2.23 real time images can be seen during the bromination of enaminone **331i**. This was one of the most intensely coloured compounds. Camera images (i) show the float as being magnified due to the cylindrical vessel whilst the processed images (ii) show (in white) what the computer programme identifies as possessing the correct hue. The small blue circles on the image represent the upper and lower bounds. These bounds are limits set by the user to represent the highest and lowest position that the float can reach. The system then utilises the position of the float in reference to these bounds to determine the pump speed.

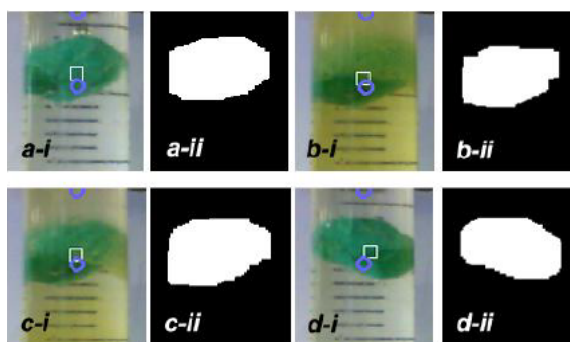

Figure 2.23: (i) Camera images and (ii) processed images focusing on the separating vessel at a) 0 mins, b) 5 mins 28 secs, c) 7 mins 43 secs and d) 10 mins 17 secs. Taken with permission from reference 175.

Currently, work is taking place introducing some of the alternative reactions tested to the continuous flow set up (see Figure 2.20) including the use of NIS as a

halogenating agent for enamines; the reaction between aldehydes and methyl carbazate and the protection of aldehydes and ketones with 1,2-ethanedithiol.

Some interest is also focused on the use of the continuous flow system in a multi-step reaction sequence to synthesise synthetically interesting and potentially biologically active compounds.

2.7. Future Work

Whilst progressing through these projects a number of questions and future possibilities have arisen that could be investigated in the future. During the synthesis of the spiro compound the main issue seen was the hydrogenation of the alkyne. As described in section 2.1. Dr. Mei Shi (a visiting scholar from Nanjing) discovered that this was an extremely time sensitive reaction that was also probably dependent on the surface-area-to-volume ratio. In order to overcome this, one idea is to combine this project with the use of a continuous flow system. This would use a liquid-gas reactor and would allow for the fine control of the residence times where the organic solution containing the substrate and the catalyst would be in contact with the hydrogen gas (under pressure). This could then be immediately quenched and ideally undergo an extraction/purification step upon leaving the reaction vessel providing the desired product. Optimisation of the conditions within the continuous flow system would obviously require some work. Prior to this (and the changing of the reaction vessel) the other reactions would be completed (and in some cases are in the process of being completed). This would mean the flow system would be tested in terms of gravity-based liquid-liquid inline extraction using both an acidic and a basic quench/extraction solution.

A lot of work has been completed on the tetrahydropyran methodology over the course of these projects and it would be extremely interesting to apply this to natural product synthesis. A number of examples that could potentially be achieved without too much change to the method include (-)-centrolobine (**19**),³⁸

FR901464 (**333**) (isolated from *Pseudomonas* sp.)¹⁸⁵ or diospongin A (**334**), a natural product demonstrating anti-osteoporotic activity.¹⁸⁶

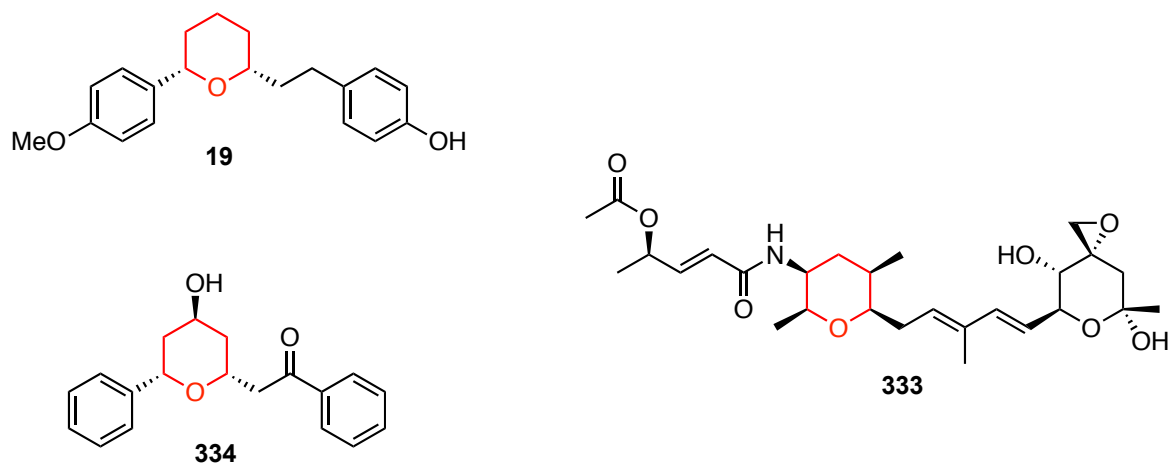

Figure 2.24: Potential natural products for future synthetic investigations.

There is also the possibility of adapting this methodology in two ways. The first would use methyl cyanoacetate rather than dimethyl malonate (**276**) to incorporate a nitrogen atom and this could open up a pathway to the stereoselective synthesis of variously substituted piperidines. Another interesting possibility would be to look at the use of pyrrole rather than furan as the electron-rich substituent to facilitate epimerisation under acidic conditions. This would not only allow for the incorporation of nitrogen into any further transformations of the group but highly functionalised and substituted pyrroles can easily be synthesised through the Barton-Zard reaction using isocyanates and nitroalkenes.¹⁸⁷

Alongside this it would be possible to synthesise the 2,4-disubstituted tetrahydropyrans and the 2,4,5-trisubstituted tetrahydropyrans enantioselectively. This could be achieved by an asymmetric Michael reaction and a number of these

have been described in the literature using dimethyl malonate. One example is shown in work by He and co-workers using dimethyl malonate and chalcones in 2014.¹⁸⁸ This employs *cinchona* alkaloids-based bifunctional tertiary amine-thioureas that possess multiple hydrogen-bond donors to achieve the enantioselectivity.

I would also like to continue the development of the Grignard reagent and take the iodide described in Section 2.2. through to the coupling step with various aldehydes, imines or Elman's sulfinamides. This could be completed either as the Grignard reagent or, *via* a transmetallation reaction, as the organozinc compound. I would also like to revisit the cyclisation step in the synthesis of difuranyl tetrahydropyrans (see Section 2.5.). This would allow the investigation of what is happening during the reaction (i.e. is selective decomposition being seen) whilst also allowing further investigation into the aldehyde produced as a side product as this could potentially have use in the synthesis of the corresponding tetrahydropyran.

3. Conclusions

This thesis postulated that the previous work within the group on the acid-catalysed stereoselective synthesis of tetrahydropyrans could be built upon and expanded. Initially this was to be completed by looking at the synthesis of 2,4-disubstituted tetrahydropyrans; before observing the more interesting double diastereoselectivity of the 2,4,5-trisubstituted tetrahydropyrans. Another realm that was investigated during the course of this work was the development of a suitable organometallic coupling compound that could be involved in reactions with aldehydes, imines and sulfinamides with the aim being focused on the stereoselective synthesis of both tetrahydropyrans and piperidines. Finally investigations were conducted into the development of a continuous-flow liquid-liquid extractor that could be used effectively with reactions to yield only the desired product, in other words the excess material and any by-products/impurities would be extracted from the product into the aqueous stream.

The stereoselective synthesis of 2,4-disubstituted and 2,4,5-trisubstituted tetrahydropyrans was achieved through the use of an acid catalysed cyclisation reaction. These reactions were both under thermodynamic control and the most favoured diastereoisomer was that which placed all the substituents in the equatorial position on a chair conformer. This stereoselectivity came from the reversibility of the cyclisation reaction under acidic conditions and the ability of the furanyl chiral centre to epimerise in this environment. Base cyclisation showed that these reactions needed acidic conditions in order to facilitate the epimerisation and

so under basic conditions no stereoselectivity in the cyclisation was observed. Work was also completed to enable single crystal X-ray structures to be obtained of the major tetrahydropyran diastereoisomer in order to confirm the stereochemical findings beyond any doubt.

This work contributes well to the literature because this is an efficient route to tetrahydropyrans, an area of research that has received much attention over the years and an area that remains of key importance due to the number of natural products that possess the moiety. The review papers of Clarke and co-workers in 2006¹⁸⁹ and 2014⁸⁴ and the review by Perry, Rychnovsky and Sizemore in 2014⁹⁶ all show the amount of effort and research that is going into this area and it is generally focused on the Prins cyclisation, hetero-Diels-Alder reaction, oxy-Michael cyclisation and metal-catalysed cyclisation. The exploitation of the epimerisable nature of the furanyl group under acidic conditions has received very little attention outside of the group and yet has the potential to be used in stereoselective syntheses of natural products due to the ability of the furanyl group to undergo a multitude of transformations reported in the literature over the past century.

Despite its potential uses the compound does need to be subjected to acidic conditions and may not be suitable for some functionalities at late stages in a total synthesis. Another drawback to the synthesis described in this thesis is that aromatic compounds are always present in the 4-position on the tetrahydropyran ring. This is an obvious drawback if this is an undesired group in the desired compound.

To approach the synthesis of tetrahydropyrans *via* an alternative route, attempts were made to synthesise an appropriate organometallic coupling compound that would introduce the furanyl chiral centre. Work was unsuccessful beginning with benzotriazole but more success was seen starting with γ -butyrolactone and 5-methylfuran. This synthetic route relied on more traditional chemistry and yielded the iodide in a good overall yield; however the actual Grignard formation and reaction have yet to be properly tested. Should these steps proceed successfully then the route would theoretically be an efficient way to reach substituted tetrahydropyrans and piperidines. Again this knowledge could be used in the stereoselective synthesis of the tetrahydropyran moiety when engaging in the total synthesis of natural products/biologically active compounds; however this depends on whether any issues are seen in the Grignard reaction or subsequent cyclisation.

In an area away from stereoselective synthesis this thesis has reported on the successful development of a continuous-flow liquid-liquid extractor that has been used in the bromination of enamines, where both quenching the reaction and extracting the succinimide side product were completed with a suitable aqueous stream. Work has also been completed on the development of conditions for a number of other reactions that could be applied to this system and these are currently going to be tested, if they are not in the process of being tested already.

The area of flow chemistry is receiving a lot of attention in the literature, especially from the Ley group in the United Kingdom. The system discussed in this thesis is focused on inline liquid-liquid extraction and the key concept is that it is monitored

via a computer system meaning that almost the entire process (excluding the removal of the flask containing the product and the insertion of starting materials) is automated and can be constructed from relatively inexpensive technologies. The paper reporting this information contains the details needed to set up a similar system and this means that other researchers can develop this technology themselves.

Overall the original aims of this thesis have been met and the research has contributed knowledge to the current literature, with potential applications for future work as discussed throughout Section 2. Some of this work has already been started within the group and will be reported on in due course.

4. References

1. S. Jain, I. G. Rathish and R. Sankaran, *Int. J. Pharm. Pharm. Sci.* **2013**, 5, 4, 33
2. H. Kubinyi, *J. Braz. Chem. Soc.* **2002**, 13, 6, 717
3. W. R. J. D. Galloway, A. Isidro-Llobet and D. R. Spring, *Nature Communications*, **2010**, 1
4. D. A. Dias, S. Urban and U. Roessner, *Metabolites*, **2012**, 2, 303
5. B. Schmidt, D. M. Ribnicky, A. Poulev, S. Logendra, W. T. Cefalu and I. Raskin, *Metabolism*, **2008**, 57
6. B. B. Mishra and V. K. Tiwari, *Eur. J. Med. Chem.* **2011**, 46, 10, 4769
7. A. Zivanovic, *Marine Natural Products: Isolation, Screening and Analogue Synthesis*, **2012**, PhD Thesis, University of Wollongong
8. G. Y. Ku, D. H. Ilson, L. H. Schwartz, M. Capanu, E. O'Reilly, M. A. Shah, D. P. Kelsen and G. K. Schwartz, *Cancer Chemother. Pharmacol.* **2008**, 62, 875
9. C. K. Skepper, *Marine-derived Heterocycles: Structural, Synthetic and Biological Investigations*, **2009**, PhD Thesis, University of California
10. P. M. Dewick, *Medicinal Natural Products: A Biosynthetic Approach (3rd Edition)*, **2009**, Published by John Wiley & Sons Ltd. in West Sussex
11. K. Roth, *Strychnine: From Isolation to Total Synthesis – Part 1*, 5th May **2015**, Article published in ChemViews magazine
12. I. Šafařík and M. Šafaříková, *Biologically Active Compounds and Xenobiotics: Magnetic Affinity Spectrums*, **2000**, Published by Academic Press in Massachusetts

13. J. N. Merlin, I. V. S. N. Christudas, P. P. Kumar, M. Kumar and P. Agastian, *J. Acad. Indus. Res.* **2012**, 1, 5, 281
14. S. Malik, R. M. Cusidó, M. H. Mirjalili, E. Moyano, J. Palazón and M. Bonfill, *Process Biochemistry*, **2011**, 46, 23
15. Y. Okamoto and T. Ikai, *Chem. Soc. Rev.* **2008**, 37, 2593
16. J. E. Ridings, *Chapter 36: The Thalidomide Disaster, Lessons from the Past, from Teratogenicity Testing: Methods and Protocols*, **2013**, Published by Humana Press in London
17. J. B. Bartlett, K. Dredge and A. G. Dalgleish, *Nature Reviews Cancer*, **2004**, 4, 314
18. Y. Hirata and D. Uemura, *Pure & Appl. Chem.* **1986**, 58, 5, 701
19. D. Uemura, K. Takahashi and T. Yamamoto, *J. Am. Chem. Soc.* **1985**, 107, 4976
20. T. D. Aicher, K. R. Buszek, F. G. Fang, C. J. Forsyth, S. H. Jung, Y. Kishi, M. C. Matelich, P. H. Scola, D. M. Spero and S. K. Yoon, *J. Am. Chem. Soc.* **1992**, 114, 3162
21. A. Extance, *Organic Odysseys*, July **2015**, Article published in Chemistry World
22. D. H. Marchbank, *Eunicea fusca and Pseudopterogorgia elisabethae as a Resource for Bioactive Diterpenes: A Journey through Drug Discovery, Glycosylation Chemistry and Chemical Proteomics*, **2013**, PhD Thesis, University of Prince Edward Island
23. D. A. Dabydeen, J. C. Burnett, R. Bai, P. Verdier-Pinard, S. J. H. Hickford, G. R. Pettit, J. W. Blunt, M. H. G. Munro, R. Gussio and E. Hamel, *Mol. Pharmacol.* **2006**, 70, 1866

24. S. L. Schreiber, *Proc. Natl. Acad. Sci. USA*, **2011**, 108, 17, 6699
25. R. Jimmidi, S. Krishna, R. Guduru and P. Arya, *Org. Lett.* **2015**, 17, 468
26. M. J. Yu, W. Zheng and B. M. Seletsky, *Nat. Prod. Rep.* **2013**, 30, 1158
27. A. Lorente, K. Makowski, F. Albericio and M. Álvarez, *Ann. Mar. Biol. Res.* **2014**, 1, 1, 1003
28. B. Weigett, J. L. Peterse and L. J. van't Veer, *Nature*, **2005**, 5, 591
29. S. Narayan, E. M. Carlson, H. Cheng, H. Du, Y. Hu, Y. Jiang, B. M. Lewis, B. M. Seletsky, K. Tendyke, H. Zhang, W. Zheng, B. A. Littleford, M. J. Towle and M. J. Yu, *Bioorg. Med. Chem. Lett.* **2011**, 21, 1630
30. H. Jin, J. Uenishi, W. J. Christ and Y. Kishi, *J. Am. Chem. Soc.* **1986**, 108, 18, 5644
31. K. Takai, M. Tagashira, T. Kuroda, K. Oshima, K. Utimoto and H. Nozaki, *J. Am. Chem. Soc.* **1986**, 108, 6048
32. I. Thomé, A. Nijs and C. Bolm, *Chem. Soc. Rev.* **2012**, 41, 979
33. T. Washio, R. Yamaguchi, T. Abe, H. Nambu, M. Anada and S. Hashimoto, *Tetrahedron*, **2007**, 63, 48, 12037
34. J. –H. Xie, L. –C. Guo, X. –H. Yang, L. –X. Wang and Q. –L. Zhou, *Org. Lett.* **2012**, 14, 18, 4758
35. P. A. Clarke and W. H. C. Martin, *Tetrahedron*, **2005**, 61, 5433
36. I. Arevalo, B. Ward, R. Miller, T. –C. Meng, E. Najjar, E. Alvarez, G. Matlashewski and A. Llanos-Cuentas, *Clin. Infect. Dis.* **2001**, 33, 1847
37. C. Galeffi, C. Gilulio-Casinovi and G. B. Marini-Bettolo, *Gazz. Chim. Ital.* **1965**, 95
38. F. Colobert, R. Des Mazery, G. Solladié and M. C. Carreño, *Org. Lett.* **2002**, 4, 10, 1723

39. A. Solladié-Cavallo, J. Suffert, A. Adib and G. Solladié, *Tetrahedron Letters*, **1990**, 31, 46, 6649
40. M. –K. Sun and D. L. Alkon, *CNS Drug Reviews*, **2006**, 12, 1, 1
41. G. R. Pettit, C. L. Herald, D. L. Doubek and D. L. Herald, *J. Am. Chem. Soc.* **1982**, 104, 6846
42. C. S. Garcia, R. E. Curiel, J. M. Mwatibo, S. Pestka, H. Li and J. Espinoza-Delgado, *J. Immunol.* **2006**, 117, 2707
43. B. Helford, *Chem. Eng. News*, **2011**, 89, 43, 10
44. A. B. Smith III, T. M. Razler, J. P. Giavarri, T. Hirose, T. Ishikawa and R. M. Meis, *J. Org. Chem.* **2008**, 73, 1192
45. K. R. Hornberger, C. L. Hamblett and J. L. Leighton, *J. Am. Chem. Soc.* **2000**, 122, 12894
46. C. Escolano, M. Amat and J. Bosch, *Chem. Eur. J.* **2006**, 12, 8198
47. P. S. Watson, B. Jiang and B. Scott, *Org. Lett.* **2000**, 2, 23, 3679
48. R. Figueroa, *Application of the Prins Cyclization to the Synthesis of Tetrahydropyran Rings of Lasonolide A*, **2004**, PhD Thesis, Ohio State University
49. K. –P. Chan and T. –P. Loh, *Org. Lett.* **2005**, 7, 20, 4491
50. S. Yamabe, T. Fukuda and S. Yamazaki, *Beilstein J. Org. Chem.* **2013**, 9, 476
51. C. Olier, M. Kaafarani, S. Gastald and M. P. Bertrand, *Tetrahedron*, **2010**, 66, 413
52. J. Yang, G. S. Viswanathen and C. –J. Li, *Tetrahedron Letters*, **1999**, 40, 1627
53. R. Jasti, C. D. Anderson and S. D. Rychnovsky, *J. Am. Chem. Soc.* **2005**, 127, 9939

54. S. R. Crosby, J. R. Harding, C. D. King, G. D. Parker and C. L. Willis, *Org. Lett.* **2002**, 4, 20, 3407
55. S. Marumoto, J. J. Jaber, J. P. Vitale and S. D. Rychnovsky, *Org. Lett.* **2002**, 22, 3919
56. C. S. Barry, N. Bushby, J. R. Harding and C. L. Willis, *Org. Lett.* **2005**, 7, 13, 2683
57. C. S. Barry, N. Bushby, J. R. Harding, R. A. Hughes, G. D. Parker, R. Roe and C. L. Willis, *Chem. Commun.* **2005**, 3727
58. K. R. K. K. Reddy, I. M. L. Rosa, A. C. Doriguetto, E. L. Bastos and L. F. Silva, *Molecules*, **2013**, 18, 11100
59. F. Liu and T. -P. Loh, *Org. Lett.* **2007**, 9, 11, 2063
60. X. Han, G. Peh and P. E. Floreancig, *Eur. J. Org. Chem.* **2013**, 1193
61. V. V. Vintonyak, B. Kunze, F. Sasse and M. E. Maier, *Chem. Eur. J.* **2008**, 14, 11132
62. V. V. Vintonyak and E. M. Maier, *Org. Lett.* **2008**, 10, 6, 1239
63. C. F. Nising and S. Bräse, *Chem. Soc. Rev.* **2012**, 41, 988
64. H. Fuwa, H. Yamaguchi and M. Sasaki, *Org. Lett.* **2010**, 12, 8, 1848
65. H. Kim, Y. Park and J. Hong, *Angew. Chem. Int. Ed.* **2009**, 48, 7577
66. Y. Kawanami, S. Murao, T. Ohga and N. Kobayashi, *Tetrahedron*, **2003**, 59, 8411
67. M. G. Banwell, C. T. Bui, T. T. Pham and G. W. Simpson, *J. Chem. Soc. Perkin Trans. 1*, **1996**, 967
68. P. R. Blakemore, C. C. Browder, J. Hong, C. M. Lincoln, P. A. Nagorny, L. A. Robarge, D. J. Wardrop and J. D. White, *J. Org. Chem.* **2005**, 70, 5449

69. J. M. Bentancort, V. S. Martín, J. M. Padrón, J. M. Palazón, M. A. Ramírez and M. A. Soler, *J. Org. Chem.* **1997**, 63, 4570
70. L. Vares, *Stereoselective Synthesis of Tetrahydrofuran and Tetrahydropyran Derivatives by use of Asymmetric Horner-Wadsworth-Emmons and Ring Closure Reactions*, **2000**, PhD Thesis, University of Tartu
71. L. Wang and D. Menche, *J. Org. Chem.* **2012**, 77, 10811
72. L. Ferrié, S. Reymond, P. Capdevielle and J. Cossy, *Org. Lett.* **2007**, 9, 13, 2461
73. M. Kanematsu, M. Yoshida and K. Shishide, *Angew. Chem. Int. Ed.* **2011**, 50, 2618
74. I. Paterson, M. J. Coster, D. Y. –K. Chen, J. L. Aceña, J. Bach, L. E. Keown and T. Trieselmann, *Org. Biomol. Chem.* **2005**, 3, 2420
75. I. Paterson, D. Y. –K. Chen, M. J. Coster, J. L. Aceña, J. Bach, K. R. Gibson, L. E. Keown, R. M. Oballa, T. Trieselmann, D. J. Wallace, A. P. Hodgson and R. D. Norcross, *Angew. Chem.* **2011**, 113, 4179
76. K. A. Jørgenson, *Angew. Chem. Int. Ed.* **2000**, 39, 3558
77. S. J. Danishefsky and M. P. DeNinno, *Angew. Chem. Int. Ed.* **1987**, 26, 15
78. H. Pellissier, *Tetrahedron*, **2009**, 65, 2839
79. S. Danishefsky, J. F. Kerwin Jr. and S. Kobayashi, *J. Am. Chem. Soc.* **1982**, 104, 358
80. M. A. McCarrick, Y. Wu and K. N. Houk, *J. Am. Chem. Soc.* **1992**, 114, 1499
81. J. Mulzer, F. Meyer, J. Buschmann and P. Luger, *Tetrahedron Letters*, **1995**, 36, 20, 3503
82. M. Robertson, A. S. Jepsen and K. A. Jørgensen, *Tetrahedron*, **2001**, 57, 907

83. A. G. Dessetter, T. F. Janison and E. N. Jacobsen, *Angew. Chem. Int. Ed.* **1999**, 38, 2398
84. N. M. Nasir, K. Ermanis and P. A. Clarke, *Org. Biomol. Chem.* **2014**, 12, 3323
85. M. J. Twiner, N. Rehmman, P. Hess and G. J. Doucette, *Mar. Drugs*, **2008**, 6, 39
86. D. A. Evans, L. Kværnø, T. B. Dunn, A. Beauchemin, B. Raymer, J. A. Mulder, E. J. Olhava, M. Juhl, K. Kagechika and D. A. Favor, *J. Am. Chem. Soc.* **2008**, 130, 16295
87. A. Guérinol, A. Serra-Muns, C. Bensoussan, S. Reymond and J. Cossy, *Tetrahedron*, **2011**, 67, 5024
88. B. M. Trost and A. Tenaglia, *Tetrahedron Letters*, **1988**, 29, 24, 2927
89. A. Aponick, C. -Y. Li and B. Biannic, *Org. Lett.* **2008**, 10, 4, 669
90. A. S. K. Hashmi and M. Rudolph, *Chem. Soc. Rev.* **2008**, 37, 1766
91. H. E. Dimmitt, *Gold (I) Catalyzed Rearrangements of Allyl Aryl Ethers: Mechanistic and Synthetic Studies*, **2011**, Masters Thesis, Western Washington University
92. H. Qian, X. Han and R. A. Widenhoefer, *J. Am. Chem. Soc.* **2004**, 126, 9536
93. J. Uenishi and M. Ohmi, *Angew. Chem. Int. Ed.* **2005**, 44, 2756
94. V. Böhrsch and S. Blechert, *Chem. Commun.* **2006**, 1968
95. M. P. Garcia, *New Synthetic Methodologies Using Enyne Olefin Metathesis: Application in Natural Product Synthesis*, **2010**, PhD Thesis, Technical University of Berlin
96. M. A. Perry, S. D. Rychnovsky and N. Sizemore, *Synthesis of Saturated Oxygenated Heterocycles I*, **2014**, Published by Springer-Verlag in Berlin

97. S. H. Hong, D. P. Sanders, C. W. Lee and R. H. Grubbs, *J. Am. Chem. Soc.* **2005**, 127, 17160
98. M. T. Crimmins and G. S. Vanier, *Org. Lett.* **2006**, 8, 13, 2887
99. K. C. Nicolaou, C. V. C. Prasad, P. K. Somers and C. –K. Hwang, *J. Am. Chem. Soc.* **1989**, 111, 5330
100. K. J. Hale, M. G. Hummersone and G. S. Bhatia, *Org. Lett.* **2000**, 2, 15, 2189
101. D. L. Wright, *Chem. Innov.* **2001**, 31, 10, 17
102. M. Prokešová, Š. Toma, A. Kennedy and G. R. Knox, *Tetrahedron*, **1998**, 54, 9175
103. M. J. Palframan and G. Pattenden, *Chem. Commun.* **2014**, 50, 7223
104. O. Achmatowicz Jr., P. Bakowski, B. Szechnar, Z. Zweirzchowska and A. Zamojski, *Tetrahedron*, **1971**, 27, 10, 1973
105. M. O'Brien, S. Cahill and L. A. Evans, *Chem. Commun.* **2008**, 5559
106. Y. L. Chow, C. L. Colón and J. N. S. Tam, *Can. J. Chem.* **1968**, 46, 2821
107. M. O'Brien, A. Leach, R. J. Armstrong, K. Chong and R. Sheridan, *Org. Biomol. Chem.* **2012**, 10, 2392
108. S. Cahill and M. O'Brien, *Tetrahedron Letters*, **2006**, 47, 3665
109. F. Perron and K. F. Albizati, *Chem. Rev.* **1989**, 89, 1617
110. T. Shono, Y. Matsumura, K. Tsubata, K. Uchida, T. Kanazawa and K. Tsuda, *J. Org. Chem.* **1984**, 49, 20, 3711
111. J. Åhman and P. Somfai, *Tetrahedron*, **1992**, 48, 43, 9537
112. A. Tursan, B. Aboab, A. –S. Martin, M. –E. Sinibaldi and I. Canet, *Synlett*, **2005**, 15, 2397
113. E. G. Occhiato, C. Prandi, A. Ferrali, A. Guarna and P. Venturello, *J. Org. Chem.* **2003**, 68, 25, 9728

114. S. Cahill, L. A. Evans and M. O'Brien, *Tetrahedron Letters*, **2007**, 48, 5683
115. K. R. Prasad and S. L. Gholap, *J. Org. Chem.* **2006**, 71, 9, 3643
116. J. E. McMurray, *Organic Chemistry (8th Edition), Chapter 9: Alkynes*, **2012**,
Published by Brooks Cole in Boston
117. E. C. Ashby, J. Lammele and H. M. Neumann, *Acc. Chem. Res.* **1974**, 7, 272
118. N. R. Easton, C. A. Lukach, V. B. Fish and P. N. Craig, *J. Am. Chem. Soc.*
1953, 75, 19, 4731
119. R. W. Layer, *Chem. Rev.* **1963**, 63, 5, 489
120. D. O. Cowan and H. S. Mosher, *J. Org. Chem.* **1962**, 27, 1, 1
121. H. Meerwein and R. Schmidt, *Eur. J. Org. Chem.* **1925**, 444, 1, 221
122. E. D. Williams, K. A. Krieger and A. R. Day, *J. Am. Chem. Soc.* **1953**, 75,
2404
123. L. K. Saraku-Neequaye, *Synthesis and Reactions of Sulfinimines*, **2010**, PhD
Thesis, University of East Anglia
124. R. Bloch, *Chem. Rev.* **1998**, 98, 1407
125. A. R. Katritzky, H. Lang, Z. Wang, Z. Zhang and H. Song, *J. Org. Chem.*
1995, 60, 7619
126. G. Stork and L. Maldonado, *J. Am. Chem. Soc.* **1971**, 93, 20, 5286
127. A. R. Baru and R. S. Mohan, *J. Chem. Edu.* **2005**, 82, 11, 1674
128. E. J. Corey and A. Venkateswarlu, *J. Am. Chem. Soc.* **1972**, 94, 17, 6190
129. P. L. Fuchs, *Handbook of Reagents for Organic Synthesis: Reagents for
Silicon-Mediated Organic Synthesis*, Page 641, **2011**, Published by John
Wiley & Sons in West Sussex
130. L. M. Harwood and J. Robertson, *Tetrahedron Letters*, **1987**, 28, 43, 5175
131. M. Orchin, *J. Chem. Edu.* **1989**, 66, 7, 586

132. P. R. Parry, *New Pyridylboronic Acids and their Cross-Coupling Reactions*, **2003**, PhD Thesis, University of Durham
133. H. Guo and G. A. O'Doherty, *Org. Lett.* **2006**, 8, 8, 1609
134. K. C. Nicolaou, K. P. Cole, M. O. Frederick, R. J. Aversa and R. M. Denton, *Angew. Chem. Int. Ed.* **2007**, 46, 8875
135. M. Gray, M. Tinki and V. Snieckus, *Comprehensive Organic Chemistry II. A Review of Literature 1982 – 1994. Volume 11 – Main-group Metal Organometallics in Organic Synthesis, Chapter 1 – Lithium*, Page 72, **1995**, Published by Elsevier Science Ltd. in Oxford
136. G. Desmoni, G. Faita, A. Galbiati, D. Pasni, P. Quadrelli and F. Rancati, *Tetrahedron: Asymmetry*, **2012**, 13, 333
137. P. J. Garegg and B. Samuelsson, *J. Chem. Soc. Perkin Trans. 1*, **1980**, 2866
138. X. Tang, J. An and R. M. Denton, *Tetrahedron Letters*, **2014**, 55, 799
139. D. Morrod and M. Rose, *The Molecular World: Mechanism and Synthesis, Chapter 2: Organomagnesium halides*, Page 83, **2002**, Published by The Open University in Milton Keynes
140. V. K. Ahluwalia and M. Goyal, *A Textbook of Organic Chemistry, Chapter 13: Organometallic Compounds, Section 13.1: Introduction*, **2000**, Published by Narosa Publishing House in New Delhi
141. L. Claisen and A. Claparède, *Ber. Dtsch. Chem. Ges.* **1881**, 14, 2460
142. J. G. Schmidt, *Ber. Dtsch. Chem. Ges.* **1881**, 14, 1459
143. K. S. Tewari and N. K. Vishnoi, *A Textbook of Organic Chemistry (3rd Edition)*, Page 648, **2006**, Published by Vilkas Publishing House in New Delhi
144. M. Braun, *Modern Aldol Reactions: Volume I: Enolates, Organocatalysts, Biocatalysts and Natural Product Synthesis, Chapter 1: Fundamentals and*

- Transition State Models. Aldol Additions of Group 1 and 2 Enolates*, Pages 1-2, **2004**, Published by Wiley-VCH in Germany
145. B. D. Mather, K. Viswanathan, K. M. Miller and T. E. Long, *Prog. Polym. Sci.* **2006**, 31, 487
146. R. G. Pearson, *J. Am. Chem. Soc.* **1963**, 85, 22, 3533
147. T. -L. Ho, *Chem. Rev.* **1975**, 75, 1, 1
148. V. Rosnati, A. Saba and A. Salimbeni, *Tetrahedron Letters*, **1981**, 22, 2, 167
149. G. -W. Wang, Y. Murata, K. Komatsu and T. S. M. Wan, *Chem. Commun.* **1996**, 2059
150. A. P. Krapcho, G. A. Glynn and B. J. Grenon, *Tetrahedron Letters*, **1967**, 8, 3, 215
151. A. P. Krapcho and A. L. Lovey, *Tetrahedron Letters*, **1973**, 14, 12, 957
152. P. S. Poon, A. K. Banerjee and M. S. Iyaya, *J. Chem. Res.* **2011**, 67
153. J. E. Johnson, R. H. Blizzard and H. W. Carhart, *J. Am. Chem. Soc.* **1948**, 70, 11, 3664
154. H. C. Brown and S. Krishnamurthy, *J. Org. Chem.* **1969**, 34, 12, 3918
155. M. S. Brown and H. Rapoport, *J. Org. Chem.* **1963**, 28, 3261
156. J. C. S. de Costa, K. C. Pais, E. L. Fernandes, P. S. M. de Oliveira, J. S. Mendonça, M. V. N. de Souza, M. A. Peralta and T. R. A. Vasconcelos, *Arkivoc*, **2006**, 128
157. M. T. Huggins and F. Billimora, *J. Chem. Edu.* **2007**, 84, 3, 471
158. P. H. J. Carlsen, T. Katsuki, V. S. Martin and K. B. Sharpless, *J. Org. Chem.* **1981**, 46, 3936

159. B. Figadère and X. Franck, *Science of Synthesis: Compounds with Four and Three Carbon-Heterocycle Bonds, Section 20.2.1.5.1.9.1 Variation 1*, **2014**, Published by Georg Thieme Verlag in Stuttgart
160. N. M. Yoon, C. S. Pah, H. C. Brown, S. Krishnamurthy and T. P. Stocky, *J. Org. Chem.* **1973**, 38, 16, 2786
161. M. C. Pirrung, *The Synthetic Organic Chemist's Companion*, **2007**, Published by John Wiley & Sons Inc. in New Jersey
162. N. G. Anderson, *Practical Process Research and Development: A Guide for Organic Chemists (2nd Edition)*, **2012**, Published by Academic Press in Oxford
163. C. Wang, X. Xie, J. Liu, Y. Liu and Y. Li, *Chem Eur. J.* **2015**, 21, 559
164. A. S. K. Hashmi, T. Häffney, W. Yang, S. Pankajakshan, S. Schäfer, L. Schultes, F. Rominger and W. Frey, *Chem. Eur. J.* **2012**, 18, 10480
165. T. Ehara, S. Tanikawa, M. Ono and H Akita, *Chem. Pharm. Bull.* **2007**, 55, 9, 1361
166. A. Struder, M. Bossart and T. Vasella, *Org. Lett.* **2000**, 2, 7, 985
167. M. Bossart, R. Fässler, J. Schoenberger and A. Struder, *Eur. J. Org. Chem.* **2002**, 2742
168. M. Colombo and I. Peretto, *Tomorrow's Chemistry Today: Concepts in Nanoscience, Organic Materials and Environmental Science*, Chapter 15, Page 367, **2009**, Published by Wiley-VCH Verlag GmbH & Co. in Weinheim
169. B. Gutmann, D. Cantillo and C. O. Kappe, *Angew. Chem. Int. Ed.* **2015**, 54, 23, 6688
170. S. G. Newman and K. F. Jensen, *Green Chem.* **2013**, 15, 6, 1456
171. M. Baumann and I. R. Baxendale, *Beilstein J. Org. Chem.* **2015**, 11, 1194

172. T. Kawaguchi, H. Miyata, K. Ataka, K. Mae and J. –I. Yoshida, *Angew. Chem. Int. Ed.* **2005**, 44, 2413
173. M. Brzozowski, M. O'Brien, S. V. Ley and A. Polyzos, *Acc. Chem. Res.* **2015**, 48, 349
174. T. W. Phillips, J. H. Bannock and J. C. deMello, *Lab. Chip.* **2015**, 15, 2960
175. M. O'Brien and D. Cooper, *Synlett.* **2016**, 27, 164
176. P. Vlasák and J. Mindl, *J. Chem. Soc. Perkin Trans. 2*, **1997**, 1401
177. R. He and Y. Lam, *Org. Biomol. Chem.* **2008**, 6, 2182
178. D. R. Dabideen, K. F. Cheng, B. Aljabari, E. J. Miller, V. A. Pavlov and Y. Al-Abed, *J. Med. Chem.* **2007**, 50, 8, 1993
179. J. D. Flores, J. Shi, C. E. Hoyle and C. L. McCormick, *Polym. Chem.* **2010**, 1, 213
180. M. O'Brien, P. Koos, D. L. Browne and S. V. Ley, *Org. Biomol. Chem.* **2012**, 10, 7031
181. I. Jirkovsky, *Can. J. Chem.* **1974**, 52, 1, 55
182. S. Gogoi, R. Bhuyan and N. C. Baura, *Synthetic Communications*, **2005**, 35, 2811
183. S. E. Denmark and M. T. Burk, *Proc. Natl. Acad. Sci. USA*, **2010**, 107, 48, 20655
184. Z. –G. Le, Z. –C. Chen and Y. Hu, *Chinese J. Chem.* **2005**, 23, 1537
185. B. J. Albert, A. Sivaramakrishnan, T. Naka and K. Koide, *J. Am. Chem. Soc.* **2006**, 128, 9, 2792
186. R. W. Bates and P. Song, *Tetrahedron*, **2007**, 63, 4497
187. D. H. R. Barton, J. Kervagoret and S. Z. Zard, *Tetrahedron*, **1990**, 46, 21, 7587

188. Y. Liu, X. Wang, X. Wang and W. He, *Org. Biomol. Chem.* **2014**, 12, 3163
189. P. A. Clarke and S. Santon, *Eur. J. Org. Chem.* **2006**, 2045

5. Experimental

5.1. General Experimental Information

Unless otherwise specified, all reagents were purchased from commercial suppliers (Sigma-Aldrich; Fisher Scientific – Fisher Chemical/Acros Organics; Alfa-Aesar; TCI; VWR Chemicals) and were used as received with no further purification.

Methanol was purchased from VWR Chemicals (UN1230 – 2.5 L). Ethanol was purchased from Fisher Chemical (E/0650DF/17 – 2.5 L). Dichloromethane was purchased from VWR Chemicals (UN1593 – 2.5 L). Toluene was purchased from Fisher Chemical (T/2300/17 – 2.5 L). Hexane was purchased from Sigma Aldrich (34859 – 2.5 L). Petroleum ether 40 - 60°C was purchased from Fisher Chemical (P/1440/17 – 2.5 L). Diethyl ether was purchased from Fisher Chemical (D/2400/17 – 2.5 L). Ethyl acetate was purchased from VWR Chemicals (UN1173 – 2.5 L). Acetonitrile was purchased from Sigma Aldrich (34851 – 2.5 L). Tetrahydrofuran was purchased from Fisher Chemical (T/0701/17 – 2.5 L). Anhydrous tetrahydrofuran was purchased from Acros Organics (3484 50010 – 1 L). Dimethyl sulfoxide was purchased from Alfa Aesar (A13280 – 500 g). Butan-1-ol was purchased from Acros Organics (1076 90025 – 2.5 L). Chloroform was purchased from Fisher Chemicals (C/4920/17 – 2.5 L). Anhydrous dimethylformamide was purchased from Acros Organics (3268 70010 – 1 L). Transfers of anhydrous solvents were always achieved using a positive pressure of nitrogen gas (balloon).

Reactions that were being conducted under an inert atmosphere were carried out using a positive pressure of dry nitrogen or argon gas (either through use of a balloon or through use of a manifold/bubbler apparatus) and glassware for these reactions was dried using a heat-gun under a constant flow of the respective gas. Grains of calcium hydride, when used in reactions as a desiccant, were obtained from freshly ground chunks of the material, which was stored in an airtight container under nitrogen.

Column chromatography was carried out using glass columns and compressed air at approximately 0.5 bar above ambient pressure. Silica gel used was purchased from Grace-Davison (Davisil LC60A 40-63 micron) or from Sigma Aldrich (Merck-9385 grade silica). Reactions were monitored by thin layer chromatography (TLC) and the TLC plates used were Merck Silica-Gel 60 F₂₅₄, aluminium backed, 1.005554.0001. Visualisation of the TLC plates was achieved using a vanillin dip, potassium permanganate dip, iodine vapour or through use of shortwave ultraviolet light (254 nm).

NMR spectroscopy was conducted on Bruker systems (300 MHz: Magnet – Bruker Spectrospin 300 MHz/52 mm, Spectrometer – Avance 300), (400 MHz: Magnet – Bruker Ascend 400, Spectrometer: Avance III 400). d-Chloroform was purchased from Cambridge Isotopes, Andover Massachusetts, USA (99.8% D, DLM-7TB-100) and was stored over granular anhydrous potassium carbonate (approximately 5 g was added to each bottle used). d₃-Acetonitrile was purchased from Apollo Scientific (98.8% D) or Cambridge Isotopes (99.8% D, DLM-21). d₄-Methanol was

purchased from Cambridge Isotopes (99.8% D, DLM-24-10). d_6 -Benzene was purchased from Sigma Aldrich (99.96% D, 241-061-8).

All NMR data is quoted in parts-per-million (ppm) relative to trimethylsilane (TMS) at 0 ppm. ^1H -NMR spectra were calibrated in reference to the residual H-solvent peak ($\text{CDCl}_3 = 7.26$ ppm, $\text{CD}_3\text{CN} = 1.94$ ppm – central peak of quintuplet, $\text{CD}_3\text{OD} = 3.31$ ppm – central peak of quintuplet, $\text{C}_6\text{D}_6 = 7.15$ ppm). ^{13}C -NMR spectra were calibrated in reference to the residual H-solvent peak ($\text{CDCl}_3 = 77.0$ ppm – central peak of triplet, $\text{CD}_3\text{CN} = 1.24$ ppm – central peak of septuplet, $\text{CD}_3\text{OD} = 49.05$ ppm, central peak of septuplet, $\text{C}_6\text{D}_6 = 128.02$ ppm – central peak of triplet).

Multiplicity is denoted by: d = doublet; t = triplet; q = quartet; m = multiplet; dd = double doublet; etc. Coupling constants (J values) are listed in Hertz (Hz) and are quoted with averaging between mutually coupling protons. Protons that are coupled to two other non-identical protons but with identical coupling constants are generally referred to as double doublets rather than triplets (or apparent triplets).

Assignment of peaks in the ^1H -NMR spectrum was conducted using chemical-shift values, coupling constants, correlation spectroscopy (COSY), total correlation spectroscopy (TOCSY), heteronuclear multiple bond correlation (HMBC) and heteronuclear single quantum correlation (HSQC). For diastereomeric mixtures, where possible, peaks corresponding to particular diastereomers are labeled and unless otherwise specified the stereochemistry of each diastereomer is unknown. Infrared spectroscopy was carried out using a thin film (evaporated from solution) on a Thermo Scientific Nicolet iS10 ATR spectrometer. Mass spectrometry was

carried out on a Waters LCMS with electrospray ionisation and a time-of-flight (TOF) analyser.

5.2. Data for Compounds Synthesised from the Azaspiroketal Synthesis

Synthesis of 2-methyl-1-tosylpiperidine (194)

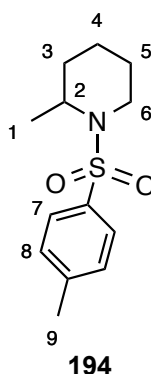

2-methylpiperidine (1.18 mL, 10.1 mmol, 1.00 eqv.) was dissolved in dichloromethane (20.0 mL). To this triethylamine (4.25 mL, 30.5 mmol, 3.02 eqv.) and 4-dimethylaminopyridine (65.8 mg, 0.539 mmol, 0.0539 eqv.) were added and the reaction mixture was cooled to 0°C. To this a solution of *p*-toluenesulfonyl chloride (2.96 g, 15.4 mmol, 1.52 eqv.) in dichloromethane (10.0 mL) was added dropwise over the course of one minute, whilst the reaction temperature was maintained at 0°C. After four hours the reaction had reached completion and 2M sodium hydroxide solution (20.0 mL) was added to convert the excess *p*-toluenesulfonyl chloride to *p*-toluenesulfonic acid. This was allowed to stir for a further 20 minutes. The organic material was washed with 2M sodium hydroxide solution (50.0 mL), water (50.0 mL), 2M hydrochloric acid (50.0 mL), water (50.0 mL) and finally brine (50.0 mL). The organic material was then dried over calcium carbonate before being dried under reduced pressure. The product crystallised giving cream crystals.

Yield: 97% (2.47 g, 9.75 mmol); $^1\text{H-NMR}$: (CDCl_3 , 300 MHz) δ 7.70 (J = 8.3 Hz, 2H, d, H-7), 7.27 (J = 8.3 Hz, 2H, d, H-8), 4.29 – 4.17 (1H, m, H-6^e), 3.72 – 3.67 (1H, m, H-2), 2.97 (J = 2.5, 12.8, 13.2 Hz, 1H, ddd, H-6^a), 2.41 (3H, s, H-9), 1.62 – 1.37 (6H, m, H-3, H-4 and H-5), 1.06 (J = 6.9 Hz, 3H, d, H-1); *Melting Point:* 55 – 56 °C (Literature Value: 55 °C); Data in accordance with literature values.¹

Synthesis of 4-methyl-1-tosylpiperidine (196)

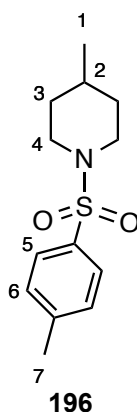

Experimental procedure followed that described for **194** using:

4-methylpiperidine (1.20 mL, 10.1 mmol, 1.00 eqv.); triethylamine (4.20 mL, 30.1 mmol, 2.98 eqv.); 4-dimethylaminopyridine (63.8 mg, 0.522 mmol, 0.0517 eqv.), *p*-toluenesulfonyl chloride (2.96 g, 15.4 mmol, 1.52 eqv.) and DCM (30.0 mL). The product crystallised giving a white solid.

Yield: 97% (2.51 g, 9.91 mmol); $^1\text{H-NMR}$: (CDCl_3 , 300 MHz) δ 7.63 (J = 8.3 Hz, 2H, d, H-5), 7.31 (J = 8.3 Hz, 2H, d, H-6), 3.73 (J = 11.3 Hz, 2H, d, H-4^e), 2.43 (3H, s, H-7), 2.23 – 2.19 (2H, m, H-4^a), 1.65 – 1.21 (5H, m, H-2 and H-3), 0.90 (J = 5.5 Hz, 3H, d, H-1); *Melting Point:* 83 – 84 °C; Data in accordance with literature values.¹

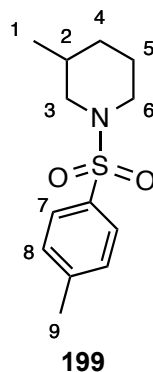
Synthesis of 3-methyl-1-tosylpiperidine (**199**)

Experimental procedure followed that described for **194** using:

3-methylpiperidine (1.19 mL, 10.2 mmol, 1.00 eqv.); triethylamine (4.25 mL, 30.5 mmol, 2.99 eqv.); 4-dimethylaminopyridine (79.6 mg, 0.652 mmol, 0.0639 eqv.), *p*-toluenesulfonyl chloride (2.96 g, 15.5 mmol, 1.52 eqv.) and DCM (30.0 mL). The product crystallised giving a cream solid.

Yield: 96% (2.48 g, 9.79 mmol); ¹H-NMR: (CDCl₃, 300 MHz) δ 7.63 (J = 8.2 Hz, 2H, d, H-7), 7.31 (J = 8.2 Hz, 2H, d, H-8), 3.67 – 3.58 (2H, m, H-3^e and H-6^e), 2.43 (3H, s, H-9), 2.18 (J = 3.1, 11.3, 11.4 Hz, 1H, ddd, H-6^a), 1.85 (J = 10.6, 10.6 Hz, 1H, dd, H-3^a), 1.82 – 1.52 (5H, m, H-2, H-4 and H-5), 0.86 (J = 6.3 Hz, 3H, d, H-1);

Melting Point: 110 – 111 °C (Literature Value: 110 °C); Data in accordance with literature values.²

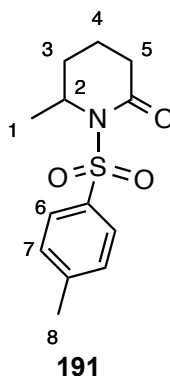
Synthesis of 6-methyl-1-tosylpiperidin-2-one (191)

2-methyl-1-tosylpiperidine (**194**) (1.02 g, 4.03 mmol, 1.00 eqv.) was dissolved in ethyl acetate (40.0 mL). Water (20.0 mL) was added to this and the biphasic mixture was rapidly stirred. Sodium periodate (4.22 g, 19.7 mmol, 4.89 eqv.) was added and, once dissolved, ruthenium (III) chloride hydrate (10.3 mg, 0.0497 mmol, 0.0123 eqv.) was added. After twelve hours the reaction had gone to completion and the aqueous phase was washed with ethyl acetate (2 × 50.0 mL). The combined organic phases were then washed with water (2 × 50.0 mL) and brine (100 mL) before being dried over magnesium sulfate and subsequently concentrated under reduced pressure. The crude material was then purified *via* column chromatography using a graduated solvent system reaching a 3:2 mixture of petroleum ether and ethyl acetate. The desired product was obtained as a colourless oil.

Yield: 33% (357 mg, 1.34 mmol); ¹H-NMR: (CDCl₃, 300 MHz) δ 7.90 (J = 8.3 Hz, 2H, d, H-6), 7.29 (J = 8.3 Hz, 2H, d, H-7), 4.83 – 4.72 (1H, m, H-2), 2.53 – 2.29 (5H, m, H-3^e, H-5^e and H-8), 1.99 – 1.76 (4H, m, H-3^a, H-4 and H-5^a), 1.47 (J = 6.6 Hz, 3H, d, H-1); Data in accordance with literature values.¹

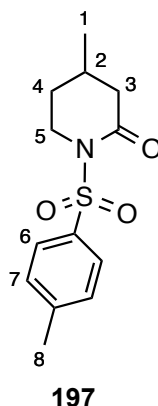
Synthesis of 4-methyl-1-tosylpiperidin-2-one (197)

Experimental procedure followed matched that described for **191** using:

4-methyl-1-tosylpiperidine (**196**) (0.998 g, 3.94 mmol, 1.00 eqv.); sodium periodate (4.30 g, 20.1 mmol, 5.10 eqv), ruthenium (III) chloride hydrate (13.7 mg, 0.0665 mmol, 0.0169 eqv.), water (10.0 mL) and ethyl acetate (35.0 mL). The desired product was obtained as a yellow/brown oil.

Yield: 45% (0.475 g, 1.78 mmol); $^1\text{H-NMR}$: (CDCl_3 , 300 MHz) δ 7.91 (J = 8.3 Hz, 2H, d, H-6), 7.31 (J = 8.3 Hz, 2H, d, H-7), 4.14 (J = 1.8, 4.7, 12.0 Hz, 1H, ddd, H-5^e), 3.27 (J = 10.3, 12.0 Hz, 1H, dd, H-5^a), 2.53 – 2.33 (5H, m, H-3^e, H-4^e and H-8), 2.08 – 1.93 (1H, m, H-3^a), 1.91 – 1.78 (1H, m, H-4^a), 1.50 – 1.34 (1H, m, H-2), 1.11 (J = 6.8 Hz, 3H, d, H-1); Data in accordance with literature values.¹

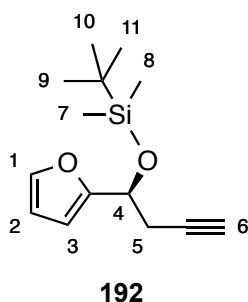
Alkyne 192

$^1\text{H-NMR}$ (300 MHz, CDCl_3): δ 7.36 (J = 1.8 Hz, 1H, d, H-1), 6.32 (J = 1.8, 3.2 Hz, 1H, dd, H-2), 6.26 (J = 3.2 Hz, 1H, d, H-3), 4.86 (J = 6.7 Hz, 1H, t, H-4), 2.70 (J = 2.6, 6.7 Hz, 2H, dd, H-5), 1.97 (J = 2.6 Hz, 1H, t, H-6), 0.89 (9H, s, H-9, H-10 and H-11), 0.11 (3H, s, Si-Me), -0.01 (3H, s, Si-Me);

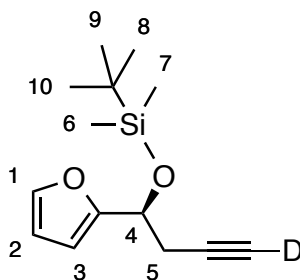

Alkyne **192** (0.330 g, 1.32 mmol, 1.00 eqv.) was dissolved in tetrahydrofuran (2.23 mL). The solution was cooled to -78°C . Once cooled, *n*-butyllithium solution (2.5 M in hexanes) (0.700 mL, 1.75 mmol, 1.33 eqv.) was added dropwise over the course of two minutes, and the solution was then stirred for 15 minutes. After this the solution was warmed to -15°C and stirred for a further 45 minutes. Deuterium oxide (0.250 mL, 13.8 mmol, 10.5 eqv.) was added and the solution was stirred for one hour whilst warming to room temperature. After this, the solution was diluted with ethyl acetate (25.0 mL) and water (25.0 mL). Extraction was performed using ethyl acetate (2×25.0 mL). The combined organic phases were then washed with water (2×50.0 mL) and brine (50.0 mL) before being dried over magnesium sulfate and concentrated under reduced pressure.

$^1\text{H-NMR}$ (300 MHz, CDCl_3): δ 7.36 (J = 1.8 Hz, 1H, d, H-1), 6.32 (J = 1.8, 3.2 Hz, 1H, dd, H-2), 6.25 (J = 3.2 Hz, 1H, d, H-3), 4.85 (J = 6.7 Hz, 1H, t, H-4), 2.69 (J =

2.6, 6.7 Hz, 2H, dd, H-5), 0.88 (9H, s, H-8, H-9 and H-10), 0.10 (3H, s, Si-Me), -
0.02 (3H, s, Si-Me)

5.3. Data from Organometallic Coupling Partner Synthesis

Synthesis of 1-(ethoxy(5-methylfuran-2-yl)methyl)-1H-benzo[d][1,2,3]triazole (225)

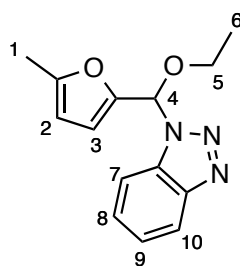

225

5-methylfurfural (**222**) (2.00 mL, 20.1 mmol, 1.00 eqv.) was dissolved in THF (30.0 mL). To this was added benzotriazole (**223**) (6.23 g, 52.3 mmol, 2.59 eqv.), ethanol (2.40 mL, 41.1 mmol, 2.04 eqv.), triethyl orthoformate (**224**) (10.0 mL, 60.1 mmol, 2.99 eqv.) and sulfuric acid (30.0 μ L, 0.563 mmol, 0.0280 eqv.). This formed a creamy precipitate that dissolved upon stirring. The reaction mixture was stirred at reflux for 36 hours. After this, the reaction mixture was diluted with diethyl ether (100 mL) and water (100 mL). Extraction was completed with diethyl ether (3 \times 30.0 mL). The combined organic phases were washed with saturated sodium bicarbonate solution (2 \times 100 mL) and water (100 mL) before being dried over magnesium sulfate and subsequently being concentrated under reduced pressure. The crude material was dissolved in petroleum ether (500 mL) and diethyl ether (50.0 mL). This resulted in the precipitation of excess benzotriazole and hence this was filtered and removed from the solution. The product was a yellow oil.

Yield: 61% (3.14 g, 12.2 mmol); $^1\text{H-NMR}$: (CDCl_3 , 300 MHz) δ 8.07 – 8.04 (1H, m, H-10), 7.63 (J = 8.1 Hz, 1H, d, H-7), 7.44 – 7.33 (2H, m, H-8 and H-9), 7.11 (1H, s, H-4), 6.36 (J = 3.1 Hz, 1H, d, H-3), 5.95 (J = 3.1 Hz, 1H, dd, H-2), 3.78 – 3.65 (1H, m, H-5), 3.47 – 3.36 (1H, m, H-5'), 2.20 (3H, s, H-1), 1.19 (J = 7.0 Hz, 3H, t, H-6); Data in accordance with literature values.³

Synthesis of 4-bromo-1-(5-methylfuran-2-yl)butan-1-one (**229**)

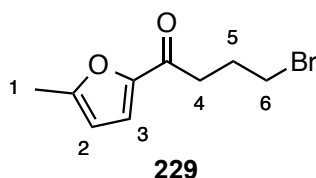

1-(ethoxy(5-methylfuran-2-yl)methyl)-1*H*-benzo[*d*][1,2,3]triazole (**225**) (0.682 g, 2.64 mmol, 1.00 eqv.) was dissolved in THF (15.0 mL) and the solution was cooled to -78°C . To this was added 1,3-dibromopropane (**227**) (0.410 mL, 4.04 mmol, 1.53 eqv.) and 2.5 M *n*-butyl lithium solution (1.60 mL, 4.00 mmol, 1.52 eqv.). The reaction was kept below 0°C and stirred for 2.5 hours. Once complete the reaction was quenched by adding water (5.00 mL) dropwise over the course of five minutes. The reaction mixture was then diluted with diethyl ether (150 mL) and washed with saturated sodium bicarbonate solution (2×100 mL) and water (100 mL), before being dried over magnesium sulfate and subsequently being concentrated under reduced pressure. The crude material (**228**) was then dissolved in THF (10.0 mL) and water (2.50 mL) and a catalytic quantity of polymer-supported sulfonic acid was added. The reaction was gently stirred for three hours. Upon completion, the acid was filtered off and washed with THF (2×10.0 mL). The combined organic material was then concentrated under reduced

pressure before being dissolved in petroleum ether (100 mL). This was washed with saturated sodium bicarbonate solution (2 × 100 mL) and water (100 mL) before being dried over magnesium sulfate and subsequently being concentrated under reduced pressure. The crude product was then purified by column chromatography using a graduated solvent system reaching a 9:1 mixture of petroleum ether and ethyl acetate. The product was a yellow oil.

Yield: 45% over 2 steps (277 mg, 1.20 mmol); ¹H-NMR: (CDCl₃, 300 MHz) δ 7.13 (J = 3.5 Hz, 1H, d, H-3), 6.15 (J = 3.5 Hz, 1H, d, H-2), 3.50 (J = 6.4 Hz, 2H, t, H-6), 2.96 (J = 7.1 Hz, 2H, t, H-4), 2.38 (3H, s, H-1), 2.30 – 2.21 (2H, m, H-5); Data in accordance with literature values.⁴

Synthesis of 4-bromo-1-(5-methylfuran-2-yl)butan-1-ol (236)

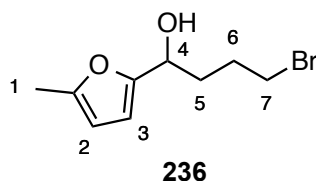

4-bromo-1-(5-methylfuran-2-yl)butan-1-one (**229**) (49.0 mg, 0.212 mmol, 1.00 eqv.) was dissolved in methanol (5.00 mL) under an inert atmosphere. The reaction mixture was cooled to 0°C and sodium borohydride (24.3 mg, 0.642 mmol, 3.03 eqv.) was added. The reaction was stirred for two hours and allowed to warm to room temperature during this time. The reaction was then quenched by the dropwise addition of water (5.00 mL) over the course of two minutes. After this the reaction mixture was diluted with ethyl acetate (50.0 mL) and water (50.0 mL). Extraction was completed using ethyl acetate (2 × 25.0 mL). The combined

organic phases were washed with saturated sodium bicarbonate solution (2 × 50.0 mL) and water (50.0 mL) before being dried over magnesium sulfate and subsequently concentrated under reduced pressure. The product was a pale yellow oil.

Yield: 33% (16.4 mg, 0.0704 mmol); *¹H-NMR:* (CDCl₃, 300 MHz) δ 6.12 (J = 3.1 Hz, 1H, d, H-3), 5.90 (J = 0.9, 3.1 Hz, 1H, dd, H-2), 4.64 (J = 5.9 Hz, 1H, t, H-4), 3.45 (J = 5.5, 6.6 Hz, 2H, dd, H-7), 2.28 (J = 0.9 Hz, 3H, d, H-1), 2.04 – 1.90 (4H, m, H-5 and H-6); Data in accordance with literature values.⁴

Synthesis of (4-bromo-1-(5-methylfuran-2-yl)butoxy)(tert-butyl)dimethylsilane (**237**)

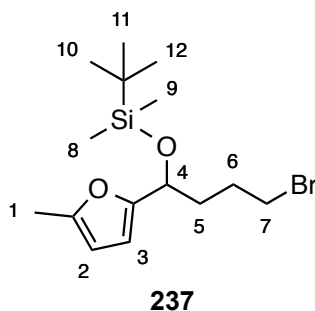

4-bromo-1-(5-methylfuran-2-yl)butan-1-ol (**236**) (69.9 mg, 0.300 mmol, 1.00 eqv.) was dissolved in THF (5.00 mL). Imidazole (**230**) (248 mg, 3.64 mmol, 12.1 eqv.) and *tert*-butyldimethylsilyl chloride (**231**) (192 mg, 1.27 mmol, 4.23 eqv.) were added and the reaction mixture was stirred at room temperature for seven hours. The reaction was then diluted by adding water (20.0 mL). Extraction was achieved with diethyl ether (3 × 50.0 mL). The combined organic phases were washed with saturated sodium bicarbonate solution (50.0 mL), water (50.0 mL) and brine (50.0 mL) before being dried over magnesium sulfate and subsequently being

concentrated under reduced pressure. The product was purified by column chromatography using a graduated solvent system reaching a 7:3 mixture of petroleum ether and ethyl acetate. The pure product obtained was a pale yellow oil.

Yield: 22% (22.6 mg, 0.0651 mmol); $^1\text{H-NMR}$: (CDCl_3 , 300 MHz) δ 6.04 (J = 3.0 Hz, 1H, d, H-3), 5.87 (J = 3.0 Hz, 1H, d, H-2), 4.65 (J = 5.8 Hz, 1H, t, H-4), 3.42 (J = 3.8, 6.7 Hz, 2H, dd, H-7), 2.27 (3H, s, H-1), 2.02 – 1.85 (4H, m, H-5 and H-6), 0.88 (9H, s, H-10, H-11 and H-12), 0.05 (3H, s, Si-Me), -0.07 (3H, s, Si-Me); $^{13}\text{C-NMR}$: (CDCl_3 , 75 MHz) δ 154.7, 151.0, 106.7, 105.8, 67.8, 35.3, 33.8, 30.3, 28.9, 25.8, 18.2, 13.5, -4.9, -5.1; *IR*: $\bar{\nu}$ 2957, 2928, 2857, 1463, 1361, 1254, 1221, 1079, 1039, 1020, 1004, 834, 775, 442, 423; R_f (9:1 petroleum ether : ethyl acetate) 0.65; *Mass Spectrometry*: Decomposed rapidly – accurate mass unable to be obtained.

Synthesis of 4-hydroxy-4-(5-methylfuran-2-yl)butyl benzoate (250)

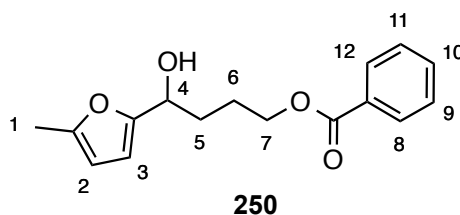

2-methylfuran (**245**) (10.5 mL, 117.5 mmol, 2.00 eqv.) was dissolved in THF (100 mL) and cooled to -10°C . *n*-butyl lithium solution (23.5 mL, 58.8 mmol, 1.00 eqv.) was added and the reaction mixture was stirred for one hour at this temperature. Independently γ -butyrolactone (**246**) (5.00 mL, 65.0 mmol, 1.11 eqv.) was dissolved in THF (100 mL) and both reaction vessels were cooled to -78°C . Using

a cannula the lithiated species was transferred to the γ -butyrolactone solution. The reaction was allowed to warm to room temperature and was stirred at this temperature for 15 hours. The mixture was then diluted with diethyl ether (50.0 mL) and water (50.0 mL). Extraction was accomplished using diethyl ether (3 \times 50.0 mL) and the combined organic phases were then washed with water (2 \times 100 mL) and brine (100 mL). The organic phase was then dried over magnesium sulfate and concentrated under reduced pressure. The crude material (4.50 g, 26.8 mmol, 1.00 eqv.) was dissolved in dichloromethane (50.0 mL) under an inert atmosphere. 4-dimethylaminopyridine (10.5 g, 85.6 mmol, 3.19 eqv.) was added and the reaction cooled to -15°C before the addition of benzoyl chloride (3.80 mL, 32.7 mmol, 1.22 eqv.). This was stirred at -15°C for five minutes. The reaction mixture was then diluted with diethyl ether (60.0 mL) and water (60.0 mL). Extraction was achieved with diethyl ether (3 \times 50.0 mL). Subsequently the combined organic phases were washed with saturated sodium bicarbonate solution (2 \times 100 mL) and saturated ammonium chloride solution (2 \times 100 mL) before being dried over magnesium sulfate and then being concentrated under reduced pressure. The crude material (5.80 g, 21.3 mmol, 1.00 eqv.) was dissolved in methanol (100 mL) and cooled to -15°C . Gradually sodium borohydride (2.49 g, 65.8 mmol, 3.09 eqv.) was added over the course of five minutes. The reaction was stirred for 40 minutes and during this time the reaction was allowed to warm to room temperature. The reaction mixture was concentrated to a volume of approximately 10.0 mL before being diluted with ethyl acetate (100 mL) and water (100 mL). Extraction was completed using ethyl acetate (3 \times 60.0 mL) and the combined organic phases were washed with brine (2 \times 100 mL). The organic phase was then dried over magnesium sulfate and subsequently

concentrated under reduced pressure. The product was purified using column chromatography using a graduated solvent system reaching a 1:1 mixture of petroleum ether and diethyl ether. The pure product was an orange oil.

Yield: 16% over 3 steps (2.62 g, 9.55 mmol); $^1\text{H-NMR}$: (CDCl_3 , 300 MHz) δ 8.04 ($J = 1.5, 7.6$ Hz, 2H, td, H-8 and H-12), 7.58 – 7.52 (1H, m, H-10), 7.42 ($J = 1.5, 7.6$ Hz, 2H, td, H-9 and H-11), 6.12 ($J = 3.1$ Hz, 1H, d, H-3), 5.89 ($J = 0.9, 3.1$ Hz, 1H, dd, H-2), 4.68 ($J = 6.3$ Hz, 1H, t, H-4), 4.35 ($J = 6.3$ Hz, 2H, t, H-7), 2.26 ($J = 0.9$ Hz, 3H, d, H-1), 2.04 – 1.76 (4H, m, H-5 and H-6); $^{13}\text{C-NMR}$: (CDCl_3 , 75 MHz) δ 166.6, 154.5, 151.7, 132.8, 130.2, 129.5, 128.3, 106.8, 106.0, 67.3, 64.6, 31.8, 25.0, 13.5; *IR*: $\bar{\nu}$ 3420 (O-H), 2954, 2922, 1714 (C=O), 1451, 1385, 1315, 1271, 1219, 1176, 1116, 1070, 1024, 998, 950, 933, 785, 709, 687; R_f (7:3 petroleum ether : diethyl ether): 0.32; *Mass Spectrometry*: TOF ES^+ : MNa^+ : Expected: m/z 297.1103, Observed: m/z 297,1093, Difference = 3.37 ppm

Synthesis of 4-methoxy-4-(5-methylfuran-2-yl)butyl benzoate (251)

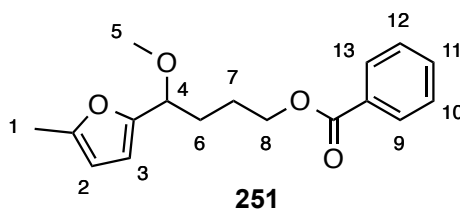

4-hydroxy-4-(5-methylfuran-2-yl)butyl benzoate (**250**) (2.50 g, 9.11 mmol) was dissolved in methanol (50.0 mL). To this solution was added Quadrapure™ polymer-supported sulfonic acid (0.353 g). The reaction was gently stirred for twelve hours. After, the reaction was filtered and the polymer beads washed with

methanol (3 × 10.0 mL). The organic solution was then concentrated under reduced pressure. The product was an orange/brown oil.

Yield: 96% (2.52 g, 8.74 mmol); ¹H-NMR: (CDCl₃, 300 MHz) δ 8.04 (J = 1.3, 7.6 Hz, 2H, td, H-9 and H-13), 7.58 – 7.52 (1H, m, H-11), 7.43 (J = 1.3, 7.6 Hz, 2H, td, H-10 and H-12), 6.16 (J = 3.0 Hz, 1H, d, H-3), 5.91 (J = 0.9, 3.0 Hz, 1H, dd, H-2), 4.33 (J = 6.3 Hz, 2H, t, H-4), 4.14 (J = 6.8 Hz, 1H, t, H-8), 3.26 (3H, s, H-5), 2.28 (J = 0.9 Hz, 3H, d, H-1), 2.08 – 1.70 (4H, m, H-6 and H-7); ¹³C-NMR: (CDCl₃, 75 MHz) δ 166.6, 152.1, 151.7, 132.8, 130.3, 129.5, 128.3, 109.2, 105.8, 76.1, 64.6, 56.2, 30.5, 25.1, 13.6; *IR:* $\bar{\nu}$ 2924, 2821, 1715 (C=O), 1451, 1314, 1270, 1176, 1110, 1070, 1025, 928, 785, 709, 687, 675; *R_f* (1:1 petroleum ether : diethyl ether): 0.80; *Mass Spectrometry:* TOF ES⁺: MNa⁺: Expected: *m/z* 311.1259, Observed: *m/z* 311.1232, Difference = 8.68 ppm

Synthesis of 4-methoxy-4-(5-methylfuran-2-yl)butan-1-ol (**243**)

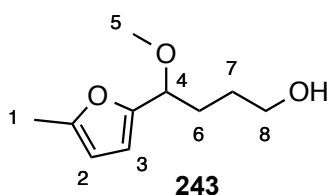

4-methoxy-4-(5-methylfuran-2-yl)butyl benzoate (**251**) (1.90 g, 6.59 mmol) was dissolved in THF (24.0 mL). To this was added methanol (10.0 mL) and 20% sodium hydroxide (6.00 mL). The reaction mixture was rapidly stirred for one hour. After this the reaction mixture was diluted with diethyl ether (100 mL) and water (100 mL). Extraction was completed using diethyl ether (4 × 40.0 mL). The combined organic phases were washed with brine (3 × 100 mL) before being dried

over magnesium sulfate and subsequently concentrated under reduced pressure. The final product was an amber oil.

Yield: >99% (1.21 g, 6.57 mmol); $^1\text{H-NMR}$: (CDCl_3 , 300 MHz) δ 6.13 (J = 3.1 Hz, 1H, d, H-3), 5.89 (J = 1.0, 3.1 Hz, 1H, dd, H-2), 4.10 (J = 6.0, 7.6 Hz, 1H, dd, H-4), 3.62 (J = 6.3 Hz, 2H, t, H-8), 3.24 (3H, s, H-5), 2.26 (J = 1.0 Hz, 3H, d, H-1), 2.02 – 1.80 (2H, m, H-6), 1.72 – 1.53 (2H, m, H-7); $^{13}\text{C-NMR}$: (CDCl_3 , 75 MHz) δ 152.9, 152.0, 152.0, 151.9, 108.9, 107.6, 105.9, 105.7, 73.9, 68.0, 67.9, 62.5, 56.1, 50.6, 30.7, 30.0, 29.1, 25.9, 25.5, 13.5; *IR*: $\bar{\nu}$ 3390 (O-H), 2924, 2871, 2821, 1561, 1449, 1327, 1220, 1109, 1062, 1019, 964, 930, 783, 554, 466; *R_f* (1:1 petroleum ether : diethyl ether): 0.31; *Mass Spectrometry*: TOF ES⁺: MNa⁺: Expected: *m/z* 207.0997, Observed: *m/z* 207.0992, Difference = 2.41 ppm

Synthesis of 2-(4-iodo-1-methoxybutyl)-5-methylfuran (**242**)

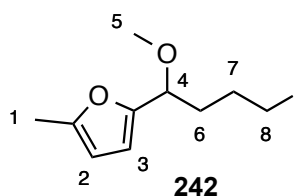

Triphenyl phosphine (**252**) (6.90 g, 26.3 mmol, 4.04 eqv.) was dissolved in dichloromethane (75.0 mL) under an inert atmosphere. To this was added imidazole (**230**) (4.61 g, 67.7 mmol, 10.4 eqv.) and iodine (2.45 g, 9.65 mmol, 1.48 eqv.) and the mixture was stirred at room temperature for five minutes. The reaction mixture was then cooled to -15°C and a solution of 4-methoxy-4-(5-methylfuran-2-yl)butan-1-ol (**243**) (1.20 g, 6.51 mmol, 1.00 eqv.) in dichloromethane (75.0 mL) was added dropwise over the course of three minutes.

The reaction was stirred for two hours, whilst being allowed to warm to room temperature. After, the mixture was diluted with water (100 mL) and diethyl ether (100 mL). Extraction was achieved with diethyl ether (4 × 50.0 mL). The combined organic phases were then washed with brine (2 × 100 mL), 30% hydrogen peroxide (2 × 50.0 mL), water (5 × 100 mL) and brine (100 mL) before being dried over magnesium sulfate. Once dried the organic solution was concentrated under reduced pressure. The product was purified *via* column chromatography using a graduated solvent system reaching a 1:1 mixture of petroleum ether and dichloromethane. The product was a yellow tinted oil.

Yield: 57% (1.09 g, 3.71 mmol); *¹H-NMR:* (CDCl₃, 300 MHz) δ 6.14 (J = 3.1 Hz, 1H, d, H-3), 5.90 (J = 0.7, 3.1 Hz, 1H, dd, H-2), 4.08 (J = 6.5 Hz, 1H, t, H-4), 3.28 (3H, s, H-5), 3.17 (J = 6.2 Hz, 2H, t, H-8), 2.28 (J = 0.7 Hz, 3H, d, H-1), 2.02 – 1.77 (4H, m, H-6 and H-7); *¹³C-NMR:* (CDCl₃, 75 MHz) δ 152.1, 151.7, 151.6, 150.8, 125.3, 120.7, 109.1, 108.5, 107.2, 105.8, 75.4, 56.1, 36.9, 34.7, 29.8, 13.6, 13.6, 6.5, 4.9; *R_f* (diethyl ether): 0.91; *Mass Spectrometry:* Decomposed rapidly – accurate mass unable to be obtained.

5.4. Data for Compounds Synthesised in the Formation of 2,4-Disubstituted Tetrahydropyrans

Synthesis of (E)-3-(4-bromophenyl)-1-(furan-2-yl)prop-2-en-1-one (272f)

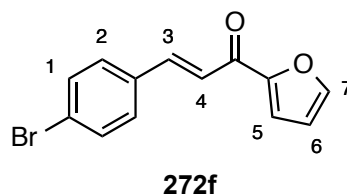

2-acetylfuran (**274**) (10.7 g, 97.2 mmol, 1.05 eqv.) was dissolved in methanol (100 mL). 4-bromobenzaldehyde (17.1 g, 92.5 mmol, 1.00 eqv.) was added, along with 5% aqueous sodium hydroxide solution (25.0 mL). This caused a precipitate to begin forming. This was stirred for 15 hours. After, the reaction was added to ice cold water (300 mL). This was then filtered under reduced pressure and the product recrystallised using ethanol. The product was a pale yellow crystalline solid.

Yield: 95% (24.3 g, 87.7 mmol); $^1\text{H-NMR}$ (CDCl_3 , 300 MHz): δ 7.79 (J = 15.8 Hz, 1H, d, H-3), 7.66 (J = 1.7 Hz, 1H, d, H-7), 7.55 – 7.49 (4H, m, H-1 and H-2), 7.43 (J = 15.8 Hz, 1H, d, H-4), 7.34 (J = 3.6 Hz, 1H, d, H-5), 6.60 (J = 1.7, 3.6 Hz, 1H, dd, H-6); *Melting Point:* 132 – 133 °C (Literature Value: 132 °C); Data in accordance with literature values.⁵

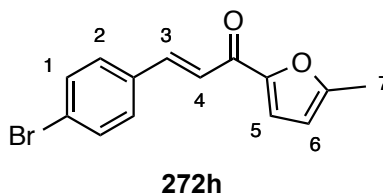
Synthesis of (E)-3-(4-bromophenyl)-1-(5-methylfuran-2-yl)prop-2-en-1-one (272h)

Experimental procedure followed matched that described for **272f** using:

5-methyl-2-acetylfuran (**275**) (0.480 mL, 4.12 mmol, 1.00 eqv.), 4-bromobenzaldehyde (0.978 g, 5.29 mmol, 1.28 eqv.), methanol (10.0 mL) and 5% aqueous sodium hydroxide solution (5.00 mL). The product was a pale yellow crystalline solid.

Yield: 80% (0.965 g, 3.31 mmol); $^1\text{H-NMR}$ (CDCl_3 , 300 MHz): δ 7.77 (J = 15.8 Hz, 1H, d, H-3), 7.56 – 7.49 (4H, m, H-1 and H-2), 7.37 (J = 15.8 Hz, 1H, d, H-4), 7.27 (J = 2.6 Hz, 1H, d, H-5), 6.23 (J = 2.6 Hz, 1H, d, H-6), 2.45 (3H, s, H-7); *Melting Point:* 159 °C (Literature Value: 159 °C); Data in accordance with literature values.⁶

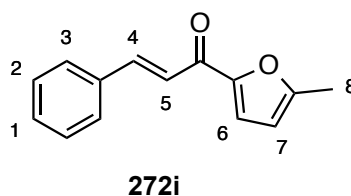
Synthesis of (E)-1-(5-methylfuran-2-yl)-3-phenylprop-2-en-1-one (272i)

Experimental procedure followed matched that described for **272f** using:

5-methyl-2-acetylfuran (**275**) (0.940 mL, 8.07 mmol, 1.00 eqv.), benzaldehyde (0.820 mL, 8.07 mmol, 1.00 eqv.), methanol (10.0 mL) and 5% aqueous sodium hydroxide solution (0.500 mL). The product was a pale yellow crystalline solid.

Yield: 71% (1.21 g, 5.70 mmol); $^1\text{H-NMR}$ (CDCl_3 , 300 MHz): δ 7.86 (J = 15.8 Hz, 1H, d, H-4), 7.69 – 7.61 (2H, m, H-3), 7.42 – 7.40 (3H, m, H-1 and H-2), 7.39 (J = 15.8 Hz, 1H, d, H-5), 7.28 (J = 4.0 Hz, 1H, d, H-6), 6.23 (J = 4.0 Hz, 1H, d, H-7), 2.45 (3H, s, H-8); *Melting Point:* 112 °C (Literature Value: 112 – 113 °C); Data in accordance with literature values.⁷

Synthesis of (E)-1-(5-methylfuran-2-yl)-3-p-tolylprop-2-en-1-one (**272j**)

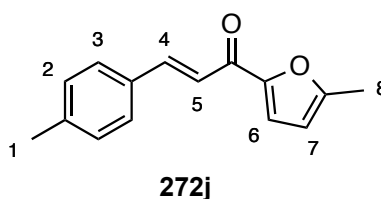

Experimental procedure followed matched that described for **272f** using:

5-methyl-2-acetylfuran (**274**) (0.940 mL, 8.07 mmol, 1.00 eqv.), *p*-tolualdehyde (0.950 mL, 8.06 mmol, 0.999 eqv.), methanol (10.0 mL) and 5% aqueous sodium hydroxide solution (0.500 mL). The product a yellow crystalline material.

Yield: 71% (1.29 g, 5.70 mmol); $^1\text{H-NMR}$ (CDCl_3 , 300 MHz): δ 7.83 (J = 15.8 Hz, 1H, d, H-4), 7.54 (J = 8.0 Hz, 2H, d, H-3), 7.34 (J = 15.8 Hz, 1H, d, H-5), 7.24 (J = 3.5 Hz, 1H, d, H-6), 7.22 (J = 8.0 Hz, 2H, d, H-2), 6.21 (J = 3.5 Hz, 1H, d, H-7), 2.44 (3H, s, H-8), 2.39 (3H, s, H-1); *Melting Point:* 133 – 134 °C; R_f (dichloromethane) 0.45; Data in accordance with literature values.⁸

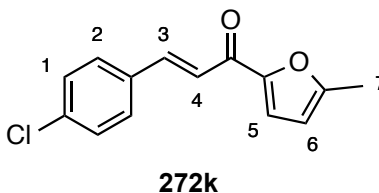
Synthesis of (E)-3-(4-chlorophenyl)-1-(5-methylfuran-2-yl)prop-2-en-1-one (272k)

Experimental procedure followed matched that described for **272f** using:

5-methyl-2-acetylfuran (**275**) (0.940 mL, 8.07 mmol, 1.00 eqv.), 4-chlorobenzaldehyde (1.23 g, 8.75 mmol, 1.08 eqv.), methanol (10.0 mL) and 5% aqueous sodium hydroxide solution (0.500 mL). The product was a pale yellow powder.

Yield: 85% (1.69 g, 6.85 mmol); ¹H-NMR (CDCl₃, 300 MHz): δ 7.76 (J = 15.8 Hz, 1H, d, H-3), 7.58 (J = 8.5 Hz, 2H, d, Ar-H), 7.35 (J = 15.8 Hz, 1H, d, H-4), 7.40 – 7.34 (2H, m, Ar-H), 7.27 – 7.25 (1H, m, H-5), 6.23 (J = 3.5 Hz, 1H, d, H-6), 2.45 (3H, s, H-7); *Melting Point:* 155 °C (Literature Value: 151 °C); Data in accordance with literature values.⁶

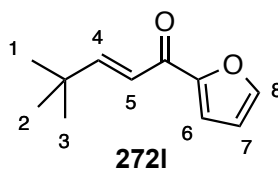
Synthesis of (E)-1-(furan-2-yl)-4,4-dimethylpent-2-en-1-one (272l)

Experimental procedure followed matched that described for **272f** using:

2-acetylfuran (**274**) (0.663 g, 6.02 mmol, 1.00 eqv.), trimethylacetylaldehyde (0.650 mL, 5.98 mmol, 0.993 eqv.), methanol (10.0 mL) and 5% aqueous sodium hydroxide solution (1.00 mL). The product was a brown oil.

Yield: 20% (0.213 g, 1.20 mmol); $^1\text{H-NMR}$ (CDCl_3 , 300 MHz): δ 7.59 (J = 1.5 Hz, 1H, d, H-8), 7.21 (J = 3.6 Hz, 1H, d, H-6), 7.12 (J = 15.7 Hz, 1H, d, H-4), 6.67 (J = 15.7 Hz, 1H, d, H-5), 6.52 (J = 1.5, 3.6 Hz, 1H, dd, H-7), 1.10 (9H, s, H-1, H-2 and H-3); Data in accordance with literature values.⁹

Synthesis of (E)-1,3-di(furan-2-yl)prop-2-en-1-one (272m)

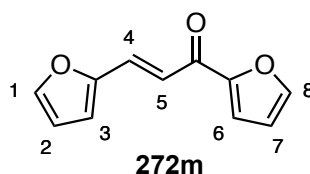

Experimental procedure followed matched that described for **272f** using:

2-acetylfuran (**274**) (0.545 g, 4.95 mmol, 1.08 eqv.), furaldehyde (0.380 mL, 4.59 mmol, 1.00 eqv.), methanol (10.0 mL) and 5% aqueous sodium hydroxide solution (2.00 mL). The product was a cream coloured crystalline solid.

Yield: 15% (0.128 g, 0.680 mmol); $^1\text{H-NMR}$ (CDCl_3 , 300 MHz): δ 7.65 (J = 1.4 Hz, 1H, d, H-8), 7.63 (J = 14.6 Hz, 1H, d, H-4), 7.53 (J = 1.6 Hz, 1H, d, H-1), 7.32 (J = 14.6 Hz, 1H, d, H-5), 7.31 (J = 3.6 Hz, 1H, d, H-6), 6.73 (J = 3.4 Hz, 1H, d, H-3), 6.59 (J = 1.4, 3.6 Hz, 1H, dd, H-7), 6.52 (J = 1.6, 3.4 Hz, 1H, dd, H-2); *Melting Point:* 87 °C (Literature Value: 85 – 86 °C); Data in accordance with literature values.¹⁰

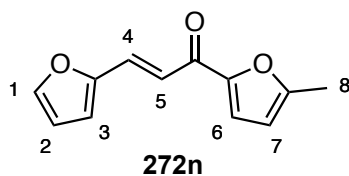
Synthesis of (E)-3-(furan-2-yl)-1-(5-methylfuran-2-yl)prop-2-en-1-one (272n)

Experimental procedure followed matched that described for **272f** using:

5-methyl-2-acetylfuran (**275**) (0.470 mL, 3.97 mmol, 1.00 eqv.), furaldehyde (0.350 mL, 4.23 mmol, 1.07 eqv.), methanol (10.0 mL) and 5% aqueous sodium hydroxide solution (2.00 mL). The product a yellow crystalline material.

Yield: 51% (0.412 g, 2.04 mmol); $^1\text{H-NMR}$ (CDCl_3 , 300 MHz): δ 7.58 (J = 15.5 Hz, 1H, d, H-4), 7.50 (J = 1.2 Hz, 1H, d, H-1), 7.24 (J = 15.5 Hz, 1H, d, H-5), 7.22 (J = 3.4 Hz, 1H, d, H-6), 6.67 (J = 3.5 Hz, 1H, d, H-3), 6.48 (J = 3.4 Hz, 1H, d, H-7), 6.19 (J = 1.2, 3.5 Hz, 1H, dd, H-2), 2.41 (3H, s, H-8); *Melting Point:* 80 – 81 °C; R_f (dichloromethane) 0.57; Data in accordance with literature values.⁷

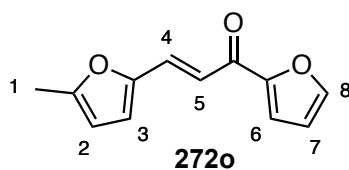
Synthesis of (E)-1-(furan-2-yl)-3-(5-methylfuran-2-yl)prop-2-en-1-one (272o)¹¹

Experimental procedure followed matched that described for **272f** using:

2-acetylfuran (**274**) (0.533 g, 4.84 mmol, 1.05 eqv.), 5-methyl-2-furaldehyde (0.460 mL, 4.62 mmol, 1.00 eqv.), methanol (10.0 mL) and 5% aqueous sodium hydroxide solution (2.00 mL). The product was a pale yellow crystalline solid.

Yield: 62% (0.579 g, 2.86 mmol); $^1\text{H-NMR}$ (CDCl_3 , 300 MHz): δ 7.64 (J = 1.7 Hz, 1H, d, H-8), 7.57 (J = 15.8 Hz, 1H, d, H-4), 7.30 (J = 3.6 Hz, 1H, d, H-6), 7.23 (J = 15.8 Hz, 1H, d, H-5), 6.63 (J = 3.3 Hz, 1H, d, H-3), 6.57 (J = 1.7, 3.6 Hz, 1H, dd, H-7), 6.13 (J = 3.3 Hz, 1H, d, H-2), 2.39 (3H, s, H-1); *Melting Point:* 68 – 69 °C (Literature Value: 69 – 70 °C); Data in accordance with literature values.¹¹

Synthesis of (E)-1,3-bis(5-methylfuran-2-yl)prop-2-en-1-one (272p)

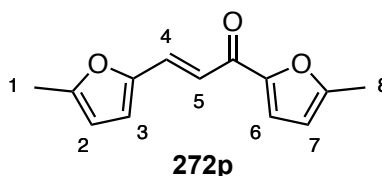

Experimental procedure followed matched that described for **272f** using:

5-methyl-2-acetylfuran (**275**) (0.480 mL, 4.06 mmol, 1.00 eqv.), 5-methyl-2-furaldehyde (0.410 mL, 4.12 mmol, 1.01 eqv.), methanol (10.0 mL) and 5% aqueous sodium hydroxide solution (2.00 mL). The product was a red/brown oil.

Yield: 62% (0.547 g, 2.53 mmol); $^1\text{H-NMR}$ (CDCl_3 , 300 MHz): δ 7.52 (J = 15.4 Hz, 1H, d, H-4), 7.21 (J = 3.4 Hz, 1H, d, H-6), 7.15 (J = 15.4 Hz, 1H, d, H-5), 6.58 (J = 3.3 Hz, 1H, d, H-3), 6.18 (J = 3.4 Hz, 1H, d, H-7), 6.10 (J = 3.3 Hz, 1H, d, H-2), 2.42 (3H, s, H-8), 2.37 (3H, s, H-1); $^{13}\text{C-NMR}$ (CDCl_3 , 75 MHz): δ 177.1 (C=O), 157.9, 155.7, 152.5, 150.2, 129.4, 119.1, 118.0, 117.1, 109.3, 109.1, 14.1, 14.0; *IR:* $\bar{\nu}$ 3116, 2923, 1651 (C=O), 1601, 1567, 1526, 1505, 1368, 1313, 1265, 1205, 1180, 1065, 1017, 965, 784, 727, 713, 623, 540; R_f (dichloromethane) 0.33; *Mass Spectrometry:* TOF ES^+ : MH^+ : Expected: m/z 217.0865, Observed: m/z 217.0868, Difference = -1.38 ppm

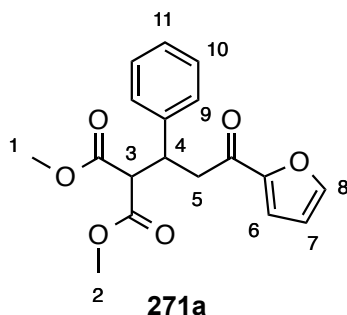
Synthesis of dimethyl-2-(3-(furan-2-yl)-3-oxo-1-phenylpropyl)malonate (271a)

Sodium hydride (60% in mineral oil) (0.210 g, 5.25 mmol, 1.90 eqv.) was suspended in tetrahydrofuran (14.0 mL) and cooled to -18°C . Dimethyl malonate (**276**) (0.600 mL, 5.25 mmol, 1.90 eqv.) was added dropwise over the course of two minutes. The reaction mixture was stirred for 15 minutes at room temperature. It was then again cooled to -18°C and (*E*)-1-(furan-2-yl)-3-phenyl-2-propen-1-one (**272a**) (0.550 g, 2.77 mmol, 1.00 eqv.) in tetrahydrofuran (5.00 mL) was added. The reaction was stirred at room temperature for 2.5 hours. The reaction mixture was then diluted with saturated ammonium chloride (20.0 mL) and diethyl ether (20.0 mL). Extraction was completed using diethyl ether (3×20.0 mL). The combined organic phases were then washed with saturated sodium bicarbonate (2×50.0 mL), water (50.0 mL) and brine (50.0 mL). This was then dried over magnesium sulfate and concentrated under reduced pressure prior to analysis. The material was purified by column chromatography using a graduated solvent system reaching a 1:1 mixture of petroleum ether and diethyl ether. The purified product obtained was a white solid.

Yield: 60% (0.548 g, 1.66 mmol); $^1\text{H-NMR}$ (CDCl_3 , 300MHz): δ 7.53 ($J = 1.7$ Hz, 1H, d, H-8), 7.25 – 7.17 (5H, m, H-9, H-10 and H-11), 7.15 ($J = 3.6$ Hz, 1H, d, H-

6), 6.48 (J = 1.7, 3.6 Hz, 1H, dd, H-7), 4.16 (J = 4.7, 7.6, 9.7 Hz, 1H, ddd, H-4), 3.85 (J = 9.7, 1H, d, H-3), 3.73 (3H, s, OMe), 3.50 (3H, s, OMe), 3.34 (J = 4.7, 7.6 Hz, 2H, dd, H-5); $^{13}\text{C-NMR}$ (CDCl_3 , 75 MHz): δ 186.4 (C=O), 168.5 (C=O), 168.0 (C=O), 152.4, 146.3, 140.0, 128.4, 128.0, 127.1, 117.2, 112.2, 57.1, 52.6, 52.4, 42.1, 40.5; *IR*: $\bar{\nu}$ 3126, 3098, 2958, 1724 (C=O), 1664 (C=O), 1497, 1421, 1294, 1237, 1219, 1153, 1095, 1045, 980, 918, 860; *Melting Point*: 114 – 115 °C; *R_f* (7:3 petroleum ether : diethyl ether) 0.27; *Mass Spectrometry*: TOF ES⁺: MNa⁺: Expected: *m/z* 353.1001, Observed: *m/z* 353.1017, Difference = 4.53 ppm

Potassium Carbonate Method

(*E*)-1-(furan-2-yl)-3-phenyl-2-propen-1-one (**272a**) (4.60 g, 23.2 mmol, 1.00 eqv.) was dissolved in methanol (100 mL). To this was added dimethyl malonate (**276**) (5.50 mL, 48.1 mmol, 2.07 eqv.) and potassium carbonate (3.58 g, 25.9 mmol, 1.12 eqv.). The reaction was stirred at reflux for two hours. After, the reaction mixture was concentrated to approximately 10.0 mL, before being diluted with diethyl ether (50.0 mL) and water (100 mL). Extraction was achieved with diethyl ether (3 × 50.0 mL). The combined organic phases were washed with water (2 × 75.0 mL) and brine (75.0 mL) before being dried over magnesium sulfate and concentrated under reduced pressure. The product was purified by column chromatography using a graduated solvent system reaching a 1:1 mixture of hexane and diethyl ether.

Yield: 65% (5.01 g, 15.2 mmol)

Synthesis of dimethyl-2-(1-(4-chlorophenyl)-3-(furan-2-yl)-3-oxopropyl)malonate
(271b)

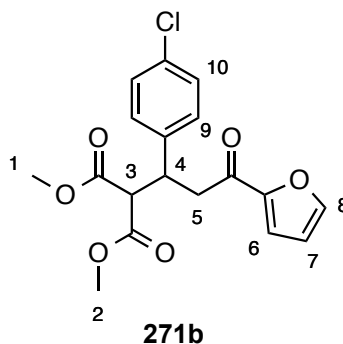

Experimental procedure followed matched that described for **271a** with sodium hydride using:

Sodium hydride (60% in mineral oil) (0.410 g, 10.1 mmol, 4.35 eqv.), dimethyl malonate (**276**) (1.00 mL, 8.60 mmol, 3.71 eqv.), (*E*)-3-(4-chlorophenyl)-1-(furan-2-yl)prop-2-en-1-one (**272b**) (0.549 g, 2.32 mmol, 1.00 eqv.) and THF (20.0 mL). The product was a yellow crystalline solid.

¹H-NMR (CDCl₃, 300 MHz): δ 7.53 (J = 1.7 Hz, 1H, d, H-8), 7.24 – 7.21 (4H, s, H-9 and H-10), 7.15 (J = 3.6 Hz, 1H, d, H-6), 6.49 (J = 1.7, 3.6 Hz, 1H, dd, H-7), 4.13 (J = 4.4, 7.7, 9.7 Hz, 1H, ddd, H-4), 3.81 (J = 9.7 Hz, 1H, d, H-3), 3.73 (3H, s, OMe), 3.52 (3H, s, OMe), 3.32 (J = 4.4, 7.7 Hz, 2H, dd, H-5); ¹³C-NMR (CDCl₃, 75 MHz): δ 186.2 (C=O), 168.3 (C=O), 167.8 (C=O), 152.4, 146.4, 138.6, 133.0, 129.5, 128.6, 117.2, 112.3, 56.9, 52.8, 52.5, 41.9, 39.9; IR: ν̄ 2956, 2923, 2853, 1726 (C=O), 1662 (C=O), 1467, 1433, 1399, 1274, 1251, 1157, 1090, 1039, 993, 910, 876, 831; *Melting Point*: 78 °C; *R_f* (7:3 petroleum ether : diethyl ether) 0.17; *Mass Spectrometry*: TOF ES⁺: MNa⁺: Expected: *m/z* 387.0611, Observed: *m/z* 387.0619, Difference = 2.07 ppm

Synthesis of dimethyl-2-(3-(furan-2-yl)-1-(4-methoxyphenyl)-3-oxopropyl)malonate
(271c)

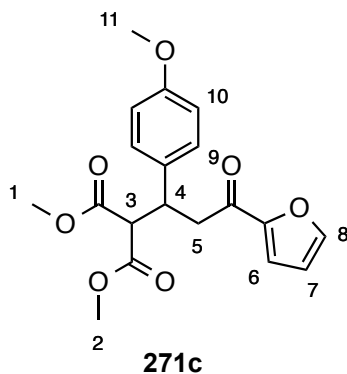

Experimental procedure followed matched that described for **271a** with sodium hydride using:

Sodium hydride (60% in mineral oil) (0.492 g, 12.3 mmol, 5.10 eqv.), dimethyl malonate (**276**) (1.05 mL, 9.14 mmol, 3.79 eqv.), (*E*)-1-(furan-2-yl)-3-(4-methoxyphenyl)prop-2-en-1-one (**272c**) (0.543 g, 2.41 mmol, 1.00 eqv.) and THF (10.0 mL). The product was a pale yellow solid.

Yield: 49% (0.42 g, 1.17 mmol); ¹H-NMR (CDCl₃, 300 MHz): δ 7.52 (J = 1.6 Hz, 1H, d, H-8), 7.16 (J = 8.7 Hz, 2H, d, H-9), 7.14 (J = 3.5 Hz, 1H, d, H-6), 6.77 (J = 8.7 Hz, 2H, d, H-10), 6.47 (J = 1.6, 3.5 Hz, 1H, dd, H-7), 4.10 (J = 4.7, 8.6, 9.8 Hz, 1H, ddd, H-4), 3.80 (J = 9.8 Hz, 1H, d, H-3), 3.71 (3H, s, OMe), 3.70 (3H, s, OMe), 3.49 (3H, s, OMe), 3.29 (J = 4.7, 9.8 Hz, 2H, dd, H-5); ¹³C-NMR (CDCl₃, 75 MHz): δ 186.5 (C=O), 168.6 (C=O), 168.0 (C=O), 158.4, 152.4, 146.3, 131.9, 129.0, 117.2, 113.7, 112.2, 57.3, 55.0, 52.6, 52.4, 42.2, 39.9; IR: ν̄ 2956, 2838, 1727 (C=O), 1665 (C=O), 1612, 1515, 1474, 1402, 1289, 1270, 1252, 1159, 1115, 1045, 1032, 981, 919, 861, 827, 769, 734, 598, 563, 533; *Melting Point*: 115 – 116

°C; R_f (7:3 petroleum ether : diethyl ether) 0.18; *Mass Spectrometry*: TOF ES⁺: MNa⁺: Expected: m/z 383.1107, Observed: m/z 383.1094, Difference = -3.39 ppm

The experiment was later repeated and the Experimental procedure followed matched that described for **271a** with potassium carbonate using:

(*E*)-1-(furan-2-yl)-3-(4-methoxyphenyl)prop-2-en-1-one (**272c**) (4.77 g, 20.9 mmol, 1.00 eqv.), dimethyl malonate (**276**) (5.52 mL, 48.1 mmol, 2.30 eqv.), potassium carbonate (2.92 g, 21.2 mmol, 1.01 eqv.) and methanol (100 mL). The material was taken through to the next step with no purification.

Synthesis of dimethyl-2-(3-(furan-2-yl)-3-oxo-1-*p*-tolylpropyl)malonate (**271d**)

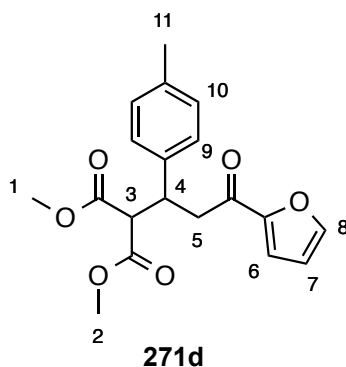

Experimental procedure followed matched that described for **271a** with sodium hydride using:

Sodium hydride (60% in mineral oil) (0.287 g, 7.07 mmol, 2.95 eqv.), dimethyl malonate (**276**) (0.860 mL, 7.52 mmol, 3.13 eqv.), (*E*)-1-(furan-2-yl)-3-*p*-tolylprop-2-en-1-one (**272d**) (0.507 g, 2.40 mmol, 1.00 eqv.) and THF (10.0 mL). The product was a cream solid.

Yield: 59% (0.49 g, 1.42 mmol); $^1\text{H-NMR}$ (CDCl_3 , 300 MHz): δ 7.53 (J = 1.6 Hz, 1H, d, H-8), 7.14 (J = 3.2 Hz, 1H, d, H-6), 7.13 (J = 7.9 Hz, 2H, d, H-9), 7.04 (J = 7.9 Hz, 2H, d, H-10), 6.48 (J = 1.6, 3.2 Hz, 1H, dd, H-7), 4.12 (J = 4.4, 6.8, 9.5 Hz, 1H, ddd, H-4), 3.83 (J = 9.5 Hz, 1H, d, H-3), 3.73 (3H, s, OMe), 3.51 (3H, s, OMe), 3.33 (J = 4.4, 6.8 Hz, 2H, dd, H-5), 2.26 (3H, s, H-11); $^{13}\text{C-NMR}$ (CDCl_3 , 75 MHz): δ 186.6 (C=O), 168.6 (C=O), 168.1 (C=O), 152.5, 146.3, 136.9, 136.8, 129.2, 127.8, 117.2, 112.2, 57.3, 52.7, 52.4, 42.2, 40.2, 21.0; *IR:* $\bar{\nu}$ 3126, 3097, 2948, 1730 (C=O), 1665 (C=O), 1473, 1433, 1401, 1319, 1273, 1250, 1241, 1151, 1044, 1022, 992, 974, 912, 820, 770, 596, 552; *Melting Point:* 88 – 89 °C; *R_f* (7:3 petroleum ether : diethyl ether) 0.20; *Mass Spectrometry:* TOF ES⁺: MNa⁺: Expected: *m/z* 367.1158, Observed: *m/z* 367.1174, Difference = 4.36 ppm

Synthesis of dimethyl-2-(1-(3,4-dimethoxyphenyl)-3-(furan-2-yl)-3-oxopropyl)malonate (271e)

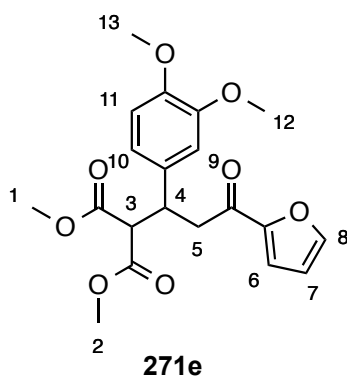

Experimental procedure followed matched that described for **316a** with sodium hydride using:

Sodium hydride (60% in mineral oil) (0.373 g, 9.25 mmol, 4.60 eqv.), dimethyl malonate (**276**) (1.00 mL, 8.75 mmol, 4.35 eqv.), (*E*)-3-(3,4-dimethoxyphenyl)-1-

(furan-2-yl)prop-2-en-1-one (**272e**) (0.515 g, 2.01 mmol, 1.00 eqv.) and THF (11.5 mL). The purified product was a yellow oil.

$^1\text{H-NMR}$ (CDCl_3 , 300 MHz): δ 7.55 (J = 1.7 Hz, 1H, d, H-8), 7.14 (J = 3.6 Hz, 1H, d, H-6), 6.80 – 6.71 (3H, m, H-9, H-10 and H-11), 6.48 (J = 1.7, 3.6 Hz, 1H, dd, H-7), 4.10 (J = 5.3, 8.9, 9.3 Hz, 1H, ddd, H-4), 3.83 (J = 9.3 Hz, 1H, d, H-3), 3.82 (3H, s, OMe), 3.80 (3H, s, OMe), 3.73 (3H, s, OMe), 3.52 (3H, s, OMe), 3.35 (J = 8.9, 16.4 Hz, 1H, dd, H-5), 3.26 (J = 5.3, 16.4 Hz, 1H, dd, H-5'); $^{13}\text{C-NMR}$ (CDCl_3 , 75 MHz): δ 186.6 (C=O), 168.6 (C=O), 168.1 (C=O), 152.5, 148.5, 147.9, 146.3, 132.5, 119.8, 117.2, 112.2, 111.4, 110.9, 57.3, 55.8, 55.7, 52.7, 52.5, 42.1, 40.3; *IR*: $\bar{\nu}$ 3108, 3020, 2973, 2863, 2857, 1731 (C=O), 1651 (C=O), 1513, 1439, 1373, 1251, 1226, 1141, 1121, 1078, 1009, 908, 875, 804, 750, 601, 587, 506; *R_f* (7:3 petroleum ether : diethyl ether) 0.14; *Mass Spectrometry*: TOF ES⁺: MNa⁺: Expected: *m/z* 413.1212, Observed: *m/z* 413.1216, Difference = 0.97 ppm

Synthesis of dimethyl-2-(1-(4-bromophenyl)-3-(furan-2-yl)-3-oxopropyl)malonate (**271f**)

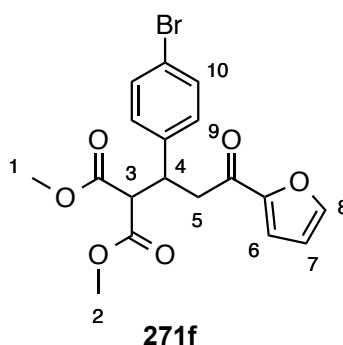

Experimental procedure followed matched that described for **271a** with sodium hydride using:

Sodium hydride (60% in mineral oil) (0.413 g, 10.3 mmol, 5.60 eqv.), dimethyl malonate (**276**) (1.20 mL, 10.5 mmol, 5.71 eqv.), (*E*)-3-(4-bromophenyl)-1-(furan-2-yl)prop-2-en-1-one (**272f**) (0.513 g, 1.84 mmol, 1.00 eqv.) and THF (10.0 mL). The product was a cream coloured solid.

$^1\text{H-NMR}$ (CDCl_3 , 300 MHz): δ 7.54 (J = 1.7 Hz, 1H, d, H-8), 7.34 (J = 8.5 Hz, 2H, d, H-9), 7.17 – 7.13 (J = 8.5 Hz, 2H, d, H-10), 7.15 (J = 3.6 Hz, 1H, dd, H-6), 6.46 (J = 1.7, 3.6 Hz, 1H, dd, H-7), 4.12 (J = 4.6, 7.8, 9.0 Hz, 1H, ddd, H-4), 3.81 (J = 9.0 Hz, 1H, d, H-3), 3.70 (3H, s, OMe), 3.49 (3H, s, OMe), 3.32 (J = 4.6, 7.8, 2H, dd, H-5); $^{13}\text{C-NMR}$ (CDCl_3 , 75 MHz): δ 186.0 (C=O), 168.2 (C=O), 167.7 (C=O), 152.2, 146.3, 139.1, 131.4, 129.8, 121.0, 117.2, 112.2, 56.7, 52.6, 52.4, 41.7, 39.8; *IR*: $\bar{\nu}$ 3131, 2955, 2924, 2854, 1740 (C=O), 1724 (C=O), 1660, 1488, 1466, 1397, 1306, 1253, 1217, 1065, 991, 909, 827, 765, 719, 554, 525; *Melting Point*: 78 – 79 °C; *R_f* (7:3 petroleum ether : diethyl ether) 0.23; *Mass Spectrometry*: TOF ES⁺: MNa⁺: Expected: *m/z* 431.0106, Observed: *m/z* 431.0119, Difference = 3.02 ppm

The experiment was later repeated and the Experimental procedure followed matched that described for **271a** with potassium carbonate using: (*E*)-3-(4-bromophenyl)-1-(furan-2-yl)prop-2-en-1-one (**272f**) (16.4 g, 59.2 mmol, 1.00 eqv.), dimethyl malonate (**276**) (14.0 mL, 123 mmol, 2.08 eqv.), potassium carbonate (8.20 g, 59.3 mmol, 1.00 eqv.) and methanol (200 mL).

Yield: 77% (18.7 g, 45.7 mmol)

Synthesis of dimethyl-2-(1-(4-bromophenyl)-3-(5-methylfuran-2-yl)-3-oxopropyl)malonate (**271h**)

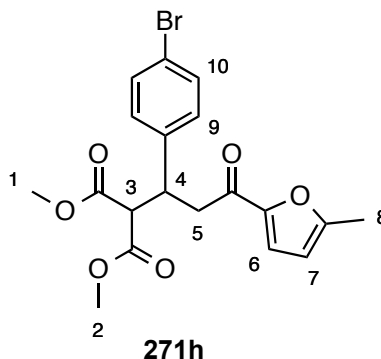

Experimental procedure followed matched that described for **271a** with sodium hydride using:

Sodium hydride (60% in mineral oil) (0.275 g, 7.00 mmol, 3.78 eqv.), dimethyl malonate (**276**) (0.800 mL, 7.00 mmol, 3.78 eqv.), (*E*)-3-(4-bromophenyl)-1-(5-methylfuran-2-yl)prop-2-en-1-one (**272h**) (0.543 g, 1.85 mmol, 1.00 eqv.) and THF (12.0 mL). The product was a pale yellow oil.

¹H-NMR (CDCl₃, 300 MHz): δ 7.36 (J = 8.3 Hz, 2H, d, H-9), 7.14 (J = 8.3 Hz, 2H, H-10) 7.07 (J = 3.4 Hz, 1H, d, H-6), 6.10 (J = 3.4 Hz, 1H, d, H-7), 4.10 (J = 4.5, 8.0, 9.1 Hz, 1H, ddd, H-4), 3.81 (J = 9.1 Hz, 1H, d, H-3), 3.73 (3H, s, OMe), 3.52 (3H, s, OMe), 3.24 (J = 4.5, 8.0 Hz, 2H, dd, H-5), 2.34 (3H, s, H-8); ¹³C-NMR (CDCl₃, 75 MHz): δ 185.3 (C=O), 168.3 (C=O), 167.8 (C=O), 157.9, 151.1, 139.2, 131.5, 129.9, 121.1, 119.4, 109.0, 56.8, 52.7, 52.5, 41.5, 40.2, 14.0; IR: ν̄ 2953, 2923, 2852, 1730 (C=O), 1660 (C=O), 1514, 1488, 1433, 1241, 1159, 1074, 1038, 1010, 826, 795, 556; R_f (7:3 petroleum ether : diethyl ether) 0.24; Mass Spectrometry: TOF ES⁺: MNa⁺: Expected: m/z 445.0263, Observed: m/z 445.0278, Difference = 3.37 ppm

The experiment was later repeated and the Experimental procedure followed matched that described for **271a** with potassium carbonate using:

(*E*)-3-(4-bromophenyl)-1-(5-methylfuran-2-yl)prop-2-en-1-one (**272h**) (12.0 g, 41.2 mmol, 1.00 eqv.), dimethyl malonate (**276**) (9.50 mL, 83.1 mmol, 2.02 eqv.), potassium carbonate (6.05 g, 43.8 mmol, 1.06 eqv.) and methanol (300 mL).

Yield: 79% (13.8 g, 32.6 mmol)

Synthesis of dimethyl-2-(3-(5-methylfuran-2-yl)-3-oxo-1-phenylpropyl)malonate (**271i**)

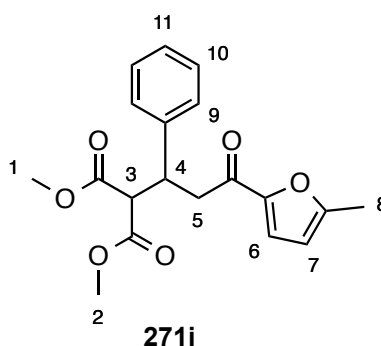

Experimental procedure followed matched that described for **271a** with sodium hydride using:

Sodium hydride (60% in mineral oil) (0.403 g, 10.0 mmol, 4.20 eqv.), dimethyl malonate (**276**) (1.10 mL, 9.62 mmol, 4.04 eqv.), (*E*)-1-(5-methylfuran-2-yl)-3-phenylprop-2-en-1-one (**272i**) (0.504 g, 2.38 mmol, 1.00 eqv.) and THF (10.0 mL).

The product was a white solid.

¹H-NMR (CDCl₃, 300 MHz): δ 7.25 – 7.15 (5H, m, H-9, H-10 and H-11), 7.07 (J = 3.5 Hz, 1H, d, H-6), 6.09 (J = 3.5 Hz, 1H, d, H-7), 4.14 (J = 4.8, 7.6, 9.7 Hz, 1H,

ddd, H-4), 3.86 (J = 9.7 Hz, 1H, d, H-3), 3.73 (3H, s, OMe), 3.49 (3H, s, OMe), 3.27 (J = 4.8, 7.6 Hz, 2H, dd, H-5), 2.34 (3H, s, H-8); $^{13}\text{C-NMR}$ (CDCl_3 , 75 MHz): δ 185.7 (C=O), 168.6 (C=O), 168.1 (C=O), 157.7, 151.3, 140.1, 128.4, 128.1, 127.2, 119.3, 108.9, 57.2, 52.7, 52.4, 41.9, 40.9, 14.0; *IR*: $\bar{\nu}$ 2954, 2922, 2852, 1746, 1727, 1659, 1516, 1433, 1252, 1205, 1149, 1074, 1040, 1027, 956, 904, 788, 702, 594, 530; *Melting Point*: 112 – 113 °C; *R_f* (7:3 petroleum ether : diethyl ether) 0.25; *Mass Spectrometry*: TOF ES⁺: MNa⁺: Expected: *m/z* 367.1158, Observed: *m/z* 367.1140, Difference = -4.90 ppm

*Synthesis of dimethyl-2-(3-(5-methylfuran-2-yl)-3-oxo-1-*p*-tolylpropyl)malonate (271j)*

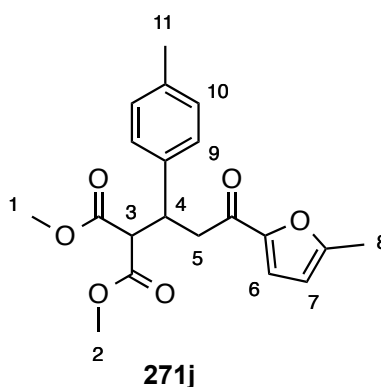

Experimental procedure followed matched that described for **271a** with sodium hydride using:

Sodium hydride (60% in mineral oil) (0.399 g, 10.0 mmol, 4.10 eqv.), dimethyl malonate (**276**) (1.10 mL, 9.62 mmol, 3.94 eqv.), (*E*)-1-(5-methylfuran-2-yl)-3-*p*-tolylprop-2-en-1-one (**272j**) (0.552 g, 2.44 mmol, 1.00 eqv.) and THF (12.0 mL). The product was a pale yellow solid.

$^1\text{H-NMR}$ (CDCl_3 , 300 MHz): δ 7.13 ($J = 8.1$ Hz, 2H, d, H-9), 7.08 ($J = 3.5$ Hz, 1H, d, H-6), 7.04 ($J = 8.1$ Hz, 2H, d, H-10), 6.09 ($J = 3.5$ Hz, 1H, d, H-7), 4.10 ($J = 6.1$, 8.0, 9.5 Hz, 1H, ddd, H-4), 3.83 ($J = 9.5$ Hz, 1H, d, H-3), 3.73 (3H, s, OMe), 3.51 (3H, s, OMe), 3.25 ($J = 8.0$ Hz, 1H, d, H-5), 3.24 ($J = 6.1$ Hz, 1H, d, H-5'), 2.34 (3H, s, H-8), 2.25 (3H, s, H-11); $^{13}\text{C-NMR}$ (CDCl_3 , 75 MHz): δ 185.8 (C=O), 168.7 (C=O), 168.1 (C=O), 157.7, 151.3, 137.0, 136.7, 129.1, 127.9, 119.3, 108.9, 57.3, 52.6, 52.4, 41.9, 40.5, 21.0, 14.0; *IR*: $\bar{\nu}$ 2953, 2922, 2852, 1729 (C=O), 1660 (C=O), 1432, 1301, 1239, 1221, 1161, 1144, 1081, 1041, 959, 906, 816, 794, 772, 560; *Melting Point*: 103 – 104 °C; R_f (7:3 petroleum ether : diethyl ether) 0.23; *Mass Spectrometry*: TOF ES^+ : MNa^+ : Expected: m/z 381.1314, Observed: m/z 381.1311, Difference = -0.79 ppm

Synthesis of dimethyl-2-(1-(4-chlorophenyl)-3-(5-methylfuran-2-yl)-3-oxopropyl)malonate (271k)

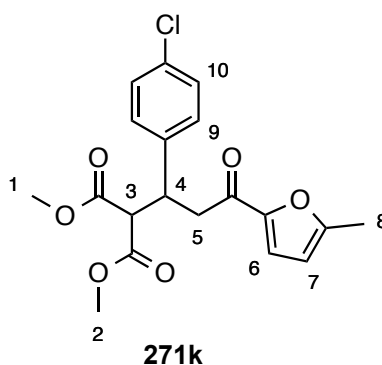

Experimental procedure followed matched that described for **271a** with sodium hydride using:

Sodium hydride (60% in mineral oil) (0.343 g, 8.25 mmol, 3.57 eqv.), dimethyl malonate (**276**) (1.00 mL, 8.75 mmol, 3.79 eqv.), (*E*)-3-(4-chlorophenyl)-1-(5-

methylfuran-2-yl)prop-2-en-1-one (**272k**) (0.571 g, 2.31 mmol, 1.00 eqv.) and THF (12.0 mL). The product was a pale orange solid.

$^1\text{H-NMR}$ (CDCl_3 , 300 MHz): δ 7.13 (4H, s, H-9 and H-10), 7.06 (J = 3.5 Hz, 1H, d, H-6), 6.08 (J = 3.5 Hz, 1H, d, H-7), 4.10 (J = 4.2, 8.0, 9.7 Hz, 1H, ddd, H-4), 3.79 (J = 9.7 Hz, 1H, d, H-3), 3.71 (3H, s, OMe), 3.49 (3H, s, OMe), 3.21 (J = 4.2, 8.0 Hz, 2H, dd, H-5), 2.31 (3H, s, H-8); $^{13}\text{C-NMR}$ (CDCl_3 , 75 MHz): δ 185.4 (C=O), 168.4 (C=O), 167.9 (C=O), 157.9, 151.2, 138.7, 132.9, 129.5, 128.6, 119.4, 109.0, 56.9, 52.8, 52.5, 41.6, 40.2, 14.1; *IR*: $\bar{\nu}$ 2954, 2938, 2876, 1728 (C=O), 1660 (C=O), 1515, 1491, 1435, 1239, 1164, 1039, 1015, 907, 864, 795, 728, 648, 559; *Melting Point*: 88 °C; *R_f* (7:3 petroleum ether : diethyl ether) 0.25; *Mass Spectrometry*: TOF ES⁺: MH⁺: Expected: *m/z* 379.0948, Observed: *m/z* 379.0953, Difference = -1.32 ppm

Synthesis of methyl-5-(furan-2-yl)-5-oxo-3-phenylpentanoate (**270a**)

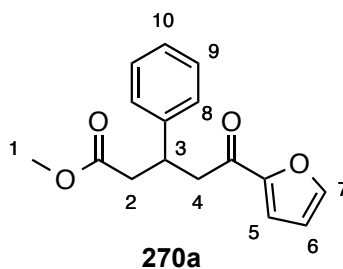

Dimethyl-2-(3-(furan-2-yl)-3-oxo-1-phenylpropyl)malonate (**271a**) (0.320 g, 0.969 mmol, 1.00 eqv.) was dissolved in a 5:1 mixture of DMSO and water (5.00 mL). Lithium chloride (1.77 g, 38.7 mmol, 39.9 eqv.) was added and the reaction was stirred at reflux for 5 days. After, the reaction mixture was diluted with diethyl ether (30.0 mL) and water (30.0 mL). Extraction was completed using diethyl ether (3 ×

30.0 mL) and the combined organic phases were washed with water (2 × 50.0 mL) and brine (50.0 mL). This was then dried over magnesium sulfate and concentrated under reduced pressure. The crude material was then purified *via* column chromatography using a graduated solvent system reaching a 1:1 mixture of petroleum ether and diethyl ether. The product was a white solid.

Yield: 46% (0.120 g, 0.441 mmol); $^1\text{H-NMR}$ (CDCl_3 , 300 MHz): δ 7.51 (J = 1.7 Hz, 1H, d, H-7), 7.28 – 7.14 (5H, m, H-8, H-9 and H-10), 7.13 (J = 3.6 Hz, 1H, d, H-5), 6.47 (J = 1.7, 3.6 Hz, 1H, dd, H-6), 3.83 (J = 7.3, 7.3, 7.4, 7.4 Hz, 1H, dddd, H-3), 3.55 (3H, s, H-1), 3.19 (J = 7.3 Hz, 2H, d, H-4), 2.71 (J = 7.4 Hz, 2H, d, H-2); $^{13}\text{C-NMR}$ (CDCl_3 , 75 MHz): δ 187.2 (C=O), 172.1 (C=O), 152.6, 146.3, 142.9, 128.5, 127.2, 126.8, 117.1, 112.2, 51.5, 44.3, 40.4, 37.4; *IR:* $\bar{\nu}$ 3146, 3129, 3099, 3028, 3003, 2950, 2909, 1726 (C=O), 1658 (C=O), 1566, 1465, 1429, 1396, 1287, 1245, 1219, 1197, 1157, 1086, 1064, 1042, 1027, 986, 970, 918, 882, 778, 761, 702, 594, 555, 493; *Melting Point:* 85 – 86 °C; R_f (1:1 petroleum ether : diethyl ether) 0.31; *Mass Spectrometry:* TOF ES $^+$: MNa $^+$: Expected: m/z 295.0946, Observed: m/z 295.0945, Difference = -0.34 ppm

Synthesis of methyl-3-(4-chlorophenyl)-5-(furan-2-yl)-5-oxopentanoate (**270b**)

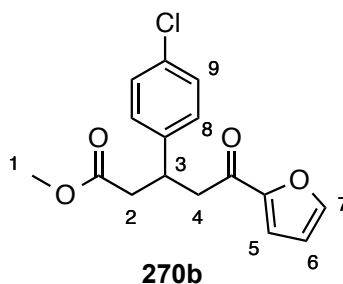

Experimental procedure followed matched that described for **270a** using:

Dimethyl-2-(1-(4-chlorophenyl)-3-(5-methylfuran-2-yl)-3-oxopropyl)malonate

(**271b**) (0.384 g, 1.04 mmol, 1.00 eqv), lithium chloride (2.40 g, 56.6 mmol, 54.4 eqv) and DMSO (8.00 mL). The product was a white solid.

Yield: 6% over two steps (0.0403 g, 0.131 mmol); $^1\text{H-NMR}$ (CDCl_3 , 300 MHz): δ 7.55 (J = 1.7 Hz, 1H, d, H-7), 7.24 (J = 8.3 Hz, 2H, d, H-9), 7.20 (J = 8.3 Hz, 2H, d, H-8), 7.16 (J = 3.6 Hz, 1H, d, H-5), 6.51 (J = 1.7, 3.6 Hz, 1H, dd, H-6), 3.83 (J = 7.2, 7.2, 7.4, 7.4 Hz, 1H, dddd, H-3), 3.58 (3H, s, H-1), 3.20 (J = 7.2 Hz, 2H, d, H-4), 2.78 (J = 7.4, 15.7 Hz, 1H, dd, H-2), 2.66 (J = 7.4, 15.7 Hz, 1H, dd, H-2'); $^{13}\text{C-NMR}$ (CDCl_3 , 75 MHz): δ 186.9 (C=O), 171.9 (C=O), 152.6, 146.4, 141.4, 132.5, 128.7 (2 \times C), 117.2, 112.3, 51.7, 44.1, 40.3, 36.8; *IR*: $\bar{\nu}$ 3124, 3098, 2959, 1722 (C=O), 1662 (C=O), 1473, 1430, 1363, 1306, 1266, 1216, 1160, 1088, 1066, 1042, 1014, 873, 827, 770, 669, 597, 537, 519, 402; *Melting Point*: 83 – 84 °C; R_f (1:1 petroleum ether : diethyl ether) 0.31; *Mass Spectrometry*: TOF ES⁺: MNa⁺: Expected: m/z 329.0557, Observed: m/z 329.0566, Difference = 2.74 ppm

Synthesis of methyl-5-(furan-2-yl)-3-(4-methoxyphenyl)-5-oxopentanoate (**270c**)

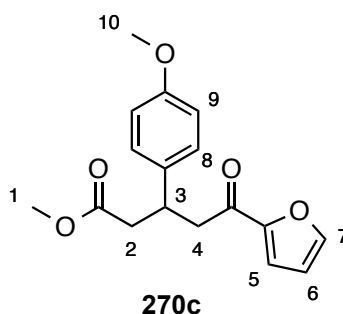

Experimental procedure followed matched that described for **270a** using:

Dimethyl-2-(3-(furan-2-yl)-1-(4-methoxyphenyl)-3-oxopropyl)malonate (**271c**) (0.609 g, 1.69 mmol, 1.00 eqv.), lithium chloride (2.81 g, 66.3 mmol, 39.2 eqv.) and DMSO (8.00 mL). The product was an off-white coloured oil.

Yield: 10% (0.0528 g, 0.175 mmol); $^1\text{H-NMR}$ (CDCl_3 , 300 MHz): δ 7.54 (J = 1.4 Hz, 1H, d, H-7), 7.19 – 7.13 (3H, m, H-5 and H-8), 6.80 (J = 8.6 Hz, 2H, d, H-9), 6.49 (J = 1.4, 3.5 Hz, 1H, dd, H-6), 3.85 – 3.75 (1H, m, H-3), 3.75 (3H, s, H-10), 3.57 (3H, s, H-1), 3.16 (J = 7.2 Hz, 2H, d, H-4), 2.70 (J = 7.5 Hz, 2H, d, H-2); $^{13}\text{C-NMR}$ (CDCl_3 , 75 MHz): δ 186.9 (C=O), 171.8 (C=O), 157.9, 152.2, 146.1, 134.6, 127.9, 116.9, 113.5, 111.9, 54.7, 51.1, 44.1, 40.2, 36.4; *IR:* $\bar{\nu}$ 2952, 2837, 1731 (C=O), 1670 (C=O), 1611, 1568, 1513, 1466, 1436, 1364, 1246, 1178, 1152, 1030, 883, 830, 763, 729, 595, 557; *R_f* (1:1 petroleum ether : diethyl ether) 0.43; *Mass Spectrometry:* TOF ES⁺: MNa⁺: Expected: *m/z* 325.1052, Observed: *m/z* 325.1059, Difference = 2.15 ppm

Synthesis of methyl-5-(furan-2-yl)-5-oxo-3-p-tolylpentanoate (**270d**)

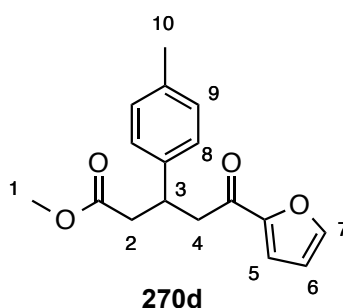

Experimental procedure followed matched that described for **270a** using:

Dimethyl-2-(3-(furan-2-yl)-3-oxo-1-p-tolylpropyl)malonate (**271d**) (0.200 g, 0.581 mmol, 1.00 eqv.), lithium chloride (1.11 g, 26.2 mmol, 45.1 eqv.) and DMSO (5.00 mL). The product was a pale yellow solid.

Yield: 29% (0.0586 g, 0.171 mmol); $^1\text{H-NMR}$ (CDCl_3 , 300 MHz): δ 7.54 (J = 1.7 Hz, 1H, d, H-7), 7.15 (J = 3.6 Hz, 1H, d, H-5), 7.14 – 7.07 (4H, m, H-8 and H-9), 6.50 (J = 1.7, 3.6 Hz, 1H, dd, H-6), 3.81 (J = 7.3, 7.3, 7.4, 7.4 Hz, 1H, dddd, H-3), 3.58 (3H, s, H-1), 3.18 (J = 7.3 Hz, 2H, d, H-4), 2.72 (J = 7.4 Hz, 2H, d, H-2), 2.28 (3H, s, H-10); $^{13}\text{C-NMR}$ (CDCl_3 , 75 MHz): δ 187.3 (C=O), 172.2 (C=O), 152.6, 146.3, 139.8, 136.3, 129.2, 127.0, 117.2, 112.2, 51.5, 44.4, 40.5, 37.0, 21.0; *IR:* $\bar{\nu}$ 3131, 2950, 1731 (C=O), 1670 (C=O), 1567, 1466, 1435, 1393, 1363, 1275, 1223, 1153, 1114, 1085, 1016, 883, 816, 763, 721, 595, 540, 494, 457; *Melting Point:* 67 – 68 °C; R_f (1:1 petroleum ether : diethyl ether) 0.24; *Mass Spectrometry:* TOF ES⁺: MH⁺: Expected: m/z 287.1283, Observed: m/z 287.1284, Difference = -0.35 ppm

Synthesis of methyl-3-(3,4-dimethoxyphenyl)-5-(furan-2-yl)-5-oxopentanoate (270e)

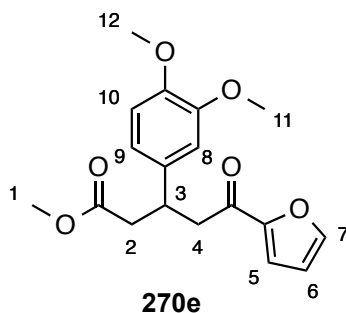

Experimental procedure followed matched that described for **270a** using:

Dimethyl-2-(1-(3,4-dimethoxyphenyl)-3-(furan-2-yl)-3-oxopropyl)malonate (**271e**) (0.600 g, 1.54 mmol, 1.00 eqv.), lithium chloride (3.31 g, 78.1 mmol, 50.7 eqv.) and 5:1 DMSO:water (12.0 mL). The product was a pale yellow solid.

Yield: 14% over 2 steps (0.0961 g, 0.289 mmol); $^1\text{H-NMR}$ (CDCl_3 , 300 MHz): δ 7.53 (J = 1.7 Hz, 1H, d, H-7), 7.13 (J = 3.6 Hz, 1H, d, H-5), 6.75 (3H, broad s, H-8, H-9 and H-10), 6.48 (J = 1.7, 3.6 Hz, 1H, dd, H-6), 3.83 (3H, s, H-12), 3.80 (3H, s, H-11), 3.78 (1H, m, H-3), 3.56 (3H, s, H-1), 3.16 (J = 7.2 Hz, 2H, d, H-4), 2.69 (J = 7.5 Hz, 2H, d, H-2); $^{13}\text{C-NMR}$ (CDCl_3 , 75 MHz): δ 187.3 (C=O), 172.1 (C=O), 152.6, 148.7, 147.6, 146.3, 135.4, 118.8, 117.1, 112.2, 111.1, 110.7, 55.7, 55.7, 51.5, 44.4, 40.6, 37.1; *IR:* $\bar{\nu}$ 3130, 3100, 3008, 2957, 2836, 1735 (C=O), 1658 (C=O), 1519, 1465, 1425, 1397, 1281, 1254, 1230, 1142, 1039, 1019, 999, 919, 859, 805, 776, 763, 661, 596, 520; *Melting Point:* 95 – 96 °C; R_f (1:1 petroleum ether : diethyl ether) 0.24; *Mass Spectrometry:* TOF ES^+ : MNa^+ : Expected: m/z 355.1158, Observed: m/z 355.1166, Difference = 2.25 ppm

Synthesis of methyl-3-(4-bromophenyl)-5-(furan-2-yl)-5-oxopentanoate (270f)

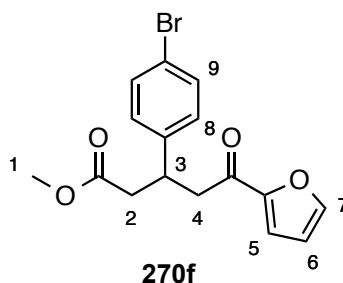

Experimental procedure followed matched that described for **270a** using:

Dimethyl-2-(1-(4-bromophenyl)-3-(furan-2-yl)-3-oxopropyl)malonate (**271f**) (0.105 g, 0.269 mmol, 1.00 eqv.), lithium chloride (0.464 g, 10.8 mmol, 40.1 eqv.) and DMSO (5.00 mL). The product was a pale yellow solid.

Yield: 12% over two steps (0.0781 g, 0.222 mmol); $^1\text{H-NMR}$ (CDCl_3 , 300 MHz): δ 7.55 (J = 1.7 Hz, 1H, d, H-7), 7.40 (J = 8.5 Hz, 2H, d, H-8), 7.15 (J = 3.6 Hz, 1H, d,

H-5), 7.14 (J = 8.5 Hz, 2H, d, H-9), 6.51 (J = 1.7, 3.6 Hz, 1H, dd, H-6), 3.82 (J = 7.2, 7.2, 7.5, 7.5 Hz, 1H, dddd, H-3), 3.59 (3H, s, H-1), 3.17 (J = 7.2 Hz, 2H, d, H-4), 2.71 (J = 7.5 Hz, 2H, d, H-2); $^{13}\text{C-NMR}$ (CDCl_3 , 75 MHz): δ 186.9 (C=O), 171.9 (C=O), 152.6, 146.4, 141.9, 131.7, 129.1, 120.6, 117.2, 112.3, 51.7, 44.1, 40.2, 36.8; *IR*: $\bar{\nu}$ 3124, 3097, 2951, 1722 (C=O), 1662 (C=O), 1472, 1398, 1214, 1105, 1065, 1000, 950, 824, 769, 597, 535, 518; *Melting Point*: 84 – 85 °C; R_f (1:1 petroleum ether : diethyl ether) 0.40; *Mass Spectrometry*: TOF ES^+ : MNa^+ : Expected: m/z 373.0051, Observed: m/z 373.0069, Difference = 4.82 ppm

Synthesis of methyl-3-(4-bromophenyl)-5-(5-methylfuran-2-yl)-5-oxopentanoate (270h)

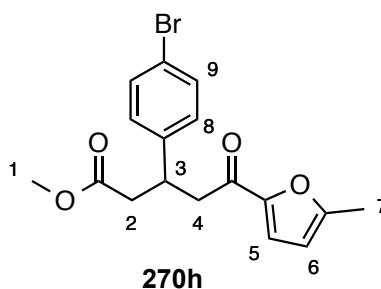

Experimental procedure followed matched that described for **270a** using:

Dimethyl-2-(1-(4-bromophenyl)-3-(5-methylfuran-2-yl)-3-oxopropyl)malonate

(**271h**) (0.507 g, 1.20 mmol, 1.00 eqv.), lithium chloride (2.09 g, 49.3 mmol, 41.1 eqv.) and DMSO (12.0 mL). The product was a pale yellow solid.

Yield: 25% (0.114 g, 0.301 mmol); $^1\text{H-NMR}$ (CDCl_3 , 300 MHz): δ 7.39 (J = 8.4 Hz, 2H, d, H-8), 7.14 (J = 8.4 Hz, 2H, d, H-9), 7.06 (J = 3.5 Hz, 1H, d, H-5), 6.12 (J = 3.5 Hz, 1H, d, H-6), 3.85 – 3.75 (1H, m, H-3), 3.58 (3H, s, H-1), 3.11 (J = 7.3 Hz, 2H, d, H-4), 2.71 (J = 7.5 Hz, 2H, d, H-2), 2.36 (3H, s, H-7); $^{13}\text{C-NMR}$ (CDCl_3 , 75

MHz): δ 186.1 (C=O), 171.9 (C=O), 158.0, 151.3, 142.0, 131.6, 129.1, 120.6, 119.4, 109.1, 51.7, 43.8, 40.2, 37.1, 14.1; *IR*: $\bar{\nu}$ 2952, 2916, 1735 (C=O), 1654 (C=O), 1516, 1489, 1437, 1220, 1165, 1104, 873, 823, 792, 725, 526; *Melting Point*: 78 – 79 °C; *R_f* (1:1 petroleum ether : diethyl ether) 0.48; *Mass Spectrometry*: TOF ES⁺: MNa⁺: Expected: *m/z* 387.0208, Observed: *m/z* 387.0225, Difference = 4.39 ppm

Synthesis of methyl-5-(5-methylfuran-2-yl)-5-oxo-3-phenylpentanoate (**270i**)

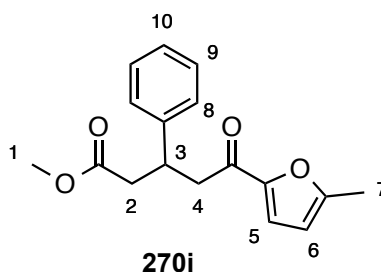

Experimental procedure followed matched that described for **270a** using:

Dimethyl-2-(3-(5-methylfuran-2-yl)-3-oxo-1-phenylpropyl)malonate (**271i**) (0.527 g, 1.54 mmol, 1.00 eqv.), lithium chloride (2.96 g, 69.8 mmol, 45.3 eqv.) and DMSO (12.0 mL). The product was a pale yellow solid.

Yield: 16% over 2 steps (0.106 g, 0.384 mmol); ¹H-NMR (CDCl₃, 400 MHz): δ 7.38 – 7.13 (5H, m, H-8, H-9 and H-10), 7.07 (J = 3.5 Hz, 1H, d, H-5), 6.11 (J = 3.5 Hz, 1H, d, H-6), 3.89 – 3.79 (1H, m, H-3), 3.57 (3H, s, H-1), 3.14 (J = 7.3 Hz, 2H, d, H-4), 2.75 (J = 7.5 Hz, 2H, d, H-2), 2.34 (3H, s, H-7); ¹³C-NMR (CDCl₃, 100 MHz): δ 186.5 (C=O), 172.2 (C=O), 157.8, 151.5, 143.1, 128.6, 127.3, 126.8, 119.2, 109.0, 51.5, 44.1, 40.4, 37.7, 14.0; *IR*: $\bar{\nu}$ 2952, 2896, 1730 (C=O), 1659 (C=O), 1515, 1456, 1372, 1360, 1284, 1248, 1211, 1161, 1090, 1074, 1034, 978, 882, 796, 783,

761, 699, 559, 536, 469; *Melting Point*: 100 – 101 °C; *R_f* (1:1 petroleum ether : diethyl ether) 0.53; *Mass Spectrometry*: TOF ES⁺: MH⁺: Expected: *m/z* 287.1283, Observed: *m/z* 287.1278, Difference = 1.74 ppm

Synthesis of methyl-5-(5-methylfuran-2-yl)-5-oxo-p-tolylpentanoate (270j)

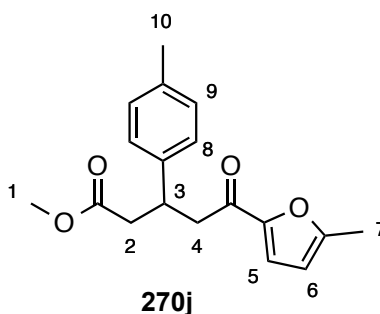

Experimental procedure followed matched that described for **270a** using:

Dimethyl-2-(3-(5-methylfuran-2-yl)-3-oxo-1-*p*-tolylpropyl)malonate (**271j**) (0.560 g, 1.56 mmol, 1.00 eqv.), lithium chloride (2.74 g, 64.6 mmol, 41.4 eqv.) and DMSO (8.00 mL). The product was a pale yellow solid.

Yield: 15% over 2 steps (0.105 g, 0.366 mmol); ¹H-NMR (CDCl₃, 300 MHz): δ 7.15 – 7.05 (5H, m, H-5, H-8 and H-9), 6.10 (J = 3.5 Hz, 1H, d, H-6), 3.79 (J = 7.3, 7.3, 7.4, 7.4 Hz, 1H, dddd, H-3), 3.56 (3H, s, H-1), 3.10 (J = 7.3 Hz, 2H, d, H-4), 2.71 (J = 7.4 Hz, 2H, d, H-2), 2.34 (3H, s, H-7), 2.27 (3H, s, H-10); ¹³C-NMR (CDCl₃, 75 MHz): δ 186.4 (C=O), 172.2 (C=O), 157.7, 151.3, 139.9, 136.1, 129.1, 127.0, 119.2, 108.8, 51.4, 44.1, 40.3, 37.2, 20.9, 13.9; *IR*: ν̄ 2951, 2920, 1729 (C=O), 1659 (C=O), 1515, 1435, 1270, 1223, 1211, 1162, 1037, 873, 816, 795, 722, 528; *Melting Point*: 79 - 80 °C; *R_f* (1:1 petroleum ether : diethyl ether) 0.43; *Mass Spectrometry*: TOF ES⁺: MNa⁺: Expected: *m/z* 323.1259, Observed: *m/z* 323.1248, Difference = -3.40 ppm

Synthesis of methyl-3-(4-chlorophenyl)-5-(5-methylfuran-2-yl)-5-oxopentanoate
(270k)

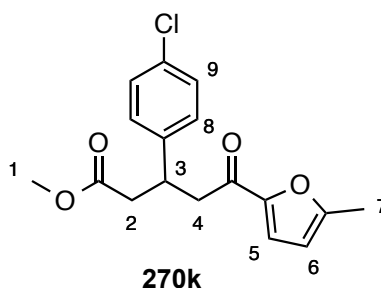

Experimental procedure followed matched that described for **270a** using:

Dimethyl-2-(1-(4-chlorophenyl)-3-(5-methylfuran-2-yl)-3-oxopropyl)malonate

(271k) (0.510 g, 1.35 mmol, 1.00 eqv.), lithium chloride (2.31 g, 54.5 mmol, 40.4 eqv.) and 5:1 DMSO:H₂O (12.0 mL). The product was a yellow solid.

Yield: 13% over 2 steps (0.0943 g, 0.293 mmol); ¹H-NMR (CDCl₃, 300 MHz): δ 7.23 – 7.16 (4H, m, H-8 and H-9), 7.05 (J = 3.5 Hz, 1H, d, H-5), 6.10 (J = 3.5 Hz, 1H, d, H-6), 3.80 (J = 7.3, 7.3, 7.3, 7.3 Hz, 1H, dddd, H-3), 3.56 (3H, s, H-1), 3.09 (J = 7.3 Hz, 2H, d, H-4), 2.70 (J = 7.33 Hz, 2H, d, H-2), 2.34 (3H, s, H-7); ¹³C-NMR (CDCl₃, 75 MHz): δ 185.9 (C=O), 171.8 (C=O), 157.8, 151.2, 141.4, 132.3, 128.6, 128.5, 119.3, 108.9, 51.5, 43.7, 40.1, 36.9, 13.9; *IR:* $\bar{\nu}$ 3120, 2998, 2953, 2920, 2849, 1735 (C=O), 1654 (C=O), 1514, 1492, 1423, 1369, 1271, 1220, 1209, 1164, 1088, 1036, 873, 825, 791, 729, 711, 537, 526; *Melting Point:* 66 – 67 °C; *R_f* (1:1 petroleum ether : diethyl ether) 0.29; *Mass Spectrometry:* TOF ES⁺: MNa⁺: Expected: *m/z* 343.0713, Observed: *m/z* 343.0706, Difference = –1.88 ppm

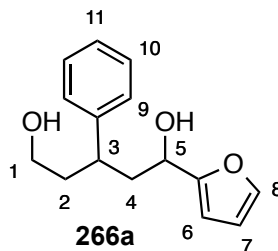
Synthesis of 1-(furan-2-yl)-3-phenylpentane-1,5-diol (266a)

THF (12.0 mL) was added to lithium aluminium hydride (1.15 g, 30.3 mmol, 10.2 eqv.). This was cooled to -15°C and methyl-5-(furan-2-yl)-5-oxo-3-phenylpentanoate (**270a**) (0.810 g, 2.97 mmol, 1.00 eqv.) was added in THF (8 mL). This was stirred at room temperature for 15 minutes and then it was quenched by adding diethyl ether (10.0 mL), followed by a 4:1 mixture of diethyl ether and acetone (10.0 mL). The reaction mixture was then diluted with ethyl acetate (40.0 mL), water (80.0 mL) and 2M sodium hydroxide solution (150 mL). Extraction was performed using ethyl acetate (3 \times 30.0 mL) and the combined organic phases were washed with water (2 \times 50.0 mL) and brine (50.0 mL). This was then dried over magnesium sulfate and concentrated under reduced pressure. The product was a yellow oil.

Diastereomeric Ratio: 1.4:1; *Yield:* 99% (0.725 g, 2.94 mmol); $^1\text{H-NMR}$ (CD_3CN , 300 MHz): δ 7.44 (J = 1.8 Hz, [1.4] 1H, d, H-8 [D-1]), 7.36 (J = 1.8 Hz, 1H, d, H-8 [D-2]), 7.31 – 7.13 ([1.4] 5H + 5H, m, H-9 [D-1], H-9 [D-2], H-10 [D-1], H-10 [D-2], H-11 [D-1] and H-11 [D-2]), 6.37 (J = 1.8, 3.2 Hz, [1.4] 1H, dd, H-7 [D-1]), 6.30 (J = 1.8, 3.2 Hz, 1H, dd, H-7 [D-2]), 6.20 (J = 3.2 Hz, [1.4] 1H, d, H-6 [D-1]), 6.14 (J = 3.2 Hz, 1H, d, H-6 [D-2]), 4.33 (J = 7.3, 7.3 Hz, [1.4] 1H, dd, H-5 [D-1]), 4.17 (J = 3.2, 10.0 Hz, 1H, dd, H-5 [D-2]), 3.40 – 3.17 ([1.4] 3H + 3H, m, H-1 [D-1], H-1 [D-

2], OH [D-1] and OH [D-2]), 3.10 – 2.98 ([1.4] 1H, m, H-3 [D-1]), 2.67 – 2.57 ([1.4] 1H + 2H, m, H-3 [D-2], OH [D-1] and OH [D-2]), 2.23 – 1.67 ([1.4] 4H + 4H, m, H-4 [D-1], H-4 [D-2], H-2 [D-1] and H-2 [D-2]); $^{13}\text{C-NMR}$ (CD_3CN , 75 MHz): δ 158.9, 157.9, 145.9, 145.5, 142.8, 142.5, 129.2, 128.7, 128.5, 127.1, 118.2, 110.9, 110.9, 107.0, 105.9, 65.6, 65.2, 60.4, 60.2, 43.2, 43.1, 40.6, 39.9, 39.2, 39.0; *IR*: $\bar{\nu}$ 3318 (O-H), 2921, 2850, 1494, 1453, 1145, 1043, 1009, 808, 762, 740, 701, 634, 598, 533, 493; *R_f* (Diethyl ether) 0.47; *Mass Spectrometry*: TOF ES^+ : MNa^+ : Expected: *m/z* 269.1154, Observed: *m/z* 269.1445, Difference = -3.34 ppm

Synthesis of 3-(4-chlorophenyl)-1-(furan-2-yl)pentan-1,5-diol (266b)

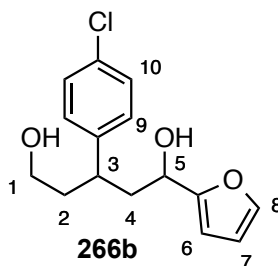

Experimental procedure followed matched that described for **266a** using:

Lithium aluminium hydride (0.156 g, 4.11 mmol, 11.8 eqv.), methyl-3-(4-chlorophenyl)-5-(furan-2-yl)-5-oxopentanoate (**270b**) (0.107 g, 0.349 mmol, 1.00 eqv.) and THF (25.0 mL). The product was a pale yellow oil.

Diastereomeric Ratio: 1.3:1; *Yield*: 99% (0.0967 g, 0.344 mmol); $^1\text{H-NMR}$ (CDCl_3 , 300 MHz): δ 7.39 (J = 1.8 Hz, [1.3] 1H, d, H-8 [D-1]), 7.32 (J = 1.9 Hz, 1H, dd, H-8 [D-2]), 7.31 – 7.26 ([1.3] 2H + 2H, m, H-10 [D-1] and H-10 [D-2]), 7.17 (J = 8.3 Hz, [1.3] 2H, d, H-9 [D-1]), 7.09 (J = 8.4 Hz, 2H, d, H-9 [D-2]), 6.33 (J = 1.8, 3.2 Hz, [1.3] 1H, dd, H-7 [D-1]), 6.29 (J = 1.9, 3.2 Hz, 1H, dd, H-7 [D-2]), 6.18 (J = 3.2 Hz,

[1.3] 1H, d, H-6 [D-1]), 6.15 (J = 3.2 Hz, 1H, d, H-6 [D-2]), 4.49 (J = 6.7, 7.9 Hz, [1.3] 1H, dd, H-5 [D-1]), 4.33 (J = 3.3, 10.4 Hz, 1H, dd, H-5 [D-2]), 3.61 – 3.36 ([1.3] 2H + 2H, m, H-1 [D-1] and H-1 [D-2]), 3.19 – 3.09 ([1.3] 1H, m, H-3 [D-1]), 2.75 – 2.64 (1H, m, H-3 [D-2]), 2.29 – 1.64 ([1.3] 4H + 4H, m, H-4 [D-1], H-4 [D-2], H-2 [D-1] and H-2 [D-2]); $^{13}\text{C-NMR}$ (CDCl_3 , 75 MHz): δ 156.7, 155.7, 142.7, 142.3, 141.9, 141.9, 132.1, 129.2, 128.9, 128.8, 128.7, 110.2, 110.1, 106.8, 105.6, 65.7, 65.0, 60.6, 60.5, 42.1, 41.8, 39.6, 38.9, 38.0, 37.7; *IR*: $\bar{\nu}$ 3314 (O-H), 2932, 1489, 1412, 1146, 1090, 1043, 1012, 824, 737, 634, 598, 534, 493; R_f (Diethyl ether) 0.38; *Mass Spectrometry*: TOF ES⁺: MH⁺: Expected: m/z 303.0764, Observed: m/z 303.0748, Difference = 5.26 ppm

These diastereoisomers were able to be separated into diastereomerically enriched mixtures with careful column chromatography in a graduated solvent system reaching pure diethyl ether.

First Diastereoisomer

$^1\text{H-NMR}$ (CDCl_3 , 300 MHz): δ 7.38 (J = 1.8 Hz, 1H, d, H-8), 7.27 (J = 8.4 Hz, 2H, d, H-10), 7.08 (J = 8.4 Hz, 2H, d, H-9), 6.33 (J = 1.8, 3.2 Hz, 1H, dd, H-7), 6.17 (J = 3.2 Hz, 1H, d, H-6), 4.49 (J = 6.2, 6.2 Hz, 1H, dd, H-5), 3.52 (1H, m, H-1), 3.39 (1H, m, H-1), 2.71 (1H, m, H-3), 2.30 – 1.70 (4H, m, H-2 and H-4); $^{13}\text{C-NMR}$ (CDCl_3 , 75 MHz): δ 155.7, 142.7, 142.2, 132.1, 128.9, 128.7, 110.2, 106.7, 65.6, 60.5, 42.1, 38.8, 38.0; *IR*: $\bar{\nu}$ 3328 (O-H), 2938, 2885, 1490, 1412, 1147, 1091, 1043, 1012, 909, 824, 730, 598

Second Diastereoisomer

$^1\text{H-NMR}$ (CDCl_3 , 300 MHz): δ 7.32 (J = 1.8 Hz, 1H, d, H-8), 7.28 (J = 8.5 Hz, 2H, d, H-10), 7.17 (J = 8.5 Hz, 2H, d, H-9), 6.29 (J = 1.8, 3.2 Hz, 1H, dd, H-7), 6.14 (J = 3.2 Hz, 1H, d, H-6), 4.33 (J = 3.3, 10.5 Hz, 1H, dd, H-5), 3.65 – 3.40 (2H, m, H-1), 3.14 (1H, m, H-3), 2.22 (J = 3.3, 10.5, 14.2 Hz, 1H, ddd, H-4), 2.05 – 1.80 (3H, m, H-2 and H-4); $^{13}\text{C-NMR}$ (CDCl_3 , 75 MHz): δ 156.7, 142.3, 141.9, 132.1, 129.2, 128.8, 110.1, 105.6, 65.1, 60.7, 41.9, 39.6, 37.8; *IR*: $\bar{\nu}$ 3332 (O-H), 2937, 2901, 1490, 1412, 1229, 1147, 1091, 1044, 1012, 909, 824, 732, 598

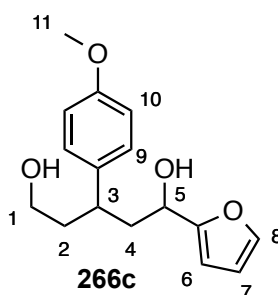
Synthesis of 1-(furan-2-yl)-3-(4-methoxyphenyl)pentane-1,5-diol (266c)

Experimental procedure followed matched that described for **266a** using:

Lithium aluminium hydride (119 mg, 3.11 mmol, 19.8 eqv.), methyl-5-(furan-2-yl)-3-(4-methoxyphenyl)-5-oxopentanoate (**270c**) (47.5 g, 0.157 mmol, 1.00 eqv.) and THF (5.00 mL). The product was a dark yellow oil.

Diastereomeric Ratio: **1.3:1**; *Yield*: 96% (41.7 mg, 0.151 mmol); $^1\text{H-NMR}$ (CDCl_3 , 300 MHz): δ 7.39 (J = 1.7 Hz, [1.3] 1H, d, **H-8 [D-1]**), 7.33 (1H, m, **H-8 [D-2]**), 7.15 (J = 8.5 Hz, 2H, d, **H-9 [D-2]**), 7.07 (J = 8.3 Hz, [1.3] 2H, d, **H-9 [D-1]**), 6.87 – 6.84 ([1.3] 2H + 2H, m, **H-10 [D-1]** and **H-10 [D-2]**), 6.33 (J = 1.7, 2.7 Hz, [1.3] 1H, dd, **H-7 [D-1]**), 6.29 (J = 1.6, 3.0 Hz, 1H, dd, **H-7 [D-2]**), 6.19 (J = 2.7 Hz, [1.3] 1H, d,

H-6 [D-1]), 6.15 (J = 3.0 Hz, 1H, d, **H-6 [D-2]**), 4.51 (J = 5.9, 11.2 Hz, [1.3] 1H, dd, **H-5 [D-1]**), 4.37 (J = 3.6, 8.8 Hz, 1H, dd, **H-5 [D-2]**), 3.80 ([1.3] 3H + 3H, s, **H-11 [D-1]** and **H-11 [D-2]**), 3.62 – 3.38 ([1.3] 2H + 2H, m, **H-1 [D-1]** and **H-1 [D-2]**), 3.13 – 3.02 (1H, m, **H-3 [D-2]**), 2.68 – 2.59 ([1.3] 1H, m, **H-3 [D-1]**), 2.29 – 1.79 ([1.3] 4H + 4H, m, **H-2 [D-1]**, **H-1 [D-2]**, **H-4 [D-1]** and **H-4 [D-2]**); $^{13}\text{C-NMR}$ (CDCl_3 , 75 MHz): δ 158.3, 157.1, 156.0, 142.2, 141.8, 136.0, 135.6, 128.7, 128.5, 114.1, 114.1, 110.1, 106.6, 105.4, 66.1, 65.3, 61.1, 60.9, 55.2, 42.6, 42.3, 40.0, 39.4, 38.2, 37.7; *IR*: $\bar{\nu}$ 3347 (O-H), 2933, 1609, 1510, 1301, 1243, 1177, 1146, 1029, 1008, 883, 830, 736, 598, 574; *R_f* (Diethyl ether) 0.35; *Mass Spectrometry*: TOF ES⁺: MNa⁺: Expected: *m/z* 299.1259, Observed: *m/z* 299.1273, Difference = 4.68 ppm

Synthesis of 1-(furan-2-yl)-3-*p*-tolylpentane-1,5-diol (**266d**)

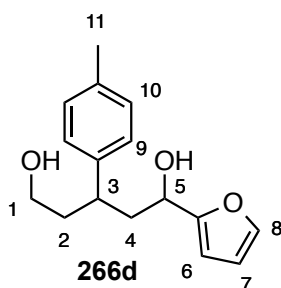

Experimental procedure followed matched that described for **266a** using:

Lithium aluminium hydride (16.4 mg, 0.432 mmol, 12.4 eqv.), methyl-5-(furan-2-yl)-5-oxo-*p*-tolylpentanoate (**270d**) (10.0 mg, 0.0349 mmol, 1.00 eqv.) and THF (5.00 mL). The product was a pale yellow oil.

Diastereomeric Ratio: 1.3:1; *Yield*: 40% (3.60 mg, 0.0138 mmol); $^1\text{H-NMR}$ (CDCl_3 , 300 MHz): δ 7.39 (J = 1.83 Hz, [1.3] 1H, d, **H-8 [D-1]**), 7.32 (J = 1.83 Hz, 1H, d, **H-**

8 [D-2]), 7.13 – 7.03 ([1.3] 4H + 4H, m, H-9 [D-1], H-9 [D-2], H-10 [D-1] and H-10 [D-2]), 6.33 (J = 1.8, 3.1 Hz, [1.3] 1H, dd, H-7 [D-1]), 6.28 (J = 1.8, 3.2 Hz, 1H, dd, H-7 [D-2]), 6.19 (J = 3.1 Hz, [1.3] 1H, d, H-6 [D-1]), 6.15 (J = 3.2 Hz, 1H, d, H-6 [D-2]), 4.51 (J = 4.3, 7.5 Hz, [1.3] 1H, dd, H-5 [D-1]), 4.37 (J = 3.5, 7.6 Hz, 1H, dd, H-5 [D-2]), 3.62 – 3.38 ([1.3] 2H + 2H, m, H-1 [D-1] and H-1 [D-2]), 3.13 – 3.03 (1H, m, H-3 [D-2]), 2.70 – 2.60 ([1.3] 1H, m, H-3 [D-1]), 2.33 ([1.3] 3H + 3H, s, H-11 [D-1] and H-11 [D-2]), 2.29 – 1.75 ([1.3] 2H + 2H, m, H-4 [D-1] and H-4 [D-2]), 2.01 – 1.81 ([1.3] 2H + 2H, m, H-2 [D-1] and H-2 [D-2]); $^{13}\text{C-NMR}$ (CDCl_3 , 75 MHz): δ 157.0, 155.9, 142.1, 141.8, 140.9, 140.5, 136.1, 136.1, 129.4, 127.6, 127.4, 110.1, 110.1, 106.7, 105.4, 66.0, 65.2, 61.1, 60.9, 42.4, 42.0, 39.8, 39.2, 38.5, 38.0, 21.0; *IR*: $\bar{\nu}$ 3317 (O-H), 2924, 1512, 1145, 1042, 1008, 884, 814, 735, 598, 572; *R_f* (Diethyl ether) 0.40; *Mass Spectrometry*: TOF ES⁺: MNa⁺: Expected: *m/z* 283.1310, Observed: *m/z* 283.1320, Difference = 3.53 ppm

Synthesis of 3-(3,4-dimethoxyphenyl)-1-(furan-2-yl)pentane-1,5-diol (266e)

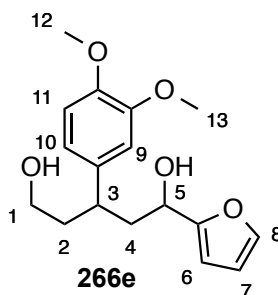

Experimental procedure followed matched that described for **266a** using:

Lithium aluminium hydride (135 mg, 3.56 mmol, 12.3 eqv.), methyl-3-(3,4-dimethoxyphenyl)-5-(furan-2-yl)-5-oxopentanoate (**270e**) (96.0 mg, 0.289 mmol, 1.00 eqv.) and THF (10.0 mL). The product was a pale yellow oil.

Diastereomeric Ratio: 1.3:1; *Yield:* 41% (36.6 mg, 0.119 mmol); $^1\text{H-NMR}$ (CDCl_3 , 300 MHz): δ 7.36 (J = 1.8 Hz, [1.3] 1H, d, H-8 [D-1]), 7.30 (J = 1.8 Hz, 1H, d, H-8 [D-2]), 6.81 – 6.64 ([1.3] 3H + 3H, m, H-9 [D-1], H-9 [D-2], H-10 [D-1], H-10 [D-2], H-11 [D-1] and H-11 [D-2]), 6.31 (J = 1.8, 3.1 Hz, [1.3] 1H, dd, H-7 [D-1]), 6.26 (J = 1.8, 3.2 Hz, 1H, dd, H-7 [D-2]), 6.17 (J = 3.1 Hz, [1.3] 1H, d, H-6 [D-1]), 6.12 (J = 3.2 Hz, 1H, d, H-6 [D-2]), 4.52 (J = 7.2, 7.2 Hz, [1.3] 1H, dd, H-5 [D-1]), 4.36 (J = 2.9, 10.3 Hz, 1H, dd, H-5 [D-2]), 3.84 ([1.3] 3H + 3H, s, H-12 [D-1] and H-12 [D-2]), 3.83 ([1.3] 3H + 3H, s, H-13 [D-1] and H-13 [D-2]), 3.36 – 3.67 ([1.3] 2H + 2H, m, H-1 [D-1] and H-1 [D-2]), 3.10 – 3.00 ([1.3] 1H, m, H-3 [D-1]), 2.70 – 2.61 (1H, m, H-3 [D-2]), 2.26 – 1.84 ([1.3] 4H + 4H, m, H-4 [D-1], H-4 [D-2], H-2 [D-1] and H-2 [D-2]); $^{13}\text{C-NMR}$ (CDCl_3 , 75 MHz): δ 157.0, 156.0, 148.9, 148.9, 147.4, 142.0, 141.7, 136.7, 136.3, 119.7, 119.4, 111.2, 111.2, 110.6, 110.5, 110.1, 110.0, 106.5, 105.3, 65.6, 65.1, 60.7, 55.8, 55.8, 42.4, 41.8, 39.8, 38.7, 38.3, 37.8, 30.2, 29.6; *IR:* $\bar{\nu}$ 3344 (O-H), 2935, 2835, 1513, 1463, 1256, 1232, 1139, 1024, 912, 808, 763, 727, 649, 599; *R_f* (Diethyl ether) 0.21; *Mass Spectrometry:* TOF ES⁺: MNa⁺: Expected: *m/z* 329.1365, Observed: *m/z* 329.1358, Difference = 2.13 ppm

Synthesis of 3-(4-bromophenyl)-1-(furan-2-yl)pentane-1,5-diol (266f)

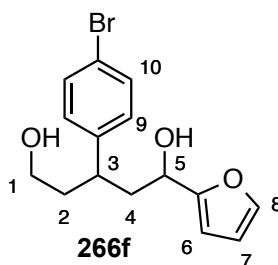

Experimental procedure followed matched that described for **266a** using:

Lithium aluminium hydride (0.141 g, 3.72 mmol, 10.9 eqv.), methyl-3-(4-bromophenyl)-5-(furan-2-yl)-5-oxopentanoate (**270f**) (0.120 g, 0.342 mmol, 1.00 eqv.) and THF (25.0 mL). The product was a milky coloured oil.

Diastereomeric Ratio: 1.3:1; *Yield:* 91% (0.101 g, 0.311 mmol); $^1\text{H-NMR}$ (CDCl_3 , 300 MHz): δ 7.46 – 7.40 ([1.3] 2H + 2H, m, H-9 [D-1] and H-9 [D-2]), 7.39 (J = 1.8 Hz, [1.3] 1H, d, H-8 [D-1]), 7.32 (J = 1.8 Hz, 1H, d, H-8 [D-2]), 7.14 – 7.01 ([1.3] 2H + 2H, m, H-10 [D-1] and H-10 [D-2]), 6.33 (J = 1.8, 3.2 Hz, [1.3] 1H, dd, H-7 [D-1]), 6.29 (J = 1.8, 3.2 Hz, 1H, dd, H-7 [D-2]), 6.18 (J = 3.2 Hz, [1.3] 1H, d, H-6 [D-1]), 6.15 (J = 3.2 Hz, 1H, d, H-6 [D-2]), 4.49 (J = 6.8, 7.8 Hz, [1.3] 1H, dd, H-5 [D-1]), 4.33 (J = 3.2, 10.4 Hz, 1H, dd, H-5 [D-2]), 3.61 – 3.37 ([1.3] 2H + 2H, m, H-1 [D-1] and H-1 [D-2]), 3.18 – 3.08 (1H, m, H-3 [D-2]), 2.74 – 2.66 ([1.3] 1H, m, H-3 [D-1]), 2.32 – 1.71 ([1.3] 4H + 4H, m, H-4 [D-1], H-4 [D-2], H-2 [D-1] and H-2 [D-2]); $^{13}\text{C-NMR}$ (CDCl_3 , 75 MHz): δ 156.7, 155.6, 143.2, 142.8, 142.3, 141.9, 131.7, 131.7, 129.6, 129.3, 120.2, 110.2, 110.1, 106.8, 105.6, 65.7, 65.1, 60.7, 60.5, 42.1, 41.9, 39.6, 38.9, 38.2, 37.9; *IR:* $\bar{\nu}$ 3312 (O-H), 2929, 1486, 1146, 1069, 1042, 1008, 818, 737, 598; *R_f* (Diethyl ether) 0.40; *Mass Spectrometry:* TOF ES⁺: MNa⁺: Expected: *m/z* 347.0259, Observed: *m/z* 347.0245, Difference = -4.03 ppm

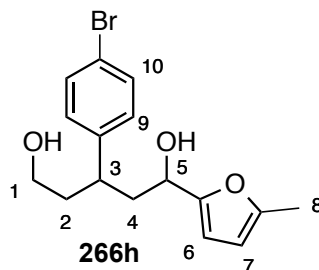
Synthesis of 3-(4-bromophenyl)-1-(5-methylfuran-2-yl)pentane-1,5-diol (266h)

Experimental procedure followed matched that described for **266a** using:

Lithium aluminium hydride (32.3 mg, 0.851 mmol, 10.4 eqv.), methyl-3-(4-bromophenyl)-5-(5-methylfuran-2-yl)-5-oxopentanoate (**270h**) (30.0 mg, 0.0821 mmol, 1.00 eqv.) and THF (15.0 mL). The product was a yellow oil.

Diastereomeric Ratio: 1.4:1; *Yield:* 28% (7.70 mg, 0.0227 mmol); $^1\text{H-NMR}$ (CDCl_3 , 300 MHz): δ 7.45 – 7.40 ([1.4] 2H + 2H, m, H-9 [D-1] and H-9 [D-2]), 7.13 – 7.01 ([1.4] 2H + 2H, m, H-10 [D-1] and H-10 [D-2]), 6.04 (J = 3.0 Hz, [1.4] 1H, d, H-6 [D-1]), 6.01 (J = 3.1 Hz, 1H, d, H-6 [D-2]), 5.89 (J = 1.0, 3.0 Hz, [1.4] 1H, dd, H-7 [D-1]), 5.85 (J = 0.9, 3.1 Hz, 1H, dd, H-7 [D-2]), 4.43 (J = 6.8, 7.7 Hz, [1.4] 1H, dd, H-5 [D-1]), 4.26 (J = 3.3, 10.4 Hz, 1H, dd, H-5 [D-2]), 3.61 – 3.37 ([1.4] 2H + 2H, m, H-1 [D-1] and H-1 [D-2]), 3.16 – 3.05 (1H, m, H-3 [D-2]), 2.77 – 2.66 ([1.4] 1H, m, H-3 [D-1]), 2.28 (J = 1.0 Hz, [1.4] 3H, d, H-8 [D-1]), 2.23 (J = 0.9 Hz, 3H, d, H-8 [D-2]), 2.21 – 1.71 ([1.4] 4H + 4H, m, H-4 [D-1], H-4 [D-2], H-2 [D-1] and H-2 [D-2]); $^{13}\text{C-NMR}$ (CDCl_3 , 75 MHz): δ 154.8, 153.8, 152.0, 151.7, 143.3, 142.9, 131.6, 129.6, 129.3, 120.1, 107.7, 106.5, 106.0, 105.9, 65.7, 65.0, 60.6, 60.5, 41.9, 41.7, 39.6, 38.8, 38.1, 37.9, 13.6, 13.5; *IR:* $\bar{\nu}$ 3309 (O-H), 2920, 1486, 1408, 1218, 1070, 1042, 1020, 1008, 820, 784, 565; *R_f* (Diethyl ether) 0.43; *Mass Spectrometry:* TOF

ES⁺: MNa⁺: Expected: m/z 361.0415, Observed: m/z 361.0427, Difference = 3.32 ppm

Synthesis of 1-(5-methylfuran-2-yl)-3-phenylpentane-1,5-diol (**266i**)

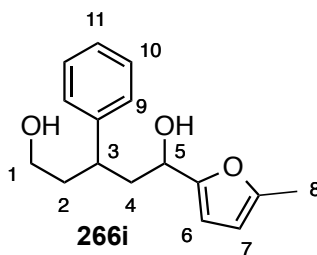

Experimental procedure followed matched that described for **266a** using:

Lithium aluminium hydride (0.144 g, 3.79 mmol, 12.3 eqv.), methyl-5-(5-methylfuran-2-yl)-5-oxo-3-phenylpentanoate (**270i**) (87.9 mg, 0.307 mmol, 1.00 eqv.) and THF (5.50 mL). The product was a yellow oil.

Diastereomeric Ratio: 1.4:1; *Yield:* 73% (58.1 mg, 0.223 mmol); ¹H-NMR (CDCl₃, 300 MHz): δ 7.34 – 7.14 ([1.4] 5H + 5H, m, H-9 [D-1], H-9 [D-2], H-10 [D-1], H-10 [D-2], H-11 [D-1] and H-11 [D-2]), 6.06 (J = 3.1 Hz, [1.4] 1H, d, H-6 [D-1]), 6.01 (J = 3.1 Hz, 1H, d, H-6 [D-2]), 5.90 (J = 0.9, 3.1 Hz, [1.4] 1H, dd, H-7 [D-1]), 5.85 (J = 0.9, 3.1 Hz, 1H, dd, H-7 [D-2]), 4.44 (J = 7.2, 7.2 Hz, [1.4] 1H, dd, H-5 [D-1]), 4.29 (J = 3.3, 10.3 Hz, 1H, dd, H-5 [D-2]), 3.61 – 3.40 ([1.4] 2H + 2H, m, H-1 [D-1] and H-1 [D-2]), 3.02 – 3.19 ([1.4] 1H, m, H-3 [D-1]), 2.65 – 2.79 (1H, m, H-3 [D-2]), 2.28 (J = 0.9 Hz, [1.4] 3H, d, H-8 [D-1]), 2.23 (J = 0.9 Hz, 3H, d, H-8 [D-2]), 2.08 – 1.77 ([1.4] 4H + 4H, m, H-4 [D-1], H-4 [D-2], H-2 [D-1] and H-2 [D-2]); ¹³C-NMR (CDCl₃, 75 MHz): δ 153.9, 152.0, 144.2, 143.8, 128.6, 127.8, 127.6, 126.5, 126.5, 107.6, 106.3, 106.0, 105.9, 65.9, 60.9, 42.2, 41.9, 39.8, 39.0, 38.9, 38.5, 13.6,

13.5; IR: $\bar{\nu}$ 3339 (O-H), 2922, 1699, 1562, 1452, 1219, 1044, 1020, 784, 762, 700; R_f (Diethyl ether) 0.44; Mass Spectrometry: TOF ES⁺: MNa⁺: Expected: m/z 283.1310, Observed: m/z 283.1324, Difference = 4.94 ppm

Synthesis of 1-(5-methylfuran-2-yl)-3-*p*-tolylpentane-1,5-diol (**266j**)

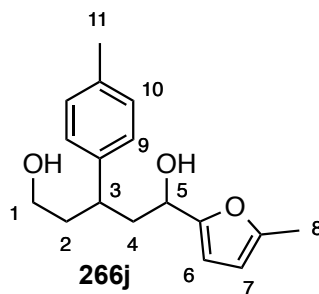

Experimental procedure followed matched that described for **266a** using:

Lithium aluminium hydride (0.117 g, 3.08 mmol, 9.25 eqv.), methyl-5-(5-methylfuran-2-yl)-5-oxo-*p*-tolylpentanoate (**270j**) (0.100 g, 0.333 mmol, 1.00 eqv.) and THF (5.00 mL). The product was a dark yellow oil.

Diastereomeric Ratio: 1.4:1; *Yield*: >99% (90.5 mg, 0.332 mmol); ¹H-NMR (CDCl₃, 400 MHz): δ 7.13 – 7.02 ([1.4] 4H + 4H, m, H-9 [D-1], H-9 [D-2], H-10 [D-1] and H-10 [D-2]), 6.05 (J = 3.0 Hz, [1.4] 1H, d, H-6 [D-1]), 6.01 (J = 3.1 Hz, 1H, d, H-6 [D-2]), 5.89 (J = 0.9, 3.0 Hz, [1.4] 1H, dd, H-7 [D-1]), 5.85 (J = 0.9, 3.1 Hz, 1H, dd, H-7 [D-2]), 4.45 (J = 7.1, 7.1 Hz, [1.4] 1H, dd, H-5 [D-1]), 4.30 (J = 3.1, 10.2 Hz, 1H, dd, H-5 [D-2]), 3.61 – 3.39 ([1.4] 2H + 2H, m, H-1 [D-1] and H-1 [D-2]), 3.12 – 3.01 (1H, m, H-3 [D-2]), 2.78 – 2.63 ([1.4] 1H, m, H-3 [D-1]), 2.32 ([1.4] 3H + 3H, s, H-11 [D-1] and H-11 [D-2]), 2.28 (J = 0.9 Hz, [1.4] 3H, d, H-8 [D-1]), 2.23 (J = 0.9 Hz, 3H, d, H-8 [D-2]), 2.16 – 1.50 ([1.4] 4H + 4H, m, H-2 [D-1], H-2 [D-2], H-4 [D-1] and H-4 [D-2]); ¹³C-NMR (CDCl₃, 100 MHz): δ 155.2, 154.2, 151.9, 151.6, 141.2,

140.7, 136.1, 136.0, 129.4, 127.7, 127.4, 107.5, 106.3, 106.0, 105.9, 66.1, 65.2, 61.2, 61.0, 42.4, 42.1, 39.9, 39.2, 38.7, 38.2, 21.0, 13.6, 13.5; *IR*: $\bar{\nu}$ 3314 (O-H), 2920, 2882, 1513, 1044, 1020, 784, 668, 631, 595, 533, 495; *R_f* (Diethyl ether) 0.50; *Mass Spectrometry*: TOF ES⁺: MNa⁺: Expected: *m/z* 297.1467, Observed: *m/z* 297.1477, Difference = 3.37 ppm

Synthesis of 3-(4-chlorophenyl)-1-(5-methylfuran-2-yl)pentane-1,5-diol (**266k**)

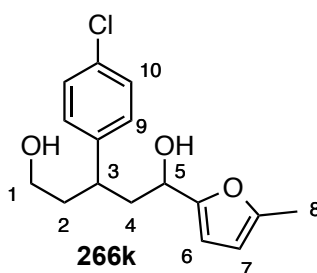

Experimental procedure followed matched that described for **266a** using:

Lithium aluminium hydride (120 mg, 3.16 mmol, 11.2 eqv.), methyl-3-(4-chlorophenyl)-5-(5-methylfuran-2-yl)-5-oxopentanoate (**270k**) (90.0 mg, 0.281 mmol, 1.00 eqv.) and THF (5.00 mL). The product was a yellow oil.

Diastereomeric Ratio: 1.3:1; *Yield*: 69% (56.8 mg, 0.193 mmol); ¹H-NMR (CDCl₃, 300 MHz): δ 7.31 – 7.08 ([1.3] 4H + 4H, m, H-9 [D-1], H-9 [D-2], H-10 [D-1] and H-10 [D-2]), 6.05 (J = 3.1 Hz, [1.3] 1H, d, H-6 [D-1]), 6.01 (J = 3.1 Hz, 1H, d, H-6 [D-2]), 5.90 (J = 1.0, 3.1 Hz, [1.3] 1H, dd, H-7 [D-1]), 5.85 (J = 0.9, 3.1 Hz, 1H, dd, H-7 [D-2]), 4.42 (J = 8.5, 8.5 Hz, [1.3] 1H, dd, H-5 [D-1]), 4.26 (J = 3.1, 13.1 Hz, 1H, dd, H-5 [D-2]), 3.60 – 3.37 ([1.3] 2H + 2H, m, H-1 [D-1] and H-1 [D-2]), 3.05 – 3.19 (1H, m, H-3 [D-2]), 2.64 – 2.81 ([1.3] 1H, m, H-3 [D-1]), 2.28 (J = 1.0 Hz, [1.3] 3H, d, H-8 [D-1]), 2.23 (J = 0.9 Hz, 3H, d, H-8 [D-2]), 2.20 – 1.72 ([1.3] 4H + 4H, m, H-

4 [D-1], H-4 [D-2], H-2 [D-1] and H-2 [D-2]); $^{13}\text{C-NMR}$ (CDCl_3 , 75 MHz): δ 154.9, 153.9, 151.9, 151.6, 142.9, 142.5, 131.9, 129.2, 128.9, 128.6, 107.5, 106.4, 106.0, 105.9, 65.4, 64.9, 60.3, 60.3, 42.0, 41.4, 39.6, 38.4, 37.8, 37.5, 13.5, 13.5; *IR*: $\bar{\nu}$ 3323 (O-H), 2922, 1489, 1219, 1090, 1043, 1013, 826, 784, 566; R_f (Diethyl ether) 0.42; *Mass Spectrometry*: TOF ES^+ : MNa^+ : Expected: m/z 317.0920, Observed: m/z 317.0936, Difference = 5.05 ppm

Synthesis of (2*S*, 4*R*)-2-(furan-2-yl)-4-phenyltetrahydro-2*H*-pyran (**269a**)

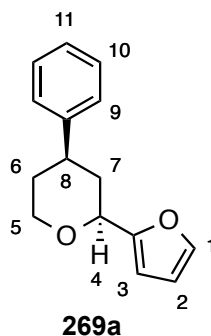

1-(furan-2-yl)-3-phenylpentane-1,5-diol (**266a**) (71.9 mg, 0.292 mmol) was dissolved in acetonitrile (2.00 mL). QuadrapureTM polymer-supported sulfonic acid (11.0 mg) was then added and the reaction was stirred for 3 hours. Upon completion the reaction mixture was filtered and then concentrated under reduced pressure before being characterised. The product was a dark yellow oil.

Yield: 73% (48.4 mg, 0.212 mmol); *Diastereomeric Ratio*: 22:1; $^1\text{H-NMR}$ (CDCl_3 , 300 MHz): δ 7.39 (J = 1.8 Hz, 1H, d, H-1), 7.32 – 7.21 (5H, m, H-9, H-10 and H-11), 6.34 (J = 1.8, 3.3 Hz, 1H, dd, H-2), 6.29 (J = 3.3 Hz, d, H-3), 4.56 (J = 2.6, 11.0 Hz, 1H, dd, H-4), 4.24 (J = 1.8, 4.3, 11.6 Hz, 1H, ddd, H-5), 3.77 (J = 2.8, 11.6, 11.6 Hz, 1H, ddd, H-5), 2.92 (J = 4.3, 4.3, 11.8, 11.8 Hz, 1H, dddd, H-8),

2.12 – 1.82 (4H, m, H-6 and H-7); $^{13}\text{C-NMR}$ (CDCl_3 , 75 MHz): δ 154.6, 145.2, 142.2, 128.6, 126.8, 126.5, 110.1, 106.3, 73.1, 68.6, 41.6, 37.1, 33.1; *IR*: $\bar{\nu}$ 2917, 2846, 1724, 1452, 1252, 1122, 1078, 1012, 943, 808, 739, 698, 599, 532; R_f (9:1 Petroleum ether : Diethyl ether) 0.30; *Mass Spectrometry*: TOF ES^+ : M^+ : Expected: m/z 228.1150, Difference: m/z 228.1142, Difference: -3.51 ppm

Synthesis of (2*R*,4*R*)-2-(furan-2-yl)-4-phenyltetrahydro-2*H*-pyran (**268a**)

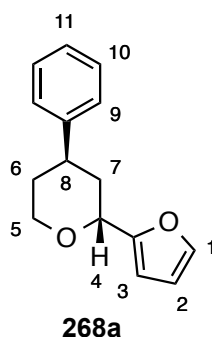

1-(furan-2-yl)-3-phenylpentane-1,5-diol (**266a**) (268 mg, 1.09 mmol, 1.00 eqv.) was dissolved in tetrahydrofuran (10.0 mL) under an inert atmosphere. Sodium hydride (60% in mineral oil) (566 mg, 14.2 mmol, 13.0 eqv.) was then added and the reaction mixture was stirred for 30 minutes at room temperature. 4-toluenesulfonyl chloride (438 mg, 2.30 mmol, 2.11 eqv.) was then added and the reaction was stirred for 12 hours. After, the reaction mixture was quenched with 2M aqueous sodium hydroxide solution (40.0 mL). The reaction mixture was then diluted with ethyl acetate (30.0 mL) and water (30.0 mL). Extraction was performed using ethyl acetate (3 × 30.0 mL) and the combined organic phases were washed with water (2 × 50.0 mL) and brine (50.0 mL). This was then dried over magnesium sulfate and concentrated under reduced pressure. The diastereoisomer mix was then separated by column chromatography using a graduated solvent system reaching

a 19:1 mixture of petroleum ether and diethyl ether. The product was a colourless oil.

Yield: 7% (18.6 mg, 0.0815 mmol); $^1\text{H-NMR}$ (CDCl_3 , 300 MHz): δ 7.45 (J = 1.8 Hz, 1H, d, H-1), 7.38 – 7.21 (5H, m, H-9, H-10 and H-11), 6.41 (J = 1.8, 3.2 Hz, 1H, dd, H-2), 6.37 (J = 3.2 Hz, d, H-3), 5.09 (J = 2.7, 5.3 Hz, 1H, dd, H-4), 3.87 (J = 3.8, 3.9, 11.6 Hz, 1H, ddd, H-5), 3.73 (J = 2.9, 10.8, 11.6 Hz, 1H, ddd, H-5), 3.13 (J = 4.1, 4.1, 11.0, 11.0 Hz, 1H, dddd, H-8), 2.33 (J = 2.7, 4.1, 13.7 Hz, 1H, ddd, H-7), 2.19 (J = 5.3, 11.0, 13.7 Hz, 1H, ddd, H-7), 1.94 (J = 4.1, 10.8, 11.1, 13.4 Hz, 1H, dddd, H-6), 1.86 – 1.78 (1H, m, H-6); $^{13}\text{C-NMR}$ (CDCl_3 , 75 MHz): δ 154.1, 145.2, 142.1, 128.6, 126.9, 126.3, 110.2, 108.0, 69.1, 62.7, 36.4, 34.1, 32.9; *IR:* $\bar{\nu}$ 2959, 2948, 2926, 2897, 2873, 1497, 1452, 1341, 1181, 1146, 1080, 1005, 768, 761, 700, 599, 534, 443; *R_f* (Diethyl ether) 0.93; *Mass Spectrometry:* TOF ES⁺: M⁺: Expected: *m/z* 228.1150, Observed: *m/z* 228.1151, Difference = 0.44 ppm

Synthesis of (2*S*,4*R*)-4-(4-chlorophenyl)-2-(furan-2-yl)tetrahydro-2*H*-pyran (**269b**)

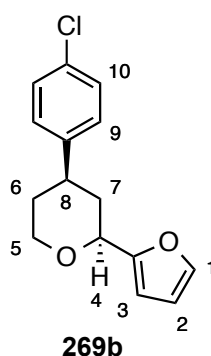

Experimental procedure followed matched that described for **269a** using:

3-(4-chlorophenyl)-1-(furan-2-yl)pentan-1,5-diol (**266b**) (25.0 mg, 0.0890 mmol), Quadrapure™ polymer-supported sulfonic acid (10.2 mg) and acetonitrile (2.50 mL). The product was a pale yellow oil.

Yield: 23% (5.30 mg, 0.0202 mmol); *Diastereomeric Ratio:* 19:1; $^1\text{H-NMR}$ (CDCl_3 , 300 MHz): δ 7.39 (J = 1.8 Hz, 1H, d, H-1), 7.32 – 7.28 (2H, m, H-10), 7.21 – 7.17 (2H, m, H-9), 6.34 (J = 1.8, 3.2 Hz, 1H, dd, H-2), 6.29 (J = 3.2 Hz, 1H, d, H-3), 4.54 (J = 2.5, 11.1 Hz, 1H, dd, H-4), 4.23 (J = 2.1, 4.1, 11.6 Hz, 1H, ddd, H-5), 3.75 (J = 3.2, 11.5, 11.6 Hz, 1H, ddd, H-5), 2.90 (J = 4.4, 4.4, 11.4, 11.4 Hz, 1H, dddd, H-8), 2.13 – 1.76 (4H, m, H-6 and H-7); $^{13}\text{C-NMR}$ (CDCl_3 , 75 MHz): δ 154.4, 143.6, 142.2, 132.1, 128.7, 128.1, 110.1, 106.4, 73.0, 68.4, 41.0, 37.0, 33.0; *IR:* $\bar{\nu}$ 2917, 2844, 1491, 1169, 1078, 1012, 877, 824, 803, 736, 599, 536, 435; *R_f* (9:1 Petroleum ether : Diethyl ether) 0.27; *Mass Spectrometry:* TOF ES⁺: M⁺: Expected: *m/z* 262.0761, Observed: *m/z* 262.0771, Difference = 3.82 ppm

Synthesis of (2S,4R)-2-(furan-2-yl)-4-(4-methoxyphenyl)tetrahydro-2H-pyran (**269c**)

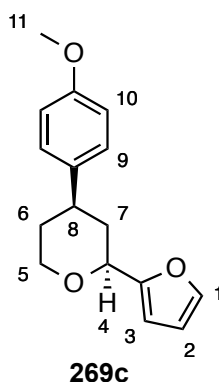

Experimental procedure followed matched that described for **269a** using:

1-(furan-2-yl)-3-(4-methoxyphenyl)pentane-1,5-diol (**266c**) (33.0 mg, 0.119 mmol), Quadrapure™ polymer-supported sulfonic acid (23.8 mg) and acetonitrile (5.04 mL). The product was a yellow oil.

Yield: 59% (18.2 mg, 0.0705 mmol); *Diastereomeric Ratio:* 10:1; $^1\text{H-NMR}$ (CDCl_3 , 300 MHz): δ 7.39 (J = 1.8 Hz, 1H, d, H-1), 7.21 – 7.17 (2H, m, H-9), 6.91 – 6.86 (2H, m, H-10), 6.34 (J = 1.8, 3.3 Hz, 1H, dd, H-2), 6.29 (J = 3.3 Hz, 1H, d, H-3), 4.55 (J = 2.4, 11.1 Hz, 1H, dd, H-4), 4.23 (J = 1.9, 4.2, 11.5 Hz, 1H, ddd, H-5), 3.80 (3H, s, H-11), 3.76 – 3.71 (1H, m, H-5), 2.92 – 2.81 (1H, m, H-8), 2.13 – 1.80 (4H, m, H-6 and H-7); $^{13}\text{C-NMR}$ (CDCl_3 , 75 MHz): δ 158.1, 154.6, 142.2, 137.4, 127.6, 113.9, 110.0, 106.3, 73.0, 68.6, 55.2, 40.7, 37.3, 33.3; *IR:* $\bar{\nu}$ 2919, 2837, 1583, 1245, 1178, 1078, 1034, 1011, 828, 806, 736, 599, 547, 531; *R_f* (9:1 Petroleum ether : Diethyl ether) 0.25; *Mass Spectrometry:* TOF ES⁺: M⁺: Expected: *m/z* 258.1256, Observed: *m/z* 258.1244, Difference = -4.65 ppm

Synthesis of (2S,4R)-2-(furan-2-yl)-4-p-tolyltetrahydro-2H-pyran (**269d**)

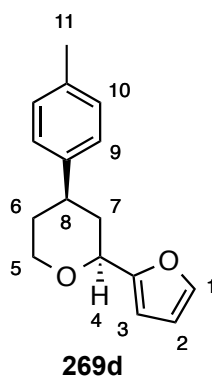

Experimental procedure followed matched that described for **269a** using:

1-(furan-2-yl)-3-*p*-tolylpentane-1,5-diol (**266d**) (3.00 mg, 0.0115 mmol), Quadrapure™ polymer-supported sulfonic acid (10.0 mg) and acetonitrile (0.750 mL). The product was a pale yellow oil.

Yield: 83% (2.30 mg, 0.00949 mmol); *Diastereomeric Ratio*: 20:1; $^1\text{H-NMR}$ (CDCl_3 , 300 MHz): δ 7.48 (J = 1.8 Hz, 1H, d, H-1), 7.26 (4H, m, H-9 and H-10), 6.43 (J = 1.8, 3.2 Hz, 1H, dd, H-2), 6.39 (J = 3.2 Hz, 1H, d, H-3), 4.64 (J = 2.4, 11.0 Hz, 1H, dd, H-4), 4.33 (J = 1.4, 4.3, 11.5 Hz, 1H, ddd, H-5), 3.83 (J = 2.6, 11.5, 11.6 Hz, 1H, ddd, H-5), 2.96 (J = 4.2, 4.2, 11.7, 11.7 Hz, 1H, dddd, H-8), 2.44 (3H, s, H-11), 2.25 – 2.05 (2H, m, H-7), 2.04 – 1.83 (2H, m, H-6); $^{13}\text{C-NMR}$ (CDCl_3 , 75 MHz): δ 154.5, 142.0, 141.9, 135.7, 129.0, 126.4, 109.8, 106.0, 72.8, 68.3, 40.8, 37.0, 33.0, 20.7; *IR*: $\bar{\nu}$ 3109, 2916, 2847, 1514, 1440, 1373, 1349, 1251, 1226, 1039, 1011, 998, 910, 804, 734, 541, 505; R_f (Diethyl ether) 0.90; *Mass Spectrometry*: TOF EI⁺: M⁺: Expected: m/z 258.1256, Observed: m/z 258.1244, Difference: -4.65 ppm

Synthesis of (2*S*,4*R*)-4-(3,4-dimethoxyphenyl)-2-(furan-2-yl)tetrahydro-2H-pyran (269e)

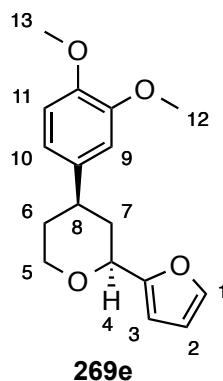

Experimental procedure followed matched that described for **269a** using:

3-(3,4-dimethoxyphenyl)-1-(furan-2-yl)pentane-1,5-diol (**266e**) (3.00 mg, 0.00979 mmol), Quadrapure™ polymer-supported sulfonic acid (7.40 mg) and acetonitrile (0.750 mL). The product was a pale brown solid.

Yield: 82% (2.30 mg, 0.00798 mmol); *Diastereomeric Ratio:* 15:1; $^1\text{H-NMR}$ (CDCl_3 , 300 MHz): δ 7.39 (J = 1.8 Hz, 1H, dd, H-1), 6.86 – 6.79 (3H, m, H-9, H-10 and H-11), 6.34 (J = 1.8, 3.3 Hz, 1H, dd, H-2), 6.29 (J = 3.3 Hz, 1H, d, H-3), 4.54 (J = 2.4, 11.1 Hz, 1H, dd, H-4), 4.24 (J = 1.9, 4.2, 11.5 Hz, 1H, ddd, H-5), 3.89 (3H, s, H-13), 3.87 (3H, s, H-12), 3.75 (J = 3.4, 11.5, 11.5 Hz, 1H, ddd, H-5), 2.87 (J = 4.3, 4.3, 11.6, 11.6 Hz, 1H, dddd, H-8), 2.14 – 1.78 (4H, m, H-6 and H-7); $^{13}\text{C-NMR}$ (CDCl_3 , 75 MHz): δ 154.6, 148.9, 147.5, 142.2, 137.9, 118.4, 111.2, 110.1, 110.0, 106.3, 73.1, 68.6, 55.9, 55.8, 41.2, 37.4, 33.3; *IR:* $\bar{\nu}$ 2933, 2835, 1515, 1463, 1259, 1242, 1142, 1120, 1078, 1026, 1013, 912, 882, 808, 764, 729, 638, 599, 541, 493, 460; *Melting Point:* 88 – 89 °C; *R_f* (Diethyl ether) 0.85; *Mass Spectrometry:* TOF ES⁺: M⁺: Expected: *m/z* 288.1362, Observed: *m/z* 288.1359, Difference = –1.04 ppm

Synthesis of (2S,4R)-4-(4-bromophenyl)-2-(furan-2-yl)tetrahydro-2H-pyran (**269f**)

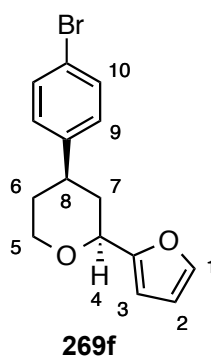

Experimental procedure followed matched that described for **269a** using:

3-(4-bromophenyl)-1-(furan-2-yl)pentane-1,5-diol (**266f**) (88.4 mg, 0.272 mmol), Quadrapure™ polymer-supported sulfonic acid (23.9 mg) and acetonitrile (6.50 mL). The product was a brown oil.

Yield: 96% (80.1 mg, 0.261 mmol); *Diastereomeric Ratio:* 10:1; $^1\text{H-NMR}$ (CDCl_3 , 300 MHz): δ 7.48 – 7.43 (2H, m, H-9), 7.40 (J = 1.8 Hz, 1H, dd, H-1), 7.16 – 7.12 (2H, m, H-10), 6.35 (J = 1.8, 3.3 Hz, 1H, dd, H-2), 6.30 (J = 3.3 Hz, 1H, d, H-3), 4.55 (J = 2.4, 11.0 Hz, 1H, dd, H-4), 4.24 (J = 2.0, 4.1, 11.5 Hz, 1H, ddd, H-5), 3.75 (J = 3.7, 11.5, 11.5 Hz, 1H, ddd, H-5), 2.88 (J = 4.3, 4.3, 11.5, 11.5 Hz, 1H, dddd, H-8), 2.13 – 1.76 (4H, m, H-6 and H-7); $^{13}\text{C-NMR}$ (CDCl_3 , 75 MHz): δ 154.4, 144.1, 142.2, 131.6, 128.5, 120.2, 110.1, 106.4, 73.0, 68.4, 41.1, 36.9, 33.0; *IR:* $\bar{\nu}$ 2917, 2846, 1488, 1075, 1044, 1008, 911, 820, 732, 599, 534; *R_f* (9:1 Petroleum ether : Diethyl ether) 0.27; *Mass Spectrometry:* TOF ES⁺: M⁺: Expected: *m/z* 306.0255, Observed: *m/z* 306.0268, Difference = 4.25 ppm

Synthesis of (2S,4R)-4-(4-bromophenyl)-2-(5-methylfuran-2-yl)tetrahydro-2H-pyran (**269h**)

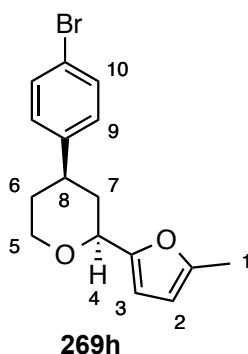

Experimental procedure followed matched that described for **269a** using:

3-(4-bromophenyl)-1-(5-methylfuran-2-yl)pentane-1,5-diol (**266h**) (10.0 mg, 0.0295 mmol), Quadrapure™ polymer-supported sulfonic acid (21.0 mg) and acetonitrile (1.50 mL). The product was a pale yellow oil.

Yield: 70% (6.60 mg, 0.0205 mmol); *Diastereomeric Ratio*: 22:1; $^1\text{H-NMR}$ (CDCl_3 , 300 MHz): δ 7.47 – 7.42 (2H, m, H-9), 7.16 – 7.12 (2H, m, H-10), 6.16 (J = 3.1 Hz, 1H, d, H-3), 5.91 (J = 0.9, 3.1 Hz, 1H, dd, H-2), 4.47 (J = 2.8, 10.7 Hz, 1H, dd, H-4), 4.23 (J = 2.0, 4.2, 11.56 Hz, 1H, ddd, H-5), 3.74 (J = 3.5, 11.5, 11.6 Hz, ddd, H-5), 2.87 (J = 4.6, 4.6, 11.3, 11.3 Hz, 1H, dddd, H-8), 2.29 (J = 0.9 Hz, 3H, d, H-1), 2.08 – 1.75 (4H, m, H-6 and H-7); $^{13}\text{C-NMR}$ (CDCl_3 , 75 MHz): δ 152.6, 152.1, 144.2, 131.6, 128.5, 120.1, 107.4, 106.0, 73.0, 68.4, 41.2, 36.8, 33.0, 13.6; *IR*: $\bar{\nu}$ 2940, 2918, 2856, 1570, 1488, 1440, 1345, 1218, 1084, 1074, 1038, 1006, 957, 909, 808, 794, 770, 666, 556, 534, 516, 501; R_f (9:1 Petroleum ether : Diethyl ether) 0.24; *Mass Spectrometry*: TOF ES^+ : M^+ : Expected: m/z 320.0412, Observed: m/z 320.0403, Difference = -2.81 ppm

Synthesis of (2*S*,4*R*)-2-(5-methylfuran-2-yl)-4-phenyltetrahydro-2*H*-pyran (**269i**)

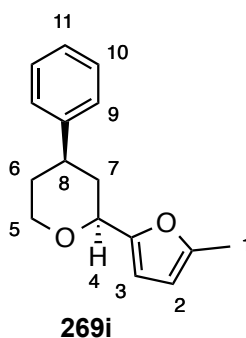

Experimental procedure followed matched that described for **269a** using:

1-(5-methylfuran-2-yl)-3-phenylpentane-1,5-diol (**266i**) (53.0 mg, 0.204 mmol), Quadrapure™ polymer-supported sulfonic acid (14.4 mg) and acetonitrile (2.50 mL). The product was a yellow oil.

Yield: 83% (41.1 mg, 0.170 mmol); *Diastereomeric Ratio:* 20:1; $^1\text{H-NMR}$ (CDCl_3 , 300 MHz): δ 7.35 – 7.18 (5H, m, H-9, H-10 and H-11), 6.15 (J = 3.1 Hz, 1H, d, H-3), 5.89 (J = 0.9, 3.1 Hz, 1H, dd, H-2), 4.47 (J = 3.2, 10.3 Hz, 1H, dd, H-4), 4.22 (J = 1.7, 4.4, 11.6 Hz, 1H, ddd, H-5), 3.73 (J = 2.7, 11.6, 11.7 Hz, 1H, ddd, H-5), 2.88 (J = 4.5, 4.5, 11.7, 11.7 Hz, 1H, dddd, H-8), 2.27 (J = 0.9 Hz, 3H, d, H-1), 2.10 – 1.74 (4H, m, H-6 and H-7); $^{13}\text{C-NMR}$ (CDCl_3 , 75 MHz): δ 152.8, 152.0, 145.3, 128.6, 126.8, 126.5, 107.3, 105.9, 73.1, 68.5, 41.7, 36.9, 33.1, 13.6; *IR:* $\bar{\nu}$ 2920, 2848, 1452, 1374, 1220, 1078, 1012, 907, 786, 727, 698, 647, 548, 532; *R_f* (9:1 Petroleum ether : Diethyl ether) 0.33; *Mass Spectrometry:* TOF EI^+ : M^+ : Expected: m/z 242.1307, Observed: m/z 242.1297, Difference = 4.13 ppm

Synthesis of (2S,4R)-2-(5-methylfuran-2-yl)-4-p-tolyltetrahydro-2H-pyran (**269j**)

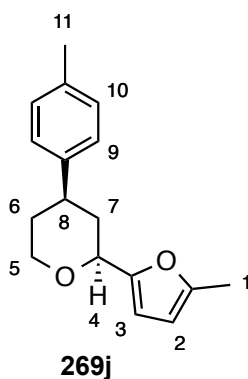

Experimental procedure followed matched that described for **269a** using:

1-(5-methylfuran-2-yl)-3-*p*-tolylpentane-1,5-diol (**266j**) (35.0 mg, 0.129 mmol), Quadrapure™ polymer-supported sulfonic acid (25.3 mg) and acetonitrile (1.50 mL). The product was a orange/brown oil.

Yield: 85% (28.0 mg, 0.109 mmol); *Diastereomeric Ratio*: 15:1; $^1\text{H-NMR}$ (CDCl_3 , 300 MHz): δ 7.19 – 7.15 (4H, m, H-9 and H-10), 6.17 (J = 3.1 Hz, 1H, d, H-3), 5.91 (J = 1.0, 3.1 Hz, 1H, dd, H-2), 4.49 (J = 3.0, 10.5 Hz, 1H, dd, H-4), 4.24 (J = 1.7, 4.3, 11.6 Hz, 1H, ddd, H-5), 3.75 (J = 2.8, 11.6, 11.6 Hz, 1H, ddd, H-5), 2.88 (J = 4.5, 4.5, 11.7, 11.65 Hz, 1H, dddd, H-8), 2.35 (3H, s, H-11), 2.30 (J = 1.0 Hz, 3H, d, H-1), 2.09 – 1.79 (4H, m, H-6 and H-7); $^{13}\text{C-NMR}$ (CDCl_3 , 75 MHz): δ 152.9, 152.0, 142.3, 136.0, 129.2, 126.6, 107.3, 105.9, 73.1, 68.5, 41.2, 37.0, 33.2, 21.0, 13.6; *IR*: $\bar{\nu}$ 2919, 2847, 1515, 1441, 1372, 1221, 1077, 1049, 1011, 964, 911, 814, 781, 540; *R_f* (9:1 Petroleum ether : Diethyl ether) 0.32; *Mass Spectrometry*: TOF ES⁺: M⁺: Expected: *m/z* 256.1463, Observed: *m/z* 256.1457, Difference = -2.34 ppm

Synthesis of (2S,4R)-4-(4-chlorophenyl)-2-(5-methylfuran-2-yl)tetrahydro-2H-pyran (269k)

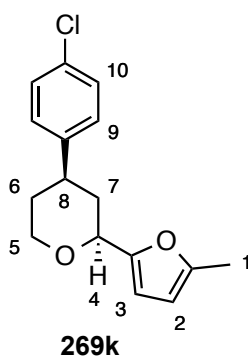

Experimental procedure followed matched that described for **269a** using:

3-(4-chlorophenyl)-1-(5-methylfuran-2-yl)pentane-1,5-diol (**266k**) (49.0 mg, 0.166 mmol), Quadrapure™ polymer-supported sulfonic acid (22.0 mg) and acetonitrile (2.00 mL). The product was a yellow oil.

Yield: 68% (31.1 mg, 0.112 mmol); *Diastereomeric Ratio:* 10:1; $^1\text{H-NMR}$ (CDCl_3 , 300 MHz): δ 7.31 – 7.28 (2H, m, H-10), 7.21 – 7.17 (2H, m, H-9), 6.16 (J = 3.1 Hz, 1H, d, H-3), 5.91 (J = 0.8, 3.1 Hz, 1H, dd, H-2), 4.48 (J = 2.9, 10.6 Hz, 1H, dd, H-4), 4.23 (J = 1.9, 4.1, 11.5 Hz, 1H, ddd, H-5), 3.74 (J = 3.0, 11.4, 11.5 Hz, 1H, ddd, H-5), 2.88 (J = 4.6, 4.6, 11.4, 11.4 Hz, 1H, dddd, H-8), 2.29 (J = 0.8 Hz, 3H, d, H-1), 2.04 – 1.79 (4H, m, H-6 and H-7); $^{13}\text{C-NMR}$ (CDCl_3 , 75 MHz): δ 152.6, 152.1, 143.7, 132.1, 128.7, 128.1, 107.4, 106.0, 73.0, 68.4, 41.1, 36.9, 33.0, 13.6; *IR:* $\bar{\nu}$ 2942, 2917, 2842, 1492, 1221, 1124, 1084, 1050, 1012, 965, 826, 787, 635, 536, 436; *R_f* (9:1 Petroleum ether : Diethyl ether) 0.26; *Mass Spectrometry:* TOF ES⁺: M⁺: Expected: *m/z* 276.0917, Observed: *m/z* 276.0905, Difference = -4.35 ppm

5.5. Data for Compounds Synthesised in the Formation of 2,4,5-Trisubstituted Tetrahydropyrans

Synthesis of 3-(4-chlorophenyl)-1-(furan-2-yl)-4-(hydroxymethyl)pentane-1,5-diol **(287b)**

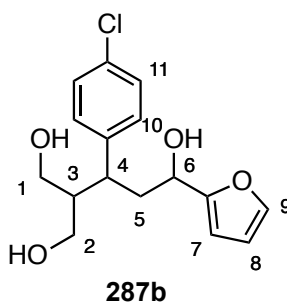

Lithium aluminium hydride (0.368 g, 9.70 mmol, 10.6 eqv.) was dissolved in tetrahydrofuran (15.0 mL). This was then cooled to -15°C and dimethyl-2-(1-(4-chlorophenyl)-3-(furan-2-yl)-3-oxopropyl)malonate (**271b**) (0.303 g, 0.917 mmol, 1.00 eqv.) in THF (10.0 mL) was added. The reaction was stirred at room temperature for 30 minutes. After this, the reaction was quenched by the addition of diethyl ether (20.0 mL), followed by a 4:1 mixture of diethyl ether and acetone (20.0 mL) at -15°C . The reaction mixture was then diluted with ethyl acetate (60.0 mL), water (150 mL) and 2M aqueous sodium hydroxide solution (200 mL). Extraction was completed using ethyl acetate (3×60.0 mL). The combined organic phases were washed with water (2×100 mL) and brine (100 mL). This was then dried over magnesium sulfate, concentrated under reduced pressure and purified *via* column chromatography using a graduated solvent system reaching a 95:5 mixture of dichloromethane and methanol. The product was analysed by ^1H -NMR and during the NMR analysis some solid crashed out. The white solid was

enriched in one diastereoisomer whilst the pale yellow liquid was enriched in the other. Data was collected on both states; however the solid didn't dissolve in *d*-chloroform and so *d*₃-acetonitrile was used instead.

Yield: 47% (94.3 mg, 0.303 mmol)

anti-**293b** (Crystal)

¹*H-NMR* (CD₃CN, 400 MHz): δ 7.35 (J = 1.8 Hz, 1H, d, H-9), 7.34 – 7.31 (2H, m, H-10), 7.24 – 7.20 (2H, m, H-11), 6.30 (J = 1.8, 3.2 Hz, 1H, dd, H-8), 6.13 (J = 3.2 Hz, 1H, d, H-7), 4.06 (J = 2.8, 5.1, 10.7 Hz, 1H, ddd, H-6), 3.71 – 3.65 (2H, m, H-1), 3.31 – 3.24 (2H, m, H-2), 3.11 (J = 3.5, 8.8, 12.6 Hz, 1H, ddd, H-4), 2.90 (J = 5.1 Hz, 1H, d, OH), 2.79 (J = 5.1, 5.1 Hz, 1H, dd, OH), 2.25 (J = 3.5, 10.7, 14.2 Hz, 1H, ddd, H-5), 1.99 (J = 2.8, 12.6, 14.2 Hz, 1H, ddd, H-5), 1.78 (1H, m, H-3); ¹³*C-NMR* (CD₃CN, 100 MHz): δ 159.0, 143.0, 142.5, 132.1, 131.2, 129.0, 110.9, 105.8, 65.1, 62.8, 62.1, 48.4, 40.0, 39.4

syn-**293b** (Oil)

¹*H-NMR* (CD₃CN, 400 MHz): δ 7.42 (J = 1.8 Hz, 1H, d, H-9), 7.31 – 7.29 (2H, m, H-10), 7.12 – 7.07 (2H, m, H-11), 6.36 (J = 1.8, 3.2 Hz, 1H, dd, H-8), 6.18, (J = 3.2 Hz, 1H, d, H-7), 4.15 (J = 5.1, 5.3, 9.9 Hz, 1H, ddd, H-6), 3.78 – 3.71 (2H, m, H-1), 3.42 – 3.32 (1H, m, H-2), 3.28 (J = 5.3 Hz, 1H, d, OH), 3.14 (J = 5.1, 5.4, 14.5 Hz, 1H, ddd, H-2), 2.90 (J = 5.1, 5.1 Hz, 1H, dd, OH), 2.69 (J = 5.1, 5.1 Hz, 1H, dd, OH), 2.58 (J = 4.1, 8.8, 11.1 Hz, 1H, ddd, H-4), 2.43 (J = 4.1, 9.9, 13.6 Hz, 1H, ddd, H-5), 2.09 (J = 5.1, 11.1, 13.6 Hz, 1H, ddd, H-5), 1.78 (1H, m, H-3); ¹³*C-NMR*

(CD₃CN, 100 MHz): δ 157.3, 143.1, 142.9, 132.1, 130.9, 129.0, 110.9, 107.4, 66.1, 62.4, 62.1, 48.2, 40.4, 39.4

IR: $\bar{\nu}$ 3363 (O-H), 3212 (O-H), 2932, 2897, 1453, 1412, 1082, 1048, 1013, 996, 966, 875, 847, 815, 739, 638, 617, 598, 543; *R_f* (ethyl acetate) 0.44; *Mass Spectrometry*: TOF ES⁺: MNa⁺: Expected: *m/z* 333.0860, Observed: *m/z* 333.0870, Difference = 3.00 ppm

Synthesis of 1-(furan-2-yl)-4-(hydroxymethyl)-3-(4-methoxyphenyl)pentane-1,5-diol
(287c)

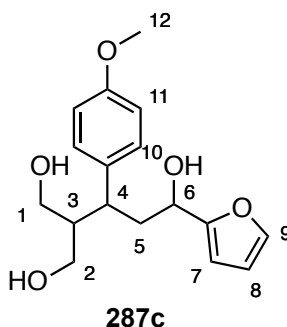

Experimental procedure followed matched that described for **287b** using:

Lithium aluminium hydride (0.217 g, 5.72 mmol, 9.91 eqv.), dimethyl-2-(3-(furan-2-yl)-1-(4-methoxyphenyl)-3-oxopropyl)malonate (**271c**) (0.208 g, 0.577 mmol, 1.00 eqv.) and THF (25.0 mL). The product was a pale yellow oil.

Diastereomeric Ratio: 1.7:1; *Yield*: 33% (58.4 mg, 0.191 mmol); ¹H-NMR (CDCl₃, 300 MHz): δ 7.33 (J = 1.5 Hz, [1.7] 1H, d, H-9 [D-1]), 7.26 (J = 1.7 Hz, 1H, d, H-9 [D-2]), 7.11 – 6.78 ([1.7] 4H + 4H, m, H-10 [D-1], H-10 [D-2], H-11 [D-1] and H-11 [D-2]), 6.28 (J = 1.5, 3.2 Hz, [1.7] 1H, dd, H-8 [D-1]), 6.23 (J = 1.7, 3.2 Hz, 1H, dd,

H-8 [D-2]), 6.13 (J = 3.2 Hz, [1.7] 1H, d, H-7 [D-1]), 6.06 (J = 3.2 Hz, 1H, d, H-7 [D-2]), 4.33 (J = 5.3, 8.8 Hz, [1.7] 1H, dd, H-6 [D-1]), 4.20 (J = 1.5, 10.9 Hz, 1H, dd, H-6 [D-2]), 3.92 – 3.71 ([1.7] 2H + 2H, m, H-2 [D-1] and H-2 [D-2]), 3.76 ([1.7] 3H + 3H, s, H-12 [D-1] and H-12 [D-2]), 3.58 – 3.01 ([1.7] 6H + 6H, m, H-1 [D-1], H-1 [D-2], H-4 [D-1], H-4 [D-2], OH [D-1], OH [D-2], OH [D-1], OH [D-2], OH [D-1] and OH [D-2]), 2.54 – 1.70 ([1.7] 3H + 3H, m, H-3 [D-1], H-3 [D-2], H-5 [D-1] and H-5 [D-2]); $^{13}\text{C-NMR}$ (CDCl_3 , 75 MHz): δ 158.1, 157.1, 155.4, 142.1, 141.6, 134.2, 134.2, 129.2, 128.9, 114.0, 113.9, 110.1, 110.0, 107.1, 105.2, 66.0, 64.9, 63.8, 63.6, 62.6, 55.2, 50.6, 46.7, 39.3, 38.7, 38.1; *IR*: $\bar{\nu}$ 3311 (O-H), 2944, 2887, 2384, 1609, 1509, 1440, 1301, 1244, 1177, 1146, 1008, 828, 736, 598, 556; R_f (ethyl acetate) 0.33; *Mass Spectrometry*: TOF ES^+ : MNa^+ : Expected: m/z 329.1365, Observed: m/z 329.1361, Difference = -1.22 ppm

Synthesis of 1-(furan-2-yl)-4-(hydroxymethyl)-3-*p*-tolylpentane-1,5-diol (**287d**)

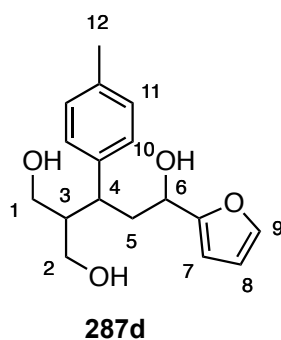

Experimental procedure followed matched that described for **287b** using:

Lithium aluminium hydride (0.340 g, 8.96 mmol, 9.18 eqv.), dimethyl-2-(3-(furan-2-yl)-3-oxo-1-*p*-tolylpropyl)malonate (**271d**) (0.336 g, 0.976 mmol, 1.00 eqv.) and THF (25.0 mL). The product was a pale yellow oil.

Diastereomeric Ratio: 1.3:1; *Yield:* 27% (76.6 mg, 0.264 mmol); $^1\text{H-NMR}$ (CDCl_3 , 300 MHz): δ 7.31 (J = 1.8 Hz, [1.3] 1H, d, H-9 [D-1]), 7.24 (J = 1.8 Hz, 1H, d, H-9 [D-2]), 7.09 – 6.90 ([1.3] 4H + 4H, m, H-10 [D-1], H-10 [D-2], H-11 [D-1] and H-11 [D-2]), 6.27 (J = 1.8, 3.1 Hz, [1.3] 1H, dd, H-8 [D-1]), 6.22 (J = 1.8, 3.2 Hz, 1H, dd, H-8 [D-2]), 6.12 (J = 3.1 Hz, [1.3] 1H, d, H-7 [D-1]), 6.04 (J = 3.2 Hz, 1H, d, H-7 [D-2]), 4.33 (J = 5.4, 8.8 Hz, [1.3] 1H, dd, H-6 [D-1]), 4.18 (J = 1.4, 10.8 Hz, 1H, dd, H-6 [D-2]), 3.90 – 3.00 ([1.3] 7H + 7H, m, H-4 [D-1], H-4 [D-2], H-1 [D-1], H-1 [D-2], H-2 [D-1], H-2 [D-2], OH [D-1], OH [D-2], OH [D-1] and OH [D-2]), 2.54 – 1.70 ([1.3] 4H + 4H, m, H-5 [D-1], H-5 [D-2], H-3 [D-1], H-3 [D-2], OH [D-1] and OH [D-2]), 2.30 ([1.3] 3H + 3H, s, H-12 [D-1] and H-12 [D-2]); $^{13}\text{C-NMR}$ (CDCl_3 , 75 MHz): δ 157.2, 155.4, 142.1, 141.5, 139.2, 139.1, 136.0, 135.9, 129.3, 129.2, 128.1, 127.9, 110.0, 110.0, 107.0, 105.2, 65.9, 64.9, 63.6, 63.6, 63.4, 62.2, 46.7, 46.6, 39.8, 38.6, 38.5, 21.0; *IR:* $\bar{\nu}$ 3317 (O-H), 2922, 2889, 1512, 1434, 1147, 1010, 909, 814, 731, 632, 599, 533, 494; *R_f* (ethyl acetate) 0.32; *Mass Spectrometry:* TOF ES⁺: MNa⁺: Expected: *m/z* 313.1416, Observed: *m/z* 313.1407, Difference = -2.87 ppm

Synthesis of 3-(3,4-dimethoxyphenyl)-1-(furan-2-yl)-4-(hydroxymethyl)pentane-1,5-diol (287e)

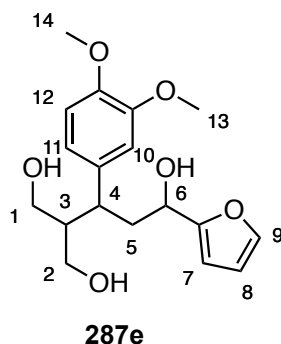

Experimental procedure followed matched that described for **287b** using:

Lithium aluminium hydride (0.246 g, 6.48 mmol, 12.2 eqv.), dimethyl-2-(1-(3,4-dimethoxyphenyl)-3-(furan-2-yl)-3-oxopropyl)malonate (**271e**) (0.207 g, 0.530 mmol, 1.00 eqv.) and THF (25.0 mL). The product was a pale yellow oil.

Diastereomeric Ratio: 1:1; *Yield:* 15% (27.2 mg, 0.0809 mmol); $^1\text{H-NMR}$ (CDCl_3 , 300 MHz): δ 7.33 (J = 1.5 Hz, 1H, d, H-9 [D-1]), 7.26 (J = 1.6 Hz, 1H, d, H-9 [D-2]), 6.79 – 6.71 (3H, m, H-10 [D-1], H-11 [D-1] and H-12 [D-1]), 6.60 – 6.54 (3H, m, H-10 [D-2], H-11 [D-2] and H-12 [D-2]), 6.29 (J = 1.5, 3.1 Hz, 1H, dd, H-8 [D-1]), 6.24 (J = 1.6, 3.2 Hz, 1H, dd, H-8 [D-2]), 6.15 (J = 3.1 Hz, 1H, d, H-7 [D-1]), 6.07 (J = 3.2 Hz, 1H, d, H-7 [D-2]), 4.36 (J = 5.3, 8.8 Hz, 1H, dd, H-6 [D-1]), 4.24 (J = 1.4, 10.8 Hz, 1H, dd, H-6 [D-2]), 3.92 – 3.87 (2H + 2H, m, H-1 [D-1] and H-1 [D-2]), 3.83 (3H + 3H, s, H-14 [D-1] and H-14 [D-2]), 3.81 (3H, s, H-13 [D-1]), 3.79 (3H, s, H-13 [D-2]), 3.65 – 3.01 (6H + 6H, m, H-2 [D-1], H-2 [D-2], H-4 [D-1], H-4 [D-2], OH [D-1], OH [D-2], OH [D-1], OH [D-2], OH [D-1] and OH [D-2]), 2.60 – 1.70 (3H + 3H, m, H-3 [D-1], H-3 [D-2], H-5 [D-1] and H-5 [D-2]); $^{13}\text{C-NMR}$ (CDCl_3 , 75 MHz): δ 157.1, 155.5, 148.9, 148.7, 147.5, 142.1, 141.6, 134.9, 134.8, 120.3, 119.9, 111.2, 111.1, 110.1, 110.0, 107.0, 105.2, 66.0, 65.0, 64.0, 63.9, 63.6, 62.6, 55.8, 55.8, 46.8, 39.7, 38.7, 38.6; *IR:* $\bar{\nu}$ 3330 (O-H), 2934, 2835, 1590, 1511, 1463, 1420, 1255, 1233, 1139, 1022, 914, 861, 808, 728, 646, 598; R_f (ethyl acetate) 0.19; *Mass Spectrometry:* TOF ES^+ : MNa^+ : Expected: m/z 359.1471, Observed: m/z 359.1455, Difference = -4.46 ppm

Synthesis of 3-(4-bromophenyl)-1-(furan-2-yl)-4-(hydroxymethyl)pentane-1,5-diol
(287f)

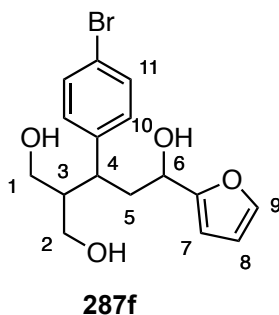

Experimental procedure followed matched that described for **287b** using:

Lithium aluminium hydride (107 mg, 2.82 mmol, 10.1 eqv.), dimethyl-2-(1-(4-bromophenyl)-3-(furan-2-yl)-3-oxopropyl)malonate (**271f**) (114 mg, 0.279 mmol, 1.00 eqv.) and THF (25.0 mL). The product was a cream coloured solid.

Diastereomeric Ratio: **1:1.3**; *Yield:* 35% (34.9 mg, 0.0982 mmol); ¹H-NMR (CD₃OD, 400 MHz): δ 7.47 – 7.42 (3H + [1.3] 2H, m, **H-9 [D-1]**, **H-10 [D-1]** and **H-10 [D-2]**), 7.36 ([1.3] 1H, s, **H-9 [D-2]**), 7.19 (J = 8.3 Hz, [1.3] 2H, d, **H-11 [D-2]**), 7.06 (J = 8.3 Hz, 2H, d, **H-11 [D-1]**), 6.35 (1H, m, **H-8 [D-1]**), 6.28 ([1.3] 1H, m, **H-8 [D-2]**), 6.20 (J = 3.0 Hz, 1H, d, **H-7 [D-1]**), 6.14 (J = 3.0 Hz, [1.3] 1H, d, **H-7 [D-2]**), 4.20 (J = 4.7, 10.1 Hz, 1H, dd, **H-6 [D-1]**), 4.13 (J = 2.5, 10.5 Hz, [1.3] 1H, **H-6 [D-2]**), 3.76 (J = 4.9 Hz, [1.3] 2H, d, **H-1 [D-2]**), 3.70 (J = 5.1 Hz, 2H, dd, **H-1 [D-1]**), 3.50 – 3.38 (1H + [1.3] 1H, d, **H-2 [D-1]** and **H-2 [D-2]**), 3.35 – 3.23 ([1.3] 1H, m, **H-2 [D-2]**), 3.23 – 3.10 (1H + [1.3] 1H, m, **H-2 [D-1]** and **H-4 [D-2]**), 2.60 (1H, m, **H-5 [D-1]**), 2.50 (J = 3.9, 10.3, 13.0 Hz, 1H, ddd, **H-4 [D-1]**), 2.33 (J = 3.4, 10.7, 13.8 Hz, [1.3] 1H, ddd, **H-5 [D-2]**), 2.18 (J = 4.5, 13.0, 13.1 Hz, 1H, ddd, **H-5 [D-1]**), 2.07 ([1.3] 1H, m, **H-5 [D-2]**), 1.90 – 1.79 (1H + [1.3] 1H, m, **H-3 [D-1]** and **H-3 [D-2]**); ¹³C-NMR (CD₃OD, 100 MHz): δ 159.0, 157.2, 143.4, 143.4, 143.3, 142.8,

132.5, 132.5, 131.8, 131.6, 121.1, 121.0, 111.1, 111.0, 108.1, 106.2, 66.7, 65.9, 62.2, 61.9, 61.7, 61.6, 49.4, 41.3, 40.9, 39.8, 39.7; *IR*: $\bar{\nu}$ 3355 (O-H), 2933, 2895, 1485, 1449, 1425, 1407, 1331, 1147, 1046, 1007, 964, 924, 875, 808, 736, 597, 541; *Melting Point*: 129 – 130 °C; *R_f* (ethyl acetate) 0.36; *Mass Spectrometry*: (MNa⁺) Expected: *m/z* 377.0369, Found: *m/z* 377.0364, Error: 1.3 ppm

Synthesis of 3-(4-bromophenyl)-4-(hydroxymethyl)-1-(5-methylfuran-2-yl)pentane-1,5-diol (287h)

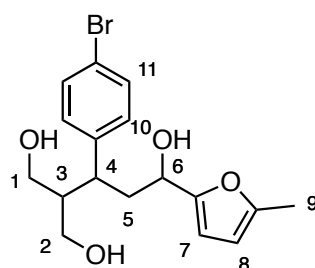

287h

Experimental procedure followed matched that described for **287b** using:

Lithium aluminium hydride (89.3 mg, 2.35 mmol, 13.8 eqv.), dimethyl-2-(1-(4-bromophenyl)-3-(5-methylfuran-2-yl)-3-oxopropyl)malonate (**271h**) (72.0 mg, 0.170 mmol, 1.00 eqv.) and THF (25.0 mL). The product was a pale yellow oil.

Diastereomeric Ratio: 1.7:1; *Yield*: 28% (17.7 mg, 0.479 mmol); ¹H-NMR (CDCl₃, 300 MHz): δ 7.46 – 7.38 ([1.7] 2H + 2H, m, H-10 [D-1] and H-10 [D-2]), 7.12 – 6.94 ([1.7] 2H + 2H, m, H-11 [D-1] and H-11 [D-2]), 6.04 (J = 2.4 Hz, [1.7] 1H, d, H-7 [D-1]), 5.96 (J = 2.4 Hz, 1H, d, H-7 [D-2]), 5.88 (J = 2.4 Hz, [1.7] 1H, d, H-8 [D-1]), 5.83 (J = 2.4 Hz, 1H, d, H-8 [D-2]), 4.30 (J = 4.5, 8.1 Hz, [1.7] 1H, dd, H-6 [D-1]), 4.16 – 4.10 (1H, m, H-6 [D-2]), 4.10 – 1.60 ([1.7] 11H + 11H, m, H-1 [D-1], H-1 [D-2], H-2 [D-1], H-2 [D-2], H-3 [D-1], H-3 [D-2], H-4 [D-1], H-4 [D-2], H-5 [D-1], H-5

[D-2], OH [D-1], OH [D-2], OH [D-1], OH [D-2], OH [D-1] and OH [D-2]), 2.23 ([1.7] 3H, s, H-9 [D-1]), 2.20 (3H, s, H-9 [D-2]); $^{13}\text{C-NMR}$ (CDCl_3 , 75 MHz): δ 154.9, 153.4, 152.1, 151.6, 141.8, 131.8, 131.6, 130.2, 129.9, 120.3, 120.3, 108.2, 106.4, 106.1, 106.0, 66.1, 65.1, 64.7, 56.0, 56.0, 53.5, 46.5, 39.3, 38.5, 38.5, 38.4, 13.6, 13.5; *IR*: $\bar{\nu}$ 3336 (O-H), 2920, 1486, 1408, 1218, 1008, 962, 908, 784, 727, 554; *R_f* (ethyl acetate) 0.30; *Mass Spectrometry*: TOF ES⁺: MNa⁺: Expected: *m/z* 391.0521, Observed: *m/z* 391.0507, Difference = -3.58 ppm

Synthesis of 4-(hydroxymethyl)-1-(5-methylfuran-2-yl)-3-phenylpentane-1,5-diol
(**287i**)

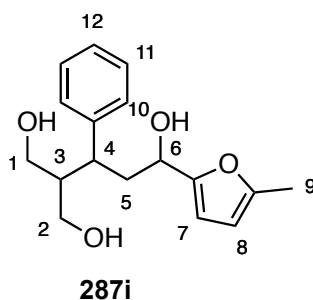

Experimental procedure followed matched that described for **287b** using:

Lithium aluminium hydride (112 mg, 2.95 mmol, 9.97 eqv.), dimethyl-2-(3-(5-methylfuran-2-yl)-3-oxo-1-phenylpropyl)malonate (**271i**) (102 mg, 0.296 mmol, 1.00 eqv.) and THF (15.0 mL). The product was a pale yellow oil.

Diastereomeric Ratio: 2:1; *Yield*: 35% (30.0 mg, 0.103 mmol); $^1\text{H-NMR}$ (CDCl_3 , 300 MHz): δ 7.32 – 7.06 ([2] 5H + 5H, m, H-10 [D-1], H-10 [D-2], H-11 [D-1], H-11 [D-2], H-12 [D-1] and H-12 [D-2]), 6.04 (J = 3.1 Hz, [2] 1H, d, H-7 [D-1]), 5.95 (J = 3.1 Hz, 1H, d, H-7 [D-2]), 5.87 (J = 0.8, 3.1 Hz, [2] 1H, dd, H-8 [D-1]), 5.82 (J = 0.9, 3.1 Hz, 1H, dd, H-8 [D-2]), 4.30 (J = 5.4, 9.0 Hz, [2] 1H, dd, H-6 [D-1]), 4.16 (J

= 1.9, 10.8 Hz, 1H, dd, H-6 [D-2]), 3.93 (J = 3.3, 10.9 Hz, [2] 2H, dd, H-1 [D-1]), 3.82 (J = 6.1, 11.0 Hz, 2H, dd, H-1 [D-2]), 3.53 (J = 3.2, 10.7 Hz, [2] 2H, dd, H-2 [D-1]), 3.41 (J = 5.1, 11.5 Hz, 2H, dd, H-2 [D-2]), 3.15 (1H, m, H-4 [D-2]), 2.58 (J = 4.1, 10.2, 10.6 Hz, [2] 1H, ddd, H-4 [D-1]), 2.43 (J = 4.1, 9.0, 13.1 Hz, [2] 1H, ddd, H-5 [D-1]), 2.33 (1H, m, H-5 [D-2]), 2.24 (J = 0.8 Hz, [2] 3H, d, H-9 [D-1]), 2.20 (J = 0.9 Hz, 3H, d, H-9 [D-2]), 2.15 (J = 5.4, 10.6, 13.3 Hz, [2] 1H, ddd, H-5 [D-1]), 2.04 – 1.75 ([2] 1H + 2H, m, H-5 [D-2], H-3 [D-1] and H-3 [D-2]); $^{13}\text{C-NMR}$ (CDCl_3 , 75 MHz): δ 155.2, 153.5, 151.9, 151.4, 142.5, 128.6, 128.5, 128.3, 128.1, 126.6, 126.5, 108.0, 106.1, 106.0, 105.9, 66.1, 65.0, 64.1, 63.9, 46.6, 46.6, 40.1, 39.0, 38.5, 13.6, 13.5; *IR*: $\bar{\nu}$ 3307 (O-H), 2921, 1452, 1219, 1019, 961, 909, 783, 729, 701, 587; *R_f* (ethyl acetate) 0.36; *Mass Spectrometry*: TOF ES⁺: MNa⁺: Expected: *m/z* 313.1416, Observed: *m/z* 313.1411, Difference = -1.60 ppm

Synthesis of 4-(hydroxymethyl)-1-(5-methylfuran-2-yl)-3-*p*-tolylpentane-1,5-diol (287j)

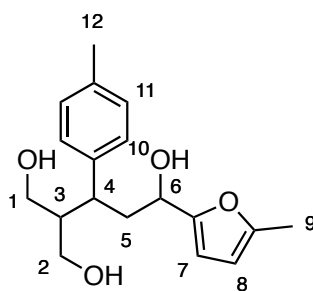

287j

Experimental procedure followed matched that described for **287b** using:

Lithium aluminium hydride (0.368 g, 9.70 mmol, 9.07 eqv.), dimethyl-2-(3-(5-methylfuran-2-yl)-3-oxo-1-*p*-tolylpropyl)malonate (**271j**) (0.359 g, 1.07 mmol, 1.00 eqv.) and THF (17.0 mL). The product was a yellow oil.

Diastereomeric Ratio: 1.7:1; *Yield:* 31% (94.9 mg, 0.312 mmol); $^1\text{H-NMR}$ (CDCl_3 , 300 MHz): δ 7.10 – 6.93 ([1.7] 4H + 4H, m, H-10 [D-1], H-10 [D-2], H-11 [D-1] and H-11 [D-2]), 6.02 (J = 3.0 Hz, [1.7] 1H, d, H-7 [D-1]), 5.94 (J = 3.0 Hz, 1H, d, H-7 [D-2]), 5.86 (J = 3.0 Hz, [1.7] 1H, d, H-8 [D-1]), 5.81 (J = 3.0 Hz, 1H, d, H-8 [D-2]), 4.29 (J = 5.4, 9.0 Hz, [1.7] 1H, dd, H-6 [D-1]), 4.16 (J = 1.6, 10.7 Hz, 1H, dd, H-6 [D-2]), 3.95 – 3.73 ([1.7] 2H + 2H, m, H-1 [D-1] and H-1 [D-2]), 3.55 – 3.25 ([1.7] 2H + 2H, m, H-2 [D-1] and H-2 [D-2]), 3.09 (1H, m, H-4 [D-2]), 2.52 (J = 4.1, 10.4, 10.4 Hz, [1.7] 1H, ddd, H-4 [D-1]), 2.45 – 2.05 ([1.7] 2H + 1H, m, H-5 [D-1] and H-5 [D-2]), 2.31 ([1.7] 3H + 3H, s, H-12 [D-1] and H-12 [D-2]), 2.23 ([1.7] 3H, s, H-9 [D-1]), 2.20 (3H, s, H-9 [D-2]), 2.02 – 1.75 ([1.7] 1H + 2H, m, H-5 [D-2], H-3 [D-1] and H-3 [D-2]); $^{13}\text{C-NMR}$ (CDCl_3 , 75 MHz): δ 155.3, 153.6, 151.8, 151.3, 139.3, 139.3, 136.0, 135.9, 129.2, 129.2, 128.1, 127.9, 107.9, 106.0, 106.0, 105.8, 66.0, 64.9, 64.0, 63.8, 62.7, 50.5, 46.7, 46.7, 39.8, 38.7, 38.6, 38.5, 21.0, 13.5, 13.4; *IR:* $\bar{\nu}$ 3312 (O-H), 2920, 1512, 1435, 1219, 1019, 962, 909, 783, 727, 570; *R_f* (ethyl acetate) 0.42; *Mass Spectrometry:* TOF ES⁺: MNa⁺: Expected: *m/z* 327.1572, Observed: *m/z* 327.1561, Difference = -3.36 ppm

Synthesis of 3-(4-chlorophenyl)-4-(hydroxymethyl)-1-(5-methylfuran-2-yl)pentane-1,5-diol (287k)

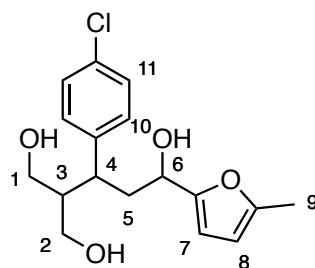

287k

Experimental procedure followed matched that described for **287b** using:

Lithium aluminium hydride (91.4 mg, 2.41 mmol, 11.4 eqv.), dimethyl-2-(1-(4-chlorophenyl)-3-(5-methylfuran-2-yl)-3-oxopropyl)malonate (**271k**) (80.3 mg, 0.212 mmol, 1.00 eqv.) and THF (14.0 mL). The product was a pale yellow oil.

Diastereomeric Ratio: 1.7:1; *Yield:* 37% (25.4 mg, 0.0782 mmol); $^1\text{H-NMR}$ (CDCl_3 , 300 MHz): δ 7.29 – 6.98 ([1.7] 4H + 4H, m, H-10 [D-1], H-10 [D-2], H-11 [D-1] and H-11 [D-2]), 6.03 (J = 3.0 Hz, [1.7] 1H, d, H-7 [D-1]), 5.95 (J = 3.1 Hz, 1H, d, H-7 [D-2]), 5.87 (J = 0.8, 3.0 Hz, [1.7] 1H, dd, H-8 [D-1]), 5.82 (J = 0.8, 3.1 Hz, 1H, dd, H-8 [D-2]), 4.29 (J = 5.2, 9.0 Hz, [1.7] 1H, dd, H-6 [D-1]), 4.12 (J = 1.9, 10.9 Hz, 1H, dd, H-6 [D-2]), 3.97 – 3.78 ([1.7] 2H + 2H, m, H-1 [D-1] and H-1 [D-2]), 3.60 – 2.80 ([1.7] 5H + 6H, m, H-2 [D-1], H-2 [D-2], OH [D-1], OH [D-2], OH [D-1], OH [D-2], OH [D-1], OH [D-2] and H-4 [D-2]), 2.61 (J = 4.0, 9.9, 10.2 Hz, [1.7] 1H, ddd, H-4 [D-1]), 2.46 – 2.27 ([1.7] 1H + 1H, m, H-5 [D-1] and H-5 [D-2]), 2.23 (J = 0.8 Hz, [1.7] 3H, d, H-9 [D-1]), 2.20 (J = 0.8 Hz, 3H, d, H-9 [D-2]), 2.11, (J = 5.2, 10.2, 13.5 Hz, [1.7] 1H, ddd, H-5 [D-1]), 1.93 – 1.70 ([1.7] 1H + 2H, m, H-5 [D-2], H-3 [D-1] and H-3 [D-2]); $^{13}\text{C-NMR}$ (CDCl_3 , 75 MHz): δ 154.9, 153.3, 152.0, 151.5, 141.2, 141.1, 132.1, 129.7, 129.4, 128.7, 128.6, 108.0, 106.3, 106.0, 105.9, 66.0, 64.9, 63.9, 63.9, 63.5, 62.7, 46.6, 46.5, 39.3, 38.4, 38.4, 13.5, 13.5; *IR:* $\bar{\nu}$ 3316 (O-H), 2921, 1489, 1411, 1219, 1089, 1012, 962, 820, 784, 723, 553; *R_f* (ethyl acetate) 0.41; *Mass Spectrometry:* TOF ES⁺: MNa⁺: Expected: *m/z* 347.1026, Observed: *m/z* 347.1019, Difference = -2.02 ppm

Synthesis of ((3*S*,4*S*,6*S*)-6-(furan-2-yl)-4-phenyltetrahydro-2*H*-pyran-3-yl)methanol
(288a)

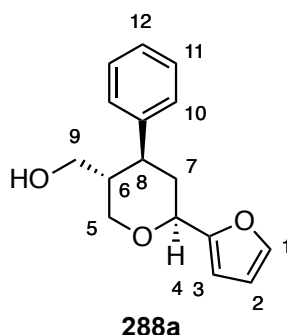

Lithium aluminium hydride (0.368 g, 9.70 mmol, 10.6 eqv.) was dissolved in tetrahydrofuran (15.0 mL). This was then cooled to -15°C and dimethyl-2-(3-(furan-2-yl)-3-oxo-1-phenylpropyl)malonate (**271a**) (0.303 g, 0.917 mmol, 1.00 eqv.) in THF (10.0 mL) was added. The reaction was stirred at room temperature for 30 minutes. After this, the reaction was quenched by the addition of diethyl ether (20.0 mL), followed by a 4:1 mixture of diethyl ether and acetone (20.0 mL) at -15°C . The reaction mixture was then diluted with ethyl acetate (60.0 mL), water (150 mL) and 2M aqueous sodium hydroxide solution (200 mL). Extraction was completed using ethyl acetate (3 \times 60.0 mL). The combined organic phases were washed with water (2 \times 100 mL) and brine (100 mL). This was then dried over magnesium sulfate and concentrated under reduced pressure. The crude material (50.0 mg, 0.181 mmol) was then dissolved in acetonitrile (6.00 mL) and Quadrapure™ polymer-supported sulfonic acid (20.3 mg) was added. This was stirred for 24 hours before being filtered, concentrated under reduced pressure and fully characterised. The product was a brown oil.

Yield: 23% over 2 steps (46.4 mg, 0.180 mmol); *Diastereomeric Ratio*: 12:1; $^1\text{H-NMR}$ (CDCl_3 , 300 MHz): δ 7.40 ($J = 1.8$ Hz, 1H, d, H-1), 7.35 – 7.23 (5H, m, H-10,

H-11 and H-12), 6.35 (J = 1.8, 3.3 Hz, 1H, dd, H-2), 6.30 (J = 3.3 Hz, 1H, d, H-3), 4.56 (J = 3.6, 10.1 Hz, 1H, dd, H-4), 4.38 (J = 4.4, 11.4 Hz, 1H, dd, H-5), 3.64 (J = 11.3, 11.4, Hz, 1H, dd, H-5), 3.47 (J = 3.3, 11.1 Hz, 1H, dd, H-9), 3.31 (J = 6.9, 11.1 Hz, 1H, dd, H-9), 2.78 (J = 5.3, 11.1, 11.2 Hz, 1H, ddd, H-8), 2.21 – 2.07 (3H, m, H-6 and H-7); $^{13}\text{C-NMR}$ (CDCl_3 , 75 MHz): δ 154.3, 143.1, 142.2, 128.8, 127.4, 126.9, 110.1, 106.5, 73.1, 71.2, 62.2, 44.0, 43.4, 37.6; *IR*: $\bar{\nu}$ 3373 (O-H), 2918, 2862, 1494, 1452, 1352, 1336, 1228, 1066, 1040, 1009, 923, 911, 883, 759, 734, 699, 598, 544; R_f (diethyl ether) 0.90; *Mass Spectrometry*: TOF ES^+ : MNa^+ : Expected: m/z 281.1154, Observed: m/z 281.1143, Difference = -3.91 ppm

Synthesis of ((3*S*,4*S*,6*S*)-4-(4-chlorophenyl)-6-(furan-2-yl)tetrahydro-2*H*-pyran-3-yl)methanol (**288b**)

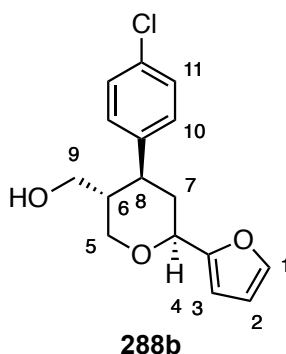

3-(4-chlorophenyl)-1-(furan-2-yl)-4-(hydroxymethyl)pentane-1,5-diol (**287b**) (18.1 mg, 0.0582 mmol) was then dissolved in acetonitrile (6.00 mL) and Quadrapure™ polymer-supported sulfonic acid (11.3 mg) was added. This was stirred for 24 hours before being filtered, concentrated under reduced pressure and fully characterised. The product was a colourless oil.

Yield: 89% (15.1 mg, 0.0516 mmol); *Diastereomeric Ratio:* 17:1; $^1\text{H-NMR}$ (CDCl_3 , 300 MHz): δ 7.39 (J = 1.8 Hz, 1H, d, H-1), 7.32 – 7.29 (2H, m, H-11), 7.22 – 7.17 (2H, m, H-10), 6.33 (J = 1.8, 3.3 Hz, 1H, dd, H-2), 6.28 (J = 3.3 Hz, 1H, d, H-3), 4.53 (J = 4.2, 9.5 Hz, 1H, dd, H-4), 4.35 (J = 4.4, 11.5 Hz, 1H, dd, H-5), 3.64 (J = 11.3, 11.5 Hz, 1H, dd, H-5), 3.47 (J = 3.2, 11.0 Hz, 1H, dd, H-9), 3.31 (J = 6.7, 11.0 Hz, 1H, dd, H-9), 2.79 (J = 5.8, 8.2, 11.1 Hz, 1H, ddd, H-8), 2.14 – 2.03 (3H, m, H-6 and H-7); $^{13}\text{C-NMR}$ (CDCl_3 , 75 MHz): δ 154.0, 142.3, 141.6, 132.4, 128.9, 128.8, 110.1, 106.6, 73.0, 71.1, 61.8, 43.2, 43.1, 37.5; *IR:* $\bar{\nu}$ 3401 (O-H), 2920, 2855, 1723, 1491, 1338, 1147, 1073, 1044, 1012, 908, 826, 731, 632, 599, 530, 494; *R_f* (diethyl ether) 0.90; *Mass Spectrometry:* TOF ES⁺: MNa⁺: Expected: *m/z* 315.0764, Observed: *m/z* 315.0777, Difference = 4.13 ppm

Synthesis of ((3S,4S,6S)-6-(furan-2-yl)-4-(4-methoxyphenyl)tetrahydro-2H-pyran-3-yl)methanol (288c)

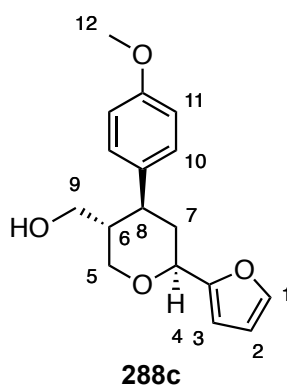

Experimental procedure followed matched that described for **288b** using:

1-(furan-2-yl)-4-(hydroxymethyl)-3-(4-methoxyphenyl)pentane-1,5-diol (**287c**) (45.0 mg, 0.147 mmol), Quadrapure™ polymer-supported sulfonic acid (19.4 mg) and acetonitrile (3.50 mL). The product was a yellow oil.

Yield: 87% (36.9 mg, 0.128 mmol); *Diastereomeric Ratio:* 18:1; $^1\text{H-NMR}$ (CDCl_3 , 300 MHz): δ 7.37 (J = 1.4 Hz, 1H, d, H-1), 7.17 (J = 8.6 Hz, 2H, d, H-10), 6.87 (J = 8.6 Hz, 2H, d, H-11), 6.32 (J = 1.4, 3.2 Hz, 1H, dd, H-2), 6.27 (J = 3.2 Hz, 1H, d, H-3), 4.52 (J = 4.0, 9.7 Hz, 1H, dd, H-4), 4.33 (J = 4.3, 11.4 Hz, 1H, dd, H-5), 3.79 (3H, s, H-12), 3.60 (J = 11.3, 11.4 Hz, 1H, dd, H-5), 3.46 (J = 3.3, 11.0 Hz, 1H, dd, H-9), 3.29 (J = 6.7, 11.0 Hz, 1H, dd, H-9), 2.70 (J = 6.0, 11.0, 11.1 Hz, 1H, dd, H-8), 2.09 – 2.00 (3H, m, H-6 and H-7); $^{13}\text{C-NMR}$ (CDCl_3 , 75 MHz): δ 158.4, 154.3, 142.2, 135.2, 128.3, 114.1, 110.1, 106.4, 73.1, 71.2, 62.3, 55.3, 43.6, 43.1, 37.8; *IR:* $\bar{\nu}$ 3390 (O-H), 2937, 2916, 2835, 1610, 1511, 1462, 1248, 1178, 1073, 1036, 1011, 830, 732, 632, 530, 495; *R_f* (diethyl ether) 0.76; *Mass Spectrometry:* TOF ES⁺: MH⁺: Expected: *m/z* 289.1440, Observed: *m/z* 289.1433, Difference = -2.42 ppm

Synthesis of ((3S,4S,6S)-6-(furan-2-yl)-4-p-tolyltetrahydro-2H-pyran-3-yl)methanol (288d)

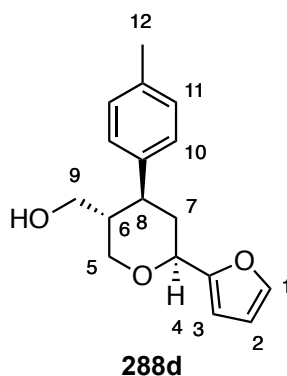

Experimental procedure followed matched that described for **288b** using:

1-(furan-2-yl)-4-(hydroxymethyl)-3-p-tolylpentane-1,5-diol (**287d**) (104 mg, 0.358 mmol), Quadrapure™ polymer-supported sulfonic acid (25.7 mg) and acetonitrile (5.00 mL). The product was a yellow oil.

Yield: 95% (92.5 mg, 0.340 mmol); *Diastereomeric Ratio:* 13:1; $^1\text{H-NMR}$ (CDCl_3 , 300 MHz): δ 7.38 (J = 1.8 Hz, 1H, d, H-1), 7.16 – 7.12 (4H, m, H-10 and H-11), 6.33 (J = 1.8, 3.3 Hz, 1H, dd, H-2), 6.27 (J = 3.3 Hz, 1H, d, H-3), 4.53 (J = 3.7, 10.1 Hz, 1H, dd, H-4), 4.35 (J = 4.4, 11.4 Hz, 1H, dd, H-5), 3.62 (J = 11.3, 11.4 Hz, 1H, dd, H-6), 3.47 (J = 3.4, 11.0 Hz, 1H, dd, H-9), 3.31 (J = 6.8, 11.0 Hz, 1H, dd, H-9), 2.73 (J = 6.3, 11.2, 11.3 Hz, 1H, ddd, H-8), 2.34 (3H, s, H-12), 2.17 – 1.98 (3H, m, H-6 and H-7); $^{13}\text{C-NMR}$ (CDCl_3 75 MHz): δ 154.3, 142.2, 140.0, 136.4, 129.5, 127.3, 110.1, 106.4, 73.1, 71.2, 62.3, 43.6, 43.4, 37.7, 21.0; *IR:* $\bar{\nu}$ 3401 (O-H), 2918, 2858, 1723, 1514, 1457, 1280, 1227, 1147, 1073, 1041, 1009, 925, 816, 737, 586, 550, 508; *R_f* (diethyl ether) 0.71; *Mass Spectrometry:* TOF ES⁺: MNa⁺: Expected: *m/z* 295.1310, Observed: *m/z* 295.1320, Difference = 3.39 ppm

Synthesis of ((3S,4S,6S)-4-(3,4-dimethoxyphenyl)-6-(furan-2-yl)tetrahydro-2H-pyran-3-yl)methanol (**288e**)

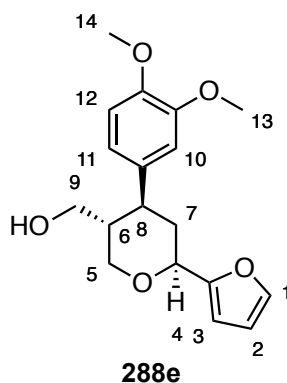

Experimental procedure followed matched that described for **288b** using:

3-(3,4-dimethoxyphenyl)-1-(furan-2-yl)-4-(hydroxymethyl)pentane-1,5-diol (**287e**) (30.0 mg, 0.0892 mmol), Quadrapure™ polymer-supported sulfonic acid (19.4 mg) and acetonitrile (2.50 mL). The product was a yellow oil.

Yield: 89% (25.2 mg, 0.0792 mmol); *Diastereomeric Ratio:* 19:1; $^1\text{H-NMR}$ (CDCl_3 , 300 MHz): δ 7.38 (J = 0.7, 1.8 Hz, 1H, dd, H-1), 6.82 – 6.78 (3H, m, H-10, H-11 and H-12), 6.33 (J = 1.8, 2.9 Hz, 1H, dd, H-2), 6.28 (J = 0.7, 2.9 Hz, 1H, dd, H-3), 4.53 (J = 4.6, 9.1 Hz, 1H, dd, H-4), 4.34 (J = 4.4, 11.4 Hz, 1H, dd, H-5), 3.88 (3H, s, H-14), 3.86 (3H, s, H-13), 3.62 (J = 11.3, 11.4 Hz, 1H, dd, H-5), 3.49 (J = 3.4, 11.0 Hz, 1H, dd, H-9), 3.33 (J = 6.7, 11.0 Hz, 1H, dd, H-9), 2.72 (J = 6.3, 8.3, 10.8 Hz, 1H, ddd, H-8), 2.15 – 2.04 (3H, m, H-6 and H-7); $^{13}\text{C-NMR}$ (CDCl_3 , 75 MHz): δ 154.2, 149.1, 147.8, 142.3, 135.7, 119.4, 111.3, 110.2, 110.1, 106.5, 73.2, 71.2, 62.3, 55.9, 55.9, 43.7, 43.6, 37.8; *IR:* $\bar{\nu}$ 3345 (O-H), 2947, 2923, 2873, 2836, 1516, 1463, 1452, 1340, 1261, 1241, 1157, 1121, 1077, 1026, 1012, 952, 921, 881, 809, 767, 738, 701, 599, 535; *R_f* (diethyl ether) 0.36; *Mass Spectrometry:* TOF ES⁺: MH⁺: Expected: *m/z* 319.1545, Observed: *m/z* 319.1530, Difference = -4.70 ppm

Synthesis of ((3S,4S,6S)-4-(4-bromophenyl)-6-(furan-2-yl)tetrahydro-2H-pyran-3-yl)methanol (288f)

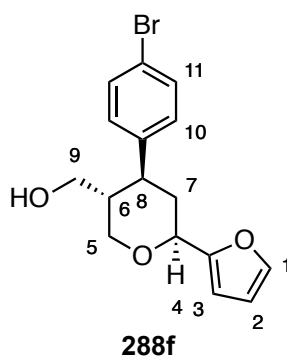

Experimental procedure followed matched that described for **288b** using:

3-(4-bromophenyl)-1-(furan-2-yl)-4-(hydroxymethyl)pentane-1,5-diol (**287f**) (28.0 mg, 0.0788 mmol), Quadrapure™ polymer-supported sulfonic acid (20.7 mg) and acetonitrile (3.50 mL). The product was a pale yellow oil.

Yield: 86% (22.8 mg, 0.0676 mmol); *Diastereomeric Ratio:* 10:1; $^1\text{H-NMR}$ (CDCl_3 , 300 MHz): δ 7.46 (J = 8.4 Hz, 2H, d, H-10), 7.38 (J = 1.7 Hz, 1H, d, H-1), 7.14 (J = 8.4 Hz, 2H, d, H-11), 6.33 (J = 1.7, 3.2 Hz, 1H, dd, H-2), 6.28 (J = 3.2 Hz, 1H, d, H-3), 4.53 (J = 5.6, 8.2 Hz, 1H, dd, H-4), 4.34 (J = 4.5, 11.5 Hz, 1H, dd, H-5), 3.64 (J = 11.3, 11.5 Hz, 1H, dd, H-5), 3.46 (J = 3.2, 11.0 Hz, 1H, dd, H-9), 3.30 (J = 6.7, 11.0 Hz, 1H, dd, H-9), 2.78 (J = 5.9, 8.3, 10.8 Hz, 1H, ddd, H-8), 2.13 – 2.03 (3H, m, H-6 and H-7); $^{13}\text{C-NMR}$ (CDCl_3 , 75 MHz): δ 154.0, 142.3, 142.1, 131.8, 129.2, 120.5, 110.1, 106.6, 73.0, 71.1, 61.8, 43.2, 43.1, 37.4; *IR:* $\bar{\nu}$ 3391 (O-H), 2919, 1488, 1148, 1072, 1044, 1009, 908, 822, 731, 648, 599, 536, 495; *R_f* (diethyl ether) 0.79; *Mass Spectrometry:* TOF ES^+ : MNa^+ : Expected: m/z 359.0259, Observed: m/z 359.0243, Difference = -4.46 ppm

Synthesis of ((3S,4S,6S)-4-(4-bromophenyl)-6-(5-methylfuran-2-yl)tetrahydro-2H-pyran-3-yl)methanol (288h)

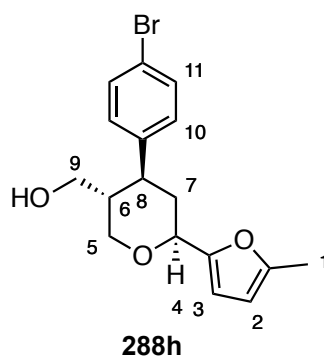

Experimental procedure followed matched that described for **288b** using: 3-(4-bromophenyl)-4-(hydroxymethyl)-1-(5-methylfuran-2-yl)pentane-1,5-diol (**287h**) (13.3 mg, 0.0360 mmol), Quadrapure™ polymer-supported sulfonic acid (18.2 mg) and acetonitrile (2.50 mL). The product was a yellow oil.

Yield: 63% (8.0 mg, 0.0228 mmol); *Diastereomeric Ratio:* 12:1; $^1\text{H-NMR}$ (CDCl_3 , 300 MHz): δ 7.47 – 7.44 (2H, m, H-10), 7.17 – 7.13 (2H, m, H-11), 6.15 (J = 3.1 Hz, 1H, d, H-3), 5.90 (J = 0.9, 3.1 Hz, 1H, dd, H-2), 4.47 (J = 3.5, 10.2 Hz, 1H, dd, H-4), 4.35 (J = 4.4, 11.5 Hz, 1H, dd, H-5), 3.63 (J = 11.3, 11.5 Hz, 1H, dd, H-5), 3.47 (J = 3.2, 10.9 Hz, 1H, dd, H-9), 3.31 (J = 6.7, 10.9 Hz, 1H, dd, H-9), 2.81 – 2.71 (1H, m, H-8), 2.28 (J = 0.9 Hz, 3H, d, H-1), 2.11 – 2.01 (3H, m, H-6 and H-7); $^{13}\text{C-NMR}$ (CDCl_3 , 75 MHz): δ 152.2, 152.1, 142.2, 131.8, 129.2, 120.4, 107.6, 106.0, 73.0, 71.0, 61.9, 43.3, 43.2, 37.3, 13.6; *IR:* $\bar{\nu}$ 3402 (O-H), 2919, 2360, 1712, 1488, 1377, 1222, 1132, 1071, 1051, 1009, 909, 849, 822, 785, 730, 633, 540, 493; *R_f* (diethyl ether) 0.78; *Mass Spectrometry:* TOF ES⁺: MNa⁺: Expected: *m/z* 391.0521, Observed: *m/z* 391.0507, Difference = –3.58 ppm

Synthesis of ((3S, 4S, 6S)-6-(5-methylfuran-2-yl)-4-phenyltetrahydro-2H-pyran-3-yl)methanol (288i)

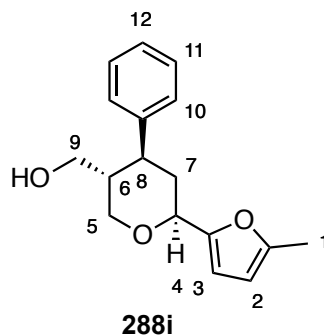

Experimental procedure followed matched that described for **288b** using:

4-(hydroxymethyl)-1-(5-methylfuran-2-yl)-3-phenylpentane-1,5-diol (**287i**) (22.5 mg, 0.0775 mmol), Quadrapure™ polymer-supported sulfonic acid (11.6 mg) and acetonitrile (3.00 mL). The product was a colourless oil.

Yield: 84% (17.7 mg, 0.0650 mmol); Diastereomeric Ratio: 12:1; $^1\text{H-NMR}$ (CDCl_3 , 300 MHz): δ 7.33 – 7.25 (5H, m, H-10, H-11 and H-12), 6.15 (J = 3.1 Hz, 1H, d, H-3), 5.90 (J = 0.8, 3.1 Hz, 1H, dd, H-2), 4.48 (J = 2.9, 10.8 Hz, 1H, dd, H-4), 4.36 (J = 4.3, 11.4 Hz, 1H, dd, H-5), 3.63 (J = 11.3, 11.4, 1H, dd, H-5), 3.47 (J = 6.8, 11.0 Hz, 1H, dd, H-9), 3.31 (J = 6.8, 11.0 Hz, 1H, dd, H-9), 2.76 (J = 4.8, 11.4, 11.5 Hz, 1H, ddd, H-8), 2.28 (J = 0.8 Hz, 3H, d, H-1), 2.15 – 2.03 (3H, m, H-6 and H-7); $^{13}\text{C-NMR}$ (CDCl_3 , 75 MHz): δ 152.4, 152.1, 143.2, 128.8, 127.4, 126.8, 107.5, 106.0, 73.0, 71.2, 62.3, 44.1, 43.3, 37.5, 13.6; *IR*: $\bar{\nu}$ 3402 (O-H), 2942, 2918, 2853, 1565, 1452, 1378, 1335, 1221, 1129, 1048, 1018, 949, 782, 760, 700, 554, 493; R_f (diethyl ether) 0.84; *Mass Spectrometry*: TOF ES^+ : MNa^+ : Expected: m/z 295.1310, Observed: m/z 295.1309, Difference = -0.34 ppm

Synthesis of ((3*S*,4*S*,6*S*)-6-(5-methylfuran-2-yl)-4-*p*-tolyltetrahydr-2*H*-pyran-3-yl)methanol (**288j**)

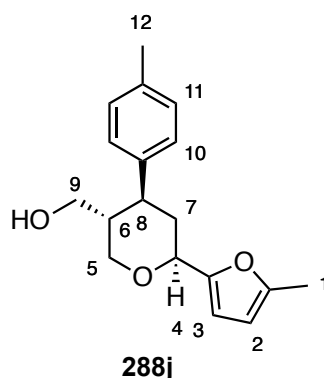

Experimental procedure followed matched that described for **288b** using: 4-(hydroxymethyl)-1-(5-methylfuran-2-yl)-3-*p*-tolylpentane-1,5-diol (**287j**) (65.0 mg, 0.214 mmol), Quadrapure™ polymer-supported sulfonic acid (10.4 mg) and acetonitrile (4.00 mL). The product was a deep yellow oil.

Yield: 75% (46.0 mg, 0.161 mmol); *Diastereomeric Ratio:* 13:1; $^1\text{H-NMR}$ (CDCl_3 , 300 MHz): δ 7.16 – 7.13 (4H, m, H-10 and H-11), 6.15 (J = 3.1 Hz, 1H, d, H-3), 5.90 (J = 0.8, 3.1 Hz, 1H, dd, H-2), 4.47 (J = 2.9, 10.7 Hz, 1H, dd, H-4), 4.34 (J = 4.4, 11.4 Hz, 1H, dd, H-5), 3.60 (J = 11.3, 11.4 Hz, 1H, dd, H-5), 3.46 (J = 3.4, 11.1 Hz, 1H, dd, H-9), 3.29 (J = 6.8, 11.1 Hz, 1H, dd, H-9), 2.71 (J = 4.8, 11.4, 11.4 Hz, 1H, ddd, H-8), 2.34 (3H, s, H-12), 2.28 (J = 0.8 Hz, 3H, d, H-1), 2.18 – 2.02 (3H, m, H-6 and H-7); $^{13}\text{C-NMR}$ (CDCl_3 , 75 MHz): δ 152.4, 152.0, 140.1, 136.3, 129.4, 127.2, 107.4, 105.9, 73.1, 71.1, 62.2, 43.6, 43.3, 37.5, 21.0, 13.5; *IR:* $\bar{\nu}$ 3402 (O-H), 2943, 2918, 2857, 1565, 1514, 1435, 1378, 1335, 1220, 1129, 1109, 1074, 1048, 1018, 942, 816, 782, 587, 549, 508; *R_f* (diethyl ether) 0.79; *Mass Spectrometry:* TOF ES⁺: MH⁺: Expected: *m/z* 287.1647, Observed: *m/z* 287.1637, Difference = -3.48 ppm

Synthesis of ((3S,4S,6S)-4-(4-chlorophenyl)-6-(5-methylfuran-2-yl)tetrahydro-2H-pyran-3-yl)methanol (288k)

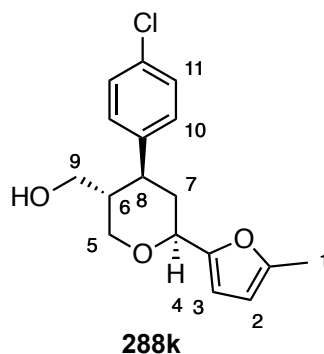

Experimental procedure followed matched that described for **288b** using:

3-(4-chlorophenyl)-4-(hydroxymethyl)-1-(5-methylfuran-2-yl)pentane-1,5-diol

(**287k**) (19.7 mg, 0.0607 mmol), Quadrapure™ polymer-supported sulfonic acid (12.3 mg) and acetonitrile (2.50 mL). The product was a pale yellow oil.

Yield: 83% (15.4 mg, 0.0502 mmol); *Diastereomeric Ratio:* 10:1; $^1\text{H-NMR}$ (CDCl_3 , 300 MHz): δ 7.33 – 7.29 (2H, m, H-11), 7.22 – 7.17 (2H, m, H-10), 6.15 (J = 3.1 Hz, 1H, d, H-3), 5.90 (J = 0.9, 3.1 Hz, 1H, dd, H-2), 4.47 (J = 3.2, 10.4 Hz, 1H, dd, H-4), 4.35 (J = 4.4, 11.5 Hz, 1H, dd, H-5), 3.63 (J = 11.3, 11.5 Hz, 1H, dd, H-5), 3.45 (J = 3.3, 11.0 Hz, 1H, dd, H-9), 3.31 (J = 6.7, 11.0 Hz, 1H, dd, H-9), 2.82 – 2.73 (1H, m, H-8), 2.28 (J = 0.9 Hz, 3H, d, H-1), 2.10 – 2.01 (3H, m, H-6 and H-7); $^{13}\text{C-NMR}$ (CDCl_3 , 75 MHz): δ 152.2, 152.1, 141.7, 132.4, 128.9, 128.8, 107.6, 106.0, 73.0, 71.1, 61.9, 43.3, 43.2, 37.4, 13.6; *IR:* $\bar{\nu}$ 3391 (O-H), 2945, 2919, 2855, 1564, 1491, 1378, 1336, 1221, 1129, 1085, 1048, 1013, 942, 909, 825, 784, 730, 649, 634, 573, 494; *R_f* (diethyl ether) 0.77; *Mass Spectrometry:* TOF ES⁺: MH⁺: Expected: *m/z* 307.1101, Observed: *m/z* 307.1069, Difference = -10.42 ppm

5.6. Data from the Synthesis of 4-Aryl-2,6-Difuranyl Tetrahydropyrans

Synthesis of 1,5,-di(furan-2-yl)-3-(4-methoxyphenyl)pentane-1,5-dione (294c)

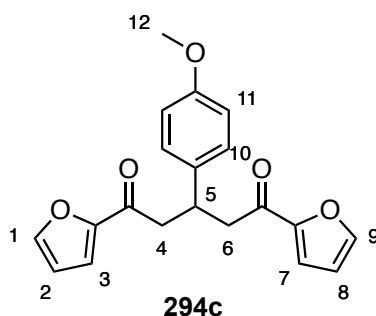

2-acetylfuran (**274**) (0.525 g, 4.77 mmol, 1.00 eqv.) was dissolved in methanol (45.0 mL). (*E*)-1-(furan-2-yl)-3-(4-methoxyphenyl)prop-2-en-1-one (**272c**) (1.10 g, 4.82 mmol, 1.01 eqv.) was then added, followed by 5% aqueous sodium hydroxide solution (6.00 mL). The reaction was stirred at reflux for 5 hours. Once the reaction had gone to completion it was diluted with diethyl ether (50.0 mL) and ammonium chloride solution (100 mL). Extraction was performed using diethyl ether (4 × 40.0 mL) and the combined organic phases were then washed with water (2 × 100 mL) and brine (2 × 100 mL). The organic material was then dried over magnesium sulfate before being concentrated under reduced pressure. The crude material was purified by column chromatography using a graduated solvent system reaching a 1:1 mixture of dichloromethane and diethyl ether. The product was a thick brown gum.

Yield: 41% (0.654 g, 1.93 mmol); $^1\text{H-NMR}$ (CDCl_3 , 300 MHz): δ 7.54 (J = 1.7 Hz, 2H, d, H-1 and H-9), 7.19 (J = 8.6 Hz, 2H, d, H-10), 7.18 (J = 3.5 Hz, 2H, d, H-3 and H-7), 6.78 (J = 8.6 Hz, 2H, d, H-11), 6.49 (J = 1.7, 3.5 Hz, 2H, dd, H-2 and H-8), 4.02 – 3.93 (1H, m, H-5), 3.73 (3H, s, H-12), 3.22 (J = 7.4, 7.4 Hz, 4H, dd, H-4 and H-6); $^{13}\text{C-NMR}$ (CDCl_3 , 75 MHz): δ 187.6 (C=O), 158.2, 152.6, 146.4, 135.1, 128.3, 117.4, 113.9, 112.2, 55.1, 44.7, 36.4; *IR:* $\bar{\nu}$ 3129, 2933, 2835, 1664 (C=O), 1608, 1565, 1510, 1463, 1392, 1284, 1244, 1177, 1084, 1026, 882, 829, 760, 593, 530; R_f (dichloromethane) 0.19; *Mass Spectrometry:* TOF ES⁺: MH⁺: Expected: m/z 339.1233, Observed: m/z 339.1236, Difference = -0.88 ppm

Synthesis of 1,5-di(furan-2-yl)-3-p-tolylpentane-1,5-dione (**294d**)

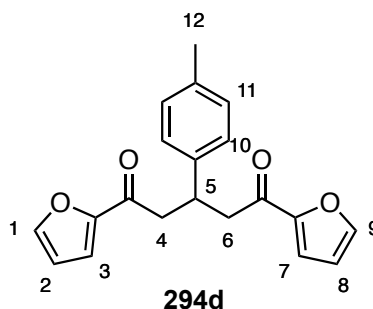

Experimental procedure followed matched that described for **294c** using:

2-acetylfuran (**274**) (0.667 g, 6.06 mmol, 1.26 eqv.), (*E*)-1-(furan-2-yl)-3-p-tolylprop-2-en-1-one (**272d**) (1.02 g, 4.81 mmol, 1.00 eqv.), 5% aqueous sodium hydroxide (5.00 mL) and methanol (50.0 mL). The product was a dark brown oil.

Yield: 58% (0.912 g, 2.81 mmol); $^1\text{H-NMR}$ (CDCl_3 , 300 MHz): δ 7.54 (J = 1.7 Hz, 2H, d, H-1 and H-9), 7.18 (J = 3.6 Hz, 2H, d, H-3 and H-7), 7.17 (J = 7.6 Hz, 2H, d, H-10), 7.07 (J = 7.6 Hz, d, H-11), 6.45 (J = 1.7, 3.6 Hz, 2H, dd, H-2 and H-8), 4.04

– 3.94 (1H, m, H-5), 3.31 – 3.18 (4H, m, H-4 and H-6); $^{13}\text{C-NMR}$ (CDCl_3 , 75 MHz): δ 187.6 (C=O), 152.6, 146.3, 140.1, 136.3, 129.2, 127.2, 117.3, 112.2, 44.6, 36.7, 21.0; *IR*: $\bar{\nu}$ 3130, 2921, 1732, 1666 (C=O), 1566, 1514, 1464, 1393, 1243, 1156, 1014, 911, 883, 816, 761, 730, 594, 551, 493; R_f (dichloromethane) 0.21; *Mass Spectrometry*: TOF ES^+ : MH^+ : Expected: m/z 323.1283, Observed: m/z 323.1282, Difference = 0.31 ppm

Synthesis of 3-(4-bromophenyl)-1,5-di(furan-2-yl)pentane-1,5-dione (**294f**)

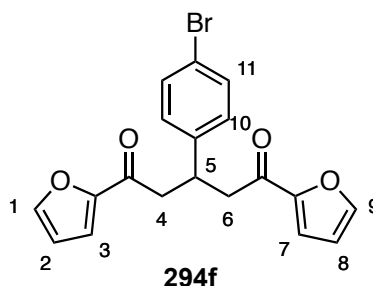

Experimental procedure followed matched that described for **294c** using:

2-acetylfuran (**274**) (0.397 g, 3.61 mmol, 1.00 eqv.), (*E*)-3-(4-bromophenyl)-1-(furan-2-yl)prop-2-en-1-one (**272f**) (1.08 g, 3.90 mmol, 1.08 eqv.), 5% aqueous sodium hydroxide (5.00 mL) and methanol (45.0 mL). The product was a brown crystalline solid.

Yield: 53% (0.740 g, 1.91 mmol); $^1\text{H-NMR}$ (CDCl_3 , 300 MHz): δ 7.55 (J = 1.7 Hz, 2H, d, H-1 and H-9), 7.38 (J = 8.5 Hz, 2H, d, H-10), 7.18 (J = 3.6 Hz, 2H, d, H-3 and H-7), 7.17 (J = 8.5 Hz, 2H, d, H-11), 6.51 (J = 1.7, 3.6 Hz, 2H, dd, H-2 and H-8), 4.00 (J = 7.1, 7.1, 7.2, 7.2 Hz, 1H, dddd, H-5), 3.31 – 3.16 (4H, m, H-4 and H-6); $^{13}\text{C-NMR}$ (CDCl_3 , 75 MHz): δ 187.1 (C=O), 152.5, 146.5, 142.2, 131.6, 129.2, 120.5, 117.4, 112.3, 44.2, 36.3; *IR*: $\bar{\nu}$ 3129, 1667 (C=O), 1566, 1487, 1465, 1393,

1288, 1155, 1072, 1009, 883, 825, 761, 593, 545; *Melting Point*: 58 °C; R_f (dichloromethane) 0.26; *Mass Spectrometry*: TOF ES⁺: MH⁺: Expected: m/z 387.0232, Observed: m/z 387.0230, Difference = 0.52 ppm

Synthesis of 1,5-di(furan-2-yl)-3-(4-methoxyphenyl)pentane-1,5-diol (**293c**)

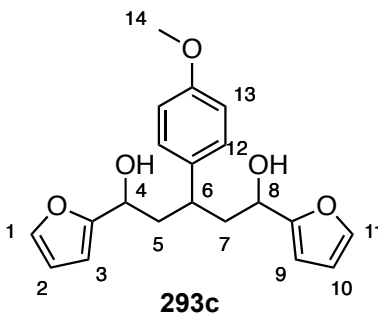

1,5-di(furan-2-yl)-3-(4-methoxyphenyl)pentane-1,5-dione (**294c**) (0.600 g, 1.77 mmol, 1.00 eqv.) was dissolved in methanol (30.0 mL) and the reaction mixture was cooled to -10°C . Sodium borohydride (0.808 g, 21.4 mmol, 12.6 eqv.) was added and the reaction mixture was stirred for 20 minutes whilst being allowed to warm to room temperature. After, the reaction mixture was concentrated to approximately 5.00 mL. This was then diluted with ethyl acetate (40.0 mL) and water (40.0 mL) whilst stirring. Extraction was accomplished using ethyl acetate (3 \times 30.0 mL) and the combined organic phases were then washed with brine (3 \times 70.0 mL). The organic material was then dried over magnesium sulfate before being concentrated under reduced pressure. The crude material was purified by column chromatography using a graduated solvent system approaching 100% diethyl ether. The product was a thick yellow gum.

Diastereomeric Ratio: 2:1; *Yield*: 56% (0.337 g, 0.984 mmol); $^1\text{H-NMR}$ (CDCl_3 , 300 MHz): δ 7.37 ($J = 1.7$ Hz, [2] 1H, d, H-1 [D-1]), 7.35 ($J = 1.7$ Hz, [2] 1H, d, H-11 [D-

1)), 7.31 (J = 2.1 Hz, 1H, d, H-1 [D-2]), 7.30 (J = 1.9 Hz, 1H, d, H-11 [D-2]), 7.11 (J = 8.7 Hz, [2] 2H, d, H-12 [D-1]), 7.02 (J = 8.7 Hz, 2H, d, H-12 [D-2]), 6.85 (J = 8.7 Hz, [2] 2H, d, H-13 [D-1]), 6.84 (J = 8.7 Hz, 2H, d, H-13 [D-2]), 6.32 (J = 1.7, 3.1 Hz, [2] 1H, dd, H-2 [D-1]), 6.30 (J = 1.7, 3.2 Hz, [2] 1H, dd, H-10 [D-1]), 6.29 – 6.28 (1H, m, H-2 [D-2]), 6.27 (J = 1.9, 3.2 Hz, 1H, dd, H-10 [D-2]), 6.17 (J = 3.1 Hz, [2] 1H, d, H-3 [D-1]), 6.15 (J = 3.2 Hz, [2] 1H, d, H-9 [D-1]), 6.13 (J = 2.7 Hz, 1H, d, H-3 [D-2]), 6.11 (J = 3.2 Hz, 1H, d, H-9 [D-2]), 4.55 – 4.46 ([2] 2H, m, H-4 [D-1] and H-8 [D-1]), 4.38 – 4.30 (2H, m, H-4 [D-2] and H-8 [D-2]), 3.80 ([2] 3H, s, H-14 [D-1]), 3.79 (3H, s, H-14 [D-2]), 2.93 – 2.83 ([2] 1H, m, H-6 [D-1]), 2.53 – 2.38 (1H, m, H-6 [D-2]), 2.30 – 1.92 ([2] 6H + 6H, m, H-5 [D-1], H-5 [D-2], H-7 [D-1], H-7 [D-2], OH [D-1], OH [D-2], OH [D-1] and OH [D-2]); $^{13}\text{C-NMR}$ (CDCl_3 , 75 MHz): δ 158.2, 156.9, 155.9, 155.8, 142.1, 141.8, 135.9, 135.5, 128.7, 128.4, 114.0, 110.1, 106.6, 105.5, 105.4, 65.9, 65.8, 65.2, 65.0, 55.2, 42.6, 42.5, 42.1, 41.7, 38.1, 37.5; *IR*: $\bar{\nu}$ 3372 (O-H), 2934, 2835, 1609, 1509, 1462, 1296, 1243, 1177, 1147, 1065, 1030, 1003, 914, 883, 829, 809, 733, 598, 561; R_f (1:1 petroleum ether : diethyl ether) 0.13; *Mass Spectrometry*: TOF ES⁺: MNa⁺: Expected: m/z 365.1365, Observed: m/z 365.1352, Difference = 3.56 ppm

Synthesis of 1,5-di(furan-2-yl)-3-p-tolylpentane-1,5-diol (293d)

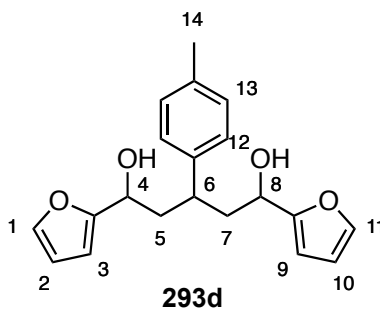

Experimental procedure followed matched that described for **293c** using:

1,5-di(furan-2-yl)-3-p-tolylpentane-1,5-dione (**294d**) (0.850 g, 2.62 mmol, 1.00 eqv.), sodium borohydride (0.619 g, 16.4 mmol, 6.26 eqv.) and methanol (45.0 mL). The product was a yellow foam.

Diastereomeric Ratio: 2.5:1; *Yield:* 51% (0.433 g, 1.33 mmol); $^1\text{H-NMR}$ (CDCl_3 , 300 MHz): δ 7.37 (J = 1.8 Hz [2.5] 1H, d, H-1 [D-1]), 7.36 (J = 1.8 Hz, [2.5] 1H, d, H-11 [D-1]), 7.31 (J = 1.9 Hz, 1H, d, H-1 [D-2]), 7.30 (J = 1.8 Hz, 1H, d, H-11 [D-2]), 7.15 – 7.10 ([2.5] 4H, m, H-12 [D-1] and H-13 [D-1]), 7.01 – 6.99 (4H, m, H-12 [D-2] and H-13 [D-2]), 6.33 – 6.30 ([2.5] 2H, m, H-2 [D-1] and H-10 [D-1]), 6.29 – 6.26 (2H, m, H-2 [D-2] and H-10 [D-2]), 6.18 (J = 3.2 Hz, [2.5] 1H, d, H-3 [D-1]), 6.16 (J = 3.3 Hz, [2.5] 1H, d, H-9 [D-1]), 6.14 – 6.11 (2H, m, H-3 [D-2] and H-9 [D-2]), 4.56 – 4.48 ([2.5] 2H, m, H-4 [D-1] and H-8 [D-1]), 4.40 – 4.31 (2H, m, H-4 [D-2] and H-8 [D-2]), 2.96 – 2.85 ([2.5] 1H, m, H-6 [D-1]), 2.51 – 2.45 (1H, m, H-6 [D-2]), 2.33 ([2.5] 3H, s, H-14 [D-1]), 2.33 (3H, s, H-14 [D-2]), 2.29 – 1.96 ([2.5] 6H + 6H, m, H-5 [D-1], H-5 [D-2], H-7 [D-1], H-7 [D-2], OH [D-1], OH [D-2], OH [D-1] and OH [D-2]); $^{13}\text{C-NMR}$ (CDCl_3 , 75 MHz): δ 156.9, 155.9, 155.9, 142.1, 141.8, 140.9, 140.5, 136.2, 136.1, 129.4, 127.6, 127.4, 110.1, 106.6, 105.4, 105.4, 65.9, 65.8, 65.2, 65.0, 42.6, 42.1, 41.6, 38.5, 37.9, 21.0; *IR:* $\bar{\nu}$ 3334 (O-H), 2921, 1512, 1228, 1147, 1065, 1003, 912, 883, 814, 725, 598, 562; *R_f* (1:1 petroleum ether : diethyl ether) 0.09; *Mass Spectrometry:* TOF ES⁺: MNa⁺: Expected: *m/z* 349.1416, Observed: *m/z* 349.1407, Difference = 2.58 ppm

Synthesis of (2R,4S,6S)-2,6-di(furan-2-yl)-4-(4-methoxyphenyl)tetrahydro-2H-pyran (**292c**)

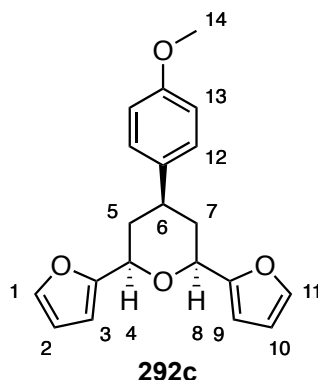

1,5-di(furan-2-yl)-3-(4-methoxyphenyl)pentane-1,5-diol (**293c**) (35.8 mg, 0.105 mmol) was dissolved in acetonitrile (5.00 mL). Quadrapure™ polymer-supported sulfonic acid (15.0 mg) was added and the reaction was stirred gently for 5 hours. After, the mixture was diluted with dichloromethane (10.0 mL) and petroleum ether (10.0 mL). This was then passed through a silica plug and the resulting solution was concentrated under reduced pressure. The crude material was purified by column chromatography using a graduated solvent system reaching a 1:1 mixture of petroleum ether and diethyl ether. The product obtained was a pale brown oil.

Diastereomeric Ratio: 10:1; *Yield:* 16% (5.4 mg, 0.0116 mmol); $^1\text{H-NMR}$ (CDCl_3 , 300 MHz): δ 7.37 (J = 1.6 Hz, 2H, d, H-1 and H-11), 7.22 (J = 8.7 Hz, 2H, d, H-12), 6.89 (J = 8.7 Hz, 2H, d, H-13), 6.34 – 6.30 (4H, m, H-2, H-3, H-9 and H-10), 4.76 (J = 3.2, 10.4 Hz, 2H, dd, H-4 and H-8), 3.81 (3H, s, H-14), 3.02 (J = 5.1, 5.1, 10.2, 10.2 Hz, 1H, dddd, H-6), 2.14 – 2.01 (4H, m, H-5 and H-7); $^{13}\text{C-NMR}$ (CDCl_3 , 75 MHz): δ 158.2, 154.1, 142.2, 136.9, 127.7, 114.0, 110.1, 107.0, 73.3, 55.3, 40.8, 36.6; R_f (1:1 petroleum ether : diethyl ether) 0.72; *Mass Spectrometry:* Decomposed rapidly – accurate mass unable to be obtained.

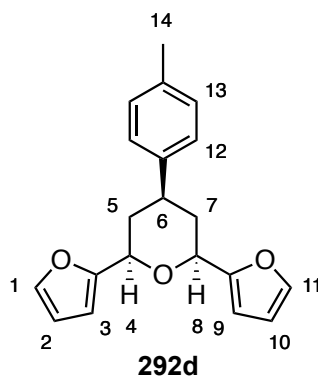
Synthesis of (2R,4S,6S)-2,6-di(furan-2-yl)-4-p-tolyltetrahydro-2H-pyran (292d)

Experimental procedure followed matched that described for **292c** using:

1,5-di(furan-2-yl)-3-*p*-tolylpentane-1,5-diol (**293d**) (0.163 g, 0.499 mmol), polymer-supported sulfonic acid (23.8 mg) and acetonitrile (15.0 mL). The product obtained was a yellow oil.

Diastereomeric Ratio: 20:1; *Yield*: 33% (51.3 mg, 0.166 mmol); ¹H-NMR (CDCl₃, 300 MHz): δ 7.37 (J = 1.5 Hz, 2H, d, H-1 and H-11), 7.24 – 7.18 (4H, m, H-12 and H-13), 6.37 – 6.33 (4H, m, H-2, H-3, H-9 and H-10), 4.81 – 4.77 (2H, m, H-4 and H-8), 3.14 – 3.00 (1H, m, H-6), 2.37 (3H, s, H-14), 2.17 – 2.06 (4H, m, H-5 and H-7); ¹³C-NMR (CDCl₃, 75 MHz): δ 154.1, 142.2, 141.7, 136.2, 129.3, 126.6, 110.0, 107.0, 73.3, 41.2, 36.4, 21.0; *IR*: $\bar{\nu}$ 2941, 2916, 2876, 1505, 1368, 1346, 1305, 1255, 1144, 1091, 1055, 1009, 981, 921, 811, 587, 553, 513; *R_f* (1:1 petroleum ether : diethyl ether) 0.79; *Mass Spectrometry*: TOF ES⁺: MH⁺: Expected: *m/z* 309.1491, Observed: *m/z* 309.1485, Difference = 1.94 ppm

Synthesis of (2R,4S,6S)-4-(4-bromophenyl)-2,6-di(furan-2-yl)tetrahydro-2H-pyran
(292f)

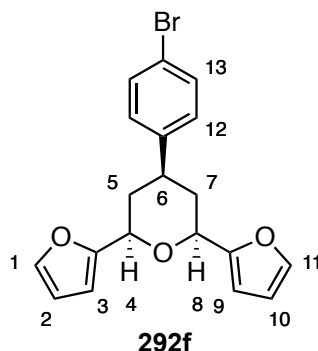

3-(4-bromophenyl)-1,5-di(furan-2-yl)pentane-1,5-dione (**294f**) (0.549 g, 1.42 mmol, 1.00 eqv.) was dissolved in methanol (30.0 mL) and the reaction mixture was cooled to -10°C . Sodium borohydride (0.676 g, 17.9 mmol, 12.0 eqv.) was added and the reaction mixture was stirred for 20 minutes whilst being allowed to warm to room temperature. After, the reaction mixture was concentrated to approximately 5.00 mL. This was then diluted with ethyl acetate (40.0 mL) and water (40.0 mL) whilst stirring. Extraction was accomplished using ethyl acetate (3×30.0 mL) and the combined organic phases were then washed with brine (3×70.0 mL). The organic material was then dried over magnesium sulfate before being concentrated under reduced pressure. The crude material was then dissolved in acetonitrile (25.0 mL). Quadrapure™ polymer-supported sulfonic acid (15.0 mg) was added and the reaction was stirred gently for 5 hours. After, the mixture was diluted with dichloromethane (10.0 mL) and petroleum ether (45.6 mL). This was then passed through a silica plug and the resulting solution was concentrated under reduced pressure. The crude material was purified by column chromatography using a graduated solvent system reaching a 1:1 mixture of petroleum ether and diethyl ether. The product obtained was a white solid.

Diastereomeric Ratio: 40:1; *Yield:* 19% over 2 steps (68.9 mg, 0.185 mmol); $^1\text{H-NMR}$ (CDCl_3 , 300 MHz): δ 7.48 (J = 8.5 Hz, 2H, d, H-12), 7.38 (J = 1.5 Hz, 2H, dd, H-1 and H-11), 7.18 (J = 8.5 Hz, 2H, d, H-13), 6.34 – 6.32 (4H, m, H-2, H-3, H-9 and H-10), 4.78 (J = 3.3, 10.2 Hz, 2H, dd, H-4 and H-8), 3.10 – 2.98 (1H, m, H-6), 2.17 – 2.06 (4H, m, H-5 and H-7); $^{13}\text{C-NMR}$ (CDCl_3 , 75 MHz): δ 153.8, 143.5, 142.2, 131.7, 128.5, 120.3, 110.1, 107.1, 73.2, 41.1, 36.2; *IR:* $\bar{\nu}$ 3143, 2943, 2921, 2853, 1490, 1318, 1150, 1062, 1009, 984, 808, 755, 740, 649, 598, 565, 543, 520, 436; *Melting Point:* 82 – 83 °C; R_f (1:1 petroleum ether : diethyl ether) 0.81; *Mass Spectrometry:* TOF ES⁺: MH⁺: Expected: m/z 373.0439, Observed: m/z 373.0438, Difference = 0.27 ppm

Synthesis of 5,5-di(furan-2-yl)-3-p-tolylpentanal (**295**)

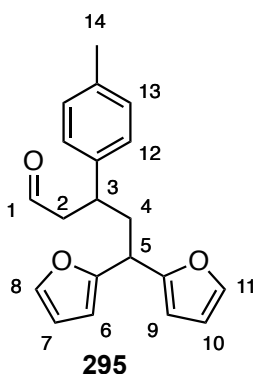

This aldehyde is the major impurity seen during the cyclisation reaction to synthesise **292d**.

$^1\text{H-NMR}$ (CDCl_3 , 300 MHz): δ 9.57 (J = 2.1 Hz, 1H, t, H-1), 7.38 (J = 1.9 Hz, 1H, d, H-8), 7.27 (J = 2.0 Hz, 1H, d, H-11), 7.15 – 7.06 (4H, m, H-12 and H-13), 6.36 (J = 1.9, 3.2 Hz, 1H, dd, H-7), 6.25 (J = 2.0, 3.12 Hz, 1H, dd, H-10), 6.12 (J = 3.2 Hz, 1H, d, H-6), 5.95 (J = 3.2 Hz, 1H, d, H-9), 3.85 – 3.76 (2H, m, H-2), 3.10 – 2.98

(2H, m, H-3 and H-5), 2.69 (J = 2.1, 2.8, 7.1 Hz, 2H, ddd, H-4), 2.33 (3H, s, H-14);
¹³C-NMR (CDCl₃, 75 MHz): δ 201.7 (C=O), 155.4, 153.8, 141.7, 141.3, 139.2,
136.5, 129.5, 127.5, 110.2, 110.1, 106.9, 105.2, 50.6, 38.9, 37.2, 36.3, 21.0; *Mass Spectrometry*: TOF ES⁺: MH⁺: Expected: *m/z* 309.1491, Observed: *m/z* 309.1493,
Difference = -0.65 ppm

5.7. Data for the Continuous-Flow Test Reactions and Bromination of Enaminones

Synthesis of (*E*)-methyl 2-benzylidenehydrazinecarboxylate (**317**)

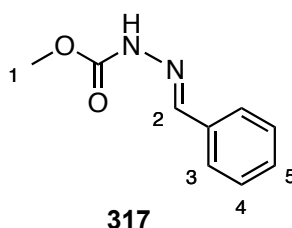

0.5 M methyl carbazate (**316**) solution in dichloromethane (0.500 mL, 0.250 mmol, 2.00 eqv.) was added to 0.25 M benzaldehyde (**56**) solution in dichloromethane (0.500 mL, 0.125 mmol, 1.00 eqv.). To this was added 0.03 M pyridinium *p*-toluenesulfonate solution in dichloromethane (0.500 mL, 0.0159 mmol, 0.127 eqv.). The reaction was allowed to react for two minutes. After this time had elapsed the reaction was quenched by the addition of 1 M aqueous phosphoric acid (1.50 mL). This was rapidly shaken for thirty seconds and then the organic phase was concentrated under reduced pressure and subsequently characterised by $^1\text{H-NMR}$.

Yield: 95% (0.0212 g, 0.119 mmol); $^1\text{H-NMR}$: (CDCl_3 , 300 MHz) δ 9.03 (1H, br, NH), 7.91 (1H, s, H-2), 7.66 – 7.34 (5H, m, H-3, H-4 and H-5), 3.85 (3H, s, H-1); Data in accordance with literature values.¹²

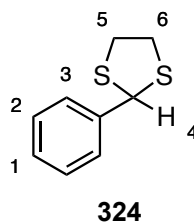
Synthesis of 2-phenyl-1,3-dithiane (324)

0.5 M benzaldehyde (**56**) solution in dichloromethane (0.500 mL, 0.250 mmol, 1.00 eqv.) was added to solution of 0.75 M $\text{BF}_3 \cdot \text{THF}$ (0.500 mL, 0.375 mmol, 1.50 eqv.) and 1 M 1,2-ethanedithiol (**323**) in dichloromethane (0.500 mL, 0.500 mmol, 2.00 eqv.). The reaction was allowed to react for one minute. After this time had elapsed the reaction was quenched by the addition of 2 M aqueous sodium hydroxide solution (1.00 mL). This was rapidly shaken for thirty seconds and then the organic phase was concentrated under reduced pressure and subsequently characterised by $^1\text{H-NMR}$.

$^1\text{H-NMR}$: (CDCl_3 , 300 MHz) δ 7.54 – 7.27 (5H, m, H-1, H-2 and H-3), 5.64 (1H, s, H-4), 3.57 – 3.50 (2H, m, H-5 and H-6), 3.41 – 3.31 (2H, m, H-5' and H-6'); Data in accordance with literature values.¹³

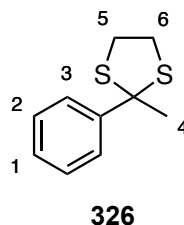
Synthesis of 2-methyl-2-phenyl-1,3-dithiolane (326)

1 M acetophenone (**325**) solution in dichloromethane (0.500 mL, 0.500 mmol, 1.00 eqv.) was added to solution of 3 M $\text{BF}_3 \cdot \text{THF}$ (0.500 mL, 1.50 mmol, 3.00 eqv.) and

4 M 1,2-ethanedithiol (**323**) in dichloromethane (0.500 mL, 2.00 mmol, 4.00 eqv.). The reaction was allowed to react for two minutes. After this time had elapsed the reaction was quenched by the addition of 2 M aqueous sodium hydroxide solution (4.00 mL). This was rapidly shaken for thirty seconds and then the organic phase was concentrated under reduced pressure and subsequently characterised by ¹H-NMR.

¹H-NMR: (CDCl₃, 300 MHz) δ 7.80 – 7.22 (5H, m, H-1, H-2 and H-3), 3.54 – 3.32 (4H, m, H-5 and H-6), 2.18 (3H, s, H-4); Data in accordance with literature values.¹⁴

Synthesis of 3-[(4-chlorobenzyl)amino]cyclohex-2-enone (**331a**)¹⁵

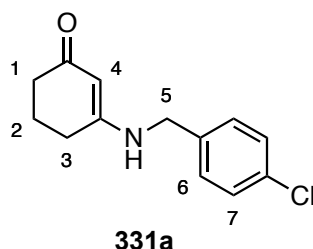

Cyclohexanedione (**329b**) (1.55 g, 13.8 mmol, 1.00 eqv.) and 4-chlorobenzylamine (1.80 mL, 14.8 mmol, 1.07 eqv.) were added to a flask under nitrogen. To this was added toluene (50.0 mL) and ethanol (2.50 mL) and the reaction was stirred at reflux for three hours. Solvent was then removed under concentrated pressure and the product was recrystallised in toluene. The product a yellow crystalline material.

Yield: 71% (2.31 g, 9.80 mmol); ¹H-NMR: (CDCl₃, 300 MHz) δ 7.32 – 7.26 (2H, m, H-7), 7.18 (J = 8.5 Hz, 2H, m, H-6), 5.34 (1H, s, NH), 5.07 (1H, s, H-4), 4.18 (J =

5.4 Hz, 2H, d, H-5), 2.38 (J = 6.2 Hz, 2H, t, H-1), 2.27 (J = 6.5 Hz, 2H, t, H-3), 1.99 – 1.91 (2H, m, H-2); *Melting Point*: 167 – 168 °C (*Literature value*: 170 – 172 °C); Data in accordance with literature values.¹⁵

Synthesis of 3-(4-chlorobenzylamino)-5,5-dimethylcyclohex-2-enone (331b)

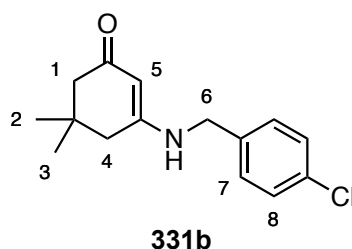

Experimental procedure followed matched that described for **331a** using:

Dimedone (**329a**) (1.51 g, 10.8 mmol, 1.00 eqv.), 4-chlorobenzylamine (1.60 mL, 13.2 mmol, 1.22 eqv.), ethanol (2.50 mL) and toluene (50.0 mL). The product was a pale yellow crystalline solid.

Yield: 88% (2.50 g, 9.48 mmol); ¹H-NMR: (CDCl₃, 300 MHz) δ 7.30 – 7.26 (2H, m, H-8), 7.17 (J = 8.3 Hz, 2H, d, H-7), 5.42 (1H, s, NH), 5.04 (1H, s, H-5), 4.19 (J = 5.4 Hz, 2H, d, H-6), 2.22 (2H, s, H-1), 2.12 (2H, s, H-4), 1.04 (6H, s, H-2 and H-3); *Melting Point*: 157 – 159 °C (*Literature Value*: 159 – 169 °C); Data in accordance with literature values.¹⁵

Synthesis of (Z)-4-(4-chlorobenzylamino)pent-3-en-2-one (331c)

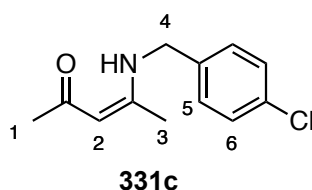

The procedure followed matched that described for **331a** using:

2,4-pentanedione (**329c**) (1.60 mL, 15.6 mmol, 1.00 eqv.), 4-chlorobenzylamine (2.20 mL, 18.1 mmol, 1.16 eqv.), ethanol (2.50 mL) and toluene (50.0 mL). The product was an off-white crystalline solid.

Yield: 50% (1.74 g, 7.78 mmol); *¹H-NMR:* (CDCl₃, 300 MHz) δ 11.12 (1H, s, NH), 7.27 (J = 8.1 Hz, 2H, d, H-6), 7.15 (J = 8.1 Hz, 2H, d, H-5), 5.03 (1H, s, H-2), 4.39 (J = 6.2 Hz, 2H, d, H-4), 2.01 (3H, s, H-3), 1.86 (3H, s, H-1); *Melting Point:* 81 – 82 °C; Data in accordance with literature values.¹⁶

Synthesis of 3-(cyclohexylamino)cyclohex-2-enone (**331d**)

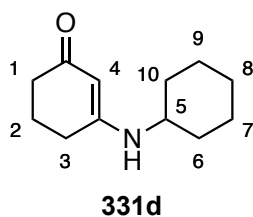

The procedure followed matched that described for **331a** using:

Cyclohexanedione (**329b**) (1.52 g, 13.6 mmol, 1.00 eqv.), cyclohexylamine (2.00 mL, 17.5 mmol, 1.29 eqv.), ethanol (3.00 mL) and toluene (50.0 mL). The product was a yellow crystalline solid.

Yield: 91% (2.39 g, 12.4 mmol); *¹H-NMR:* (CDCl₃, 300 MHz) δ 5.89 (J = 7.3 Hz, 1H, d, NH), 5.00 (1H, s, H-4), 3.14 – 3.05 (1H, m, H-5), 2.26 (J = 6.2 Hz, 2H, t, H-1), 2.16 (J = 6.4 Hz, 2H, t, H-3), 1.88 – 0.97 (12H, m, H-2, H-6, H-7, H-8, H-9 and H-10); *Melting Point:* 152 – 154 °C (*Literature Value:* 155 – 156 °C); Data in accordance with literature values.¹⁷

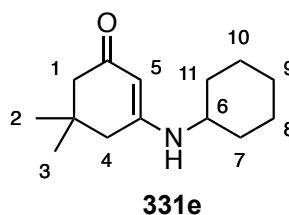
Synthesis of 3-(cyclohexylamino)-5,5-dimethylcyclohex-2-enone (**331e**)

The procedure followed matched that described for **331a** using:

Dimedone (**329a**) (1.62 g, 11.6 mmol, 1.00 eqv.), cyclohexylamine (1.60 mL, 14.1 mmol, 1.22 eqv.), ethanol (2.50 mL) and toluene (50.0 mL). The product was a yellow crystalline material.

Yield: 96% (2.46 g, 11.1 mmol); *¹H-NMR:* (CDCl₃, 300 MHz) δ 5.52 (1H, s, NH), 5.04 (1H, s, H-5), 3.15 (1H, s, H-6), 2.13 (2H, s, H-1), 2.08 (2H, s, H-4), 1.93 – 1.11 (10H, m, H-7, H-8, H-9, H-10 and H-11), 0.97 (6H, s, H-2 and H-3); *Melting Point:* 173 – 174 °C (*Literature Value:* 170 – 172 °C); Data in accordance with literature values.¹⁸

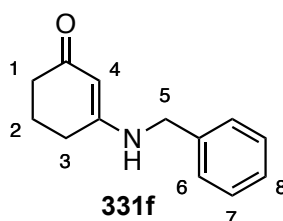
Synthesis of 3-(benzylamino)cyclohex-2-enone (**331f**)

The procedure followed matched that described for **331a** using:

Cyclohexandione (**329b**) (1.51 g, 13.5 mmol, 1.00 eqv.), benzylamine (**319**) (1.80 mL, 16.5 mmol, 1.22 eqv.), ethanol (2.50 mL) and toluene (50.0 mL). The product was a yellow solid.

Yield: 81% (2.21 g, 11.0 mmol); ¹H-NMR: (CDCl₃, 400 MHz) δ 7.35 – 7.19 (5H, m, H-6, H-7 and H-8), 6.31 (1H, s, NH), 5.06 (1H, s, H-4), 4.17 (2H, s, H-5), 2.38 (J = 6.1 Hz, 2H, t, H-1), 2.21 (J = 5.7 Hz, 2H, t, H-3), 1.98 – 1.83 (2H, m, H-2); *Melting Point:* 124 – 126 °C; Data in accordance with literature values.¹⁹

Synthesis of 3-(benzylamino)-5,5-dimethylcyclohex-2-enone (**331g**)

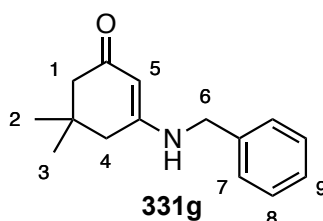

The procedure followed matched that described for **331a** using:

Dimedone (**329a**) (1.52 g, 10.8 mmol, 1.00 eqv.), benzylamine (**319**) (1.40 mL, 12.8 mmol, 1.19 eqv.), ethanol (2.50 mL) and toluene (50.0 mL). The product was an orange solid.

Yield: 90% (2.22 g, 9.68 mmol); ¹H-NMR: (CDCl₃, 400 MHz) δ 7.38 – 7.24 (5H, m, H-7, H-8 and H-9), 5.58 (1H, s, NH), 5.12 (1H, s, H-5), 4.22 (2H, s, H-6), 2.24 (2H, s, H-1), 2.13 (2H, s, H-4), 1.06 (6H, s, H-2 and H-3); *Melting Point:* 130 – 131 °C (*Literature Value:* 127 – 128 °C); Data in accordance with literature values.²⁰

Synthesis of (Z)-4-(benzylamino)pent-3-en-2-one (**331h**)

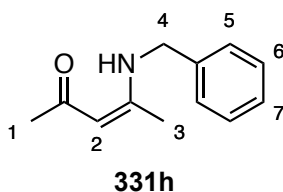

The procedure followed matched that described for **331a** using:

2,4-pentanedione (**329c**) (1.60 mL, 15.6 mmol, 1.00 eqv.), benzylamine (**319**) (2.00 mL, 18.3 mmol, 1.17 eqv.), ethanol (3.00 mL) and toluene (50.0 mL). The product was an amber oil.

Yield: 88% (2.60 g, 13.7 mmol); ¹H-NMR: (CDCl₃, 300 MHz) δ 11.17 (1H, s, NH), 7.31 – 7.19 (5H, m, H-5, H-6 and H-7), 5.02 (1H, s, H-2), 4.35 (J = 6.4 Hz, 2H, d, H-4), 2.00 (3H, s, H-3), 1.84 (3H, s, H-1); Data in accordance with literature values.²¹

Synthesis of 3-(sec-butylamino)-5,5-dimethylcyclohex-2-enone (**331i**)

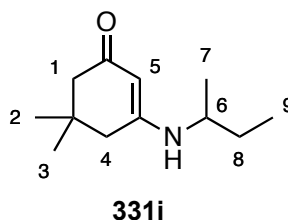

The procedure followed matched that described for **331a** using:

Dimedone (**329a**) (1.56 g, 11.1 mmol, 1.00 eqv.), sec-butylamine (1.80 mL, 17.8 mmol, 1.60 eqv.), ethanol (2.50 mL) and toluene (50.0 mL). The product was a yellow solid.

Yield: 93% (2.02 g, 10.3 mmol); ¹H-NMR: (CDCl₃, 400 MHz) δ 5.09 – 5.00 (2H, m, H-5 and NH), 3.40 – 3.28 (1H, m, H-6), 2.15 (2H, s, H-1), 2.13 (2H, s, H-4), 1.57 – 1.51 (1H, m, H-8), 1.51 – 1.37 (1H, m, H-8'), 1.13 (J = 5.8 Hz, 3H, d, H-7), 1.02 (6H, s, H-2 and H-3), 0.87 (J = 6.9 Hz, 3H, t, H-9); ¹³C-NMR: (CDCl₃, 100 MHz) δ 196.5 (C=O), 162.6, 95.1, 50.0, 49.7, 43.8, 32.7, 28.9, 28.2, 28.1, 19.5, 10.2; IR: $\bar{\nu}$

3246 (N-H), 3078, 2963, 2924, 2873, 1525 (C=O), 1449, 1385, 1364, 1345, 1271, 1253, 1223, 1148, 731, 604, 547; *Melting Point*: 113 – 115 °C; *R_f* (ethyl acetate) 0.37; *Mass Spectrometry*: TOF ES⁺: MH⁺: Expected: *m/z* 196.1701, Observed: *m/z* 196.1701, Difference = 0.00 ppm

Synthesis 3-(2-bromobenzylamino)-5,5-dimethylcyclohex-2-enone (331j)

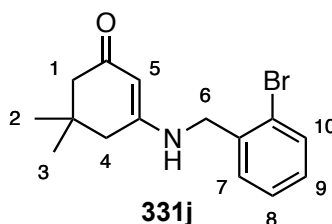

Experimental procedure followed matched that described for **331a** using:

Dimedone (**329a**) (1.52 g, 10.8 mmol, 1.00 eqv.), 2-bromobenzylamine (1.80 mL, 14.3 mmol, 1.32 eqv.), ethanol (2.00 mL) and toluene (50.0 mL). The product was a yellow solid.

Yield: 87% (2.91 g, 9.44 mmol); ¹H-NMR: (CDCl₃, 400 MHz) δ 7.55 (J = 7.5 Hz, 1H, d, H-10), 7.30 – 7.24 (2H, m, H-7 and H-8), 7.16 (J = 7.5 Hz, 1H, t, H-9), 5.21 (1H, s, NH), 5.09 (1H, s, H-5), 4.32 (J = 4.0 Hz, 2H, d, H-6), 2.24 (2H, s, H-1), 2.15 (2H, s, H-4), 1.06 (6H, s, H-2 and H-3); ¹³C-NMR: (CDCl₃, 100 MHz) δ 196.9 (C=O), 162.3, 135.7, 133.1, 129.4, 129.4, 127.7, 123.5, 96.5, 50.3, 47.4, 43.4, 32.9, 28.2; *IR*: ν̄ 3219 (N-H), 3010, 2936, 2900, 2867, 1576, 1552, 1429, 1364, 1281, 1241, 1172, 1154, 1128, 1026, 1005, 811, 775, 750, 741, 638, 614, 571, 553; *Melting Point*: 171 – 172 °C; *R_f* (ethyl acetate) 0.31; *Mass Spectrometry*: TOF ES⁺: MH⁺: Expected: *m/z* 308.0650, Observed: *m/z* 308.0651, Difference = -0.32 ppm

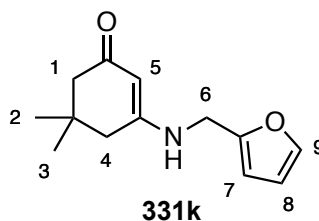
Synthesis of 3-(furan-2-ylmethylamino)cyclohex-2-enone (**331k**)

The procedure followed matched that described for compound **331a** using:

Dimedone (**329a**) (1.66 g, 11.8 mmol, 1.00 eqv.), furfurylamine (1.40 mL, 15.8 mmol, 1.34 eqv.), ethanol (2.50 mL) and toluene (50.0 mL). The product was an off-white crystalline material.

Yield: 83% (2.14 g, 9.76 mmol); *¹H-NMR:* (CDCl₃, 300 MHz) δ 7.35 (J = 1.9 Hz, 1H, d, H-9), 6.32 (J = 1.9, 3.2 Hz, 1H, dd, H-8), 6.25 (J = 3.2 Hz, 1H, d, H-7), 5.18 (1H, s, H-5), 5.05 (1H, s, NH), 4.23 (J = 5.1 Hz, 2H, d, H-6), 2.19 (2H, s, H-1), 2.16 (2H, s, H-4), 1.05 (6H, s, H-2 and H-3); *Melting Point:* 153 – 154 °C (*Literature Value:* 148 – 150 °C); Data in accordance with literature values.²²

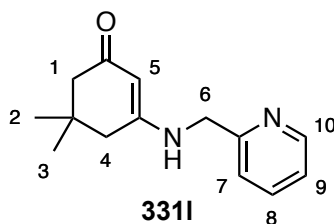
Synthesis of 3-(pyridine-2-ylmethylamino)cyclohex-2-enone (**331l**)

The procedure followed matched that described for **331a** using:

Dimedone (**329a**) (1.59 g, 11.3 mmol, 1.00 eqv.), 2-picolylamine (1.60 mL, 15.5 mmol, 1.37 eqv.), ethanol (2.50 mL) and toluene (50.0 mL). The product was a yellow crystalline solid.

Yield: 86% (2.24 g, 9.73 mmol); $^1\text{H-NMR}$: (CDCl_3 , 300 MHz) δ 8.48 (J = 4.5 Hz, 1H, d, H-10), 7.63 (J = 7.7, 7.7 Hz, 1H, dd, H-8), 7.20 – 7.15 (2H, m, H-7 and H-9), 6.42 (1H, s, NH), 5.06 (1H, s, H-5), 4.30 (J = 4.6 Hz, 2H, d, H-6), 2.28 (2H, s, H-1), 2.12 (2H, s, H-4), 1.02 (6H, s, H-2 and H-3); *Melting Point:* 121 – 122 °C (*Literature Value:* 160 – 161 °C); Data in accordance with literature values.²²

Synthesis of 3-(sec-butylamino)cyclohex-2-enone (**331m**)

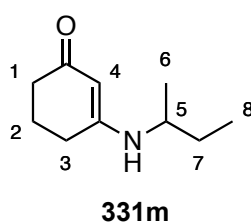

The procedure followed matched that described for **331a** using:

Cyclohexanedione (**329b**) (1.56 g, 13.9 mmol, 1.00 eqv.), *sec*-butylamine (1.80 mL, 17.8 mmol, 1.28 eqv.), ethanol (2.50 mL) and toluene (50.0 mL). The product was an orange/brown solid.

Yield: 35% (0.811 g, 4.84 mmol); $^1\text{H-NMR}$: (CDCl_3 , 400 MHz) δ 5.07 (1H, s, H-4), 4.92 (1H, s, NH), 3.37 – 3.28 (1H, m, H-5), 2.32 (J = 6.7 Hz, 2H, d, H-1), 2.26 (J = 5.8 Hz, 2H, d, H-3), 1.96 – 1.87 (2H, m, H-2), 1.64 – 1.49 (1H, m, H-7), 1.49 – 1.39 (1H, m, H-7') 1.12 (J = 6.2 Hz, 3H, d, H-6), 0.87 (J = 7.2 Hz, 3H, t, H-8); $^{13}\text{C-NMR}$: (CDCl_3 , 100 MHz) δ 197.0 (C=O), 163.7, 96.5, 49.6, 36.3, 30.0, 28.9, 21.9, 19.4, 10.2; *IR*: $\bar{\nu}$ 3253 (N-H), 3086, 2966, 2935, 2874, 1532 (C=O), 1455, 1428, 1369, 1300, 1252, 1189, 1147, 1108, 1003, 799, 785, 729, 671, 607, 599; *Melting Point:* 74 – 756 °C; R_f (ethyl acetate) 0.19; *Mass Spectrometry:* TOF ES^+ : MH^+ : Expected: m/z 168.1388, Observed: m/z 168.1391, Difference = -1.78 ppm

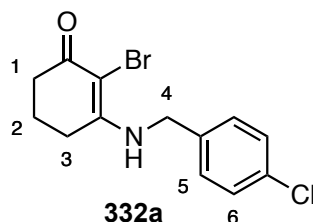
Synthesis of 2-bromo-3-(4-chlorobenzylamino)cyclohex-2-enone (332a)

3-[(4-chlorobenzyl)amino]cyclohex-2-enone (**331a**) (0.100 M) was passed through a 3.00 mL loop to reach a reaction loop of 4.70 mL at 1.10 mL min⁻¹. Here it was combined with *N*-bromosuccinimide (NBS) (0.105 M), which had been passed through a 4.10 mL loop at 0.900 mL min⁻¹ beginning 20 seconds prior to the enaminone flow. Upon reaching the end of the reaction loop the organic reaction mixture joined with an aqueous stream of 0.1 M sodium thiosulfate/potassium carbonate, flowing at 4.00 mL min⁻¹. This passed through a mixing chamber where the two phases were mixed using several magnetic stirrer bars above a stirrer hotplate. After this the solutions reached a separation chamber where the phases were separately collected. The organic phase was concentrated under reduced pressure yielding a brown solid.

Yield: 93% (87.5 mg, 0.278 mmol); ¹H-NMR: (CDCl₃, 400 MHz) δ 7.32 (J = 7.6 Hz, 2H, d, H-6), 7.18 (J = 7.6 Hz, 2H, d, H-5), 6.12 (1H, s, NH), 4.49 (J = 5.2 Hz, 2H, d, H-4), 2.51 (J = 6.3 Hz, 2H, t, H-1), 2.45 (J = 6.0 Hz, 2H, t, H-3), 1.98 – 1.84 (2H, m, H-2); ¹³C-NMR: (CDCl₃, 100 MHz) δ 187.8 (C=O), 161.0, 135.6, 133.7, 129.2, 128.0, 96.6, 46.5, 36.6, 26.7, 20.7; *IR*: $\bar{\nu}$ 3260 (N-H), 2988, 2955, 2939, 2901, 2884, 1584, 1573, 1520, 1489, 1440, 1390, 1313, 1294, 1255, 1194, 1176, 1102, 1086, 1009, 910, 800, 715, 659, 587, 571; *Melting Point*: 122 °C; *R_f* (ethyl acetate)

0.65; *Mass Spectrometry*: TOF ES⁺: MH⁺: Expected: *m/z* 313.9947, Observed: *m/z* 313.9939, Difference = 2.55 ppm

Synthesis of 2-bromo-3-(4-chlorobenzylamino)-5,5-dimethylcyclohex-2-enone
(332b)

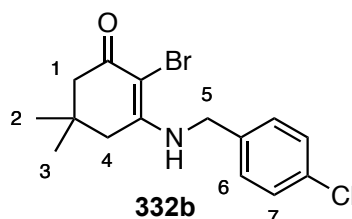

The procedure followed matched that described for **332a** using:

3-(4-chlorobenzylamino)-5,5-dimethylcyclohex-2-enone (**331b**) (0.100 M) was passed through a 3.00 mL loop to reach a reaction loop of 4.70 mL at 0.900 mL min⁻¹ and *N*-bromosuccinimide (NBS) (0.106 M), which was passed through a 4.10 mL loop at 0.900 mL min⁻¹ beginning 20 seconds prior to the enaminone flow. The product was a cream solid.

Yield: 85% (87.5 mg, 0.255 mmol); ¹H-NMR: (CDCl₃, 400 MHz) δ 7.35 (J = 7.6 Hz, 2H, d, H-7), 7.18 (J = 7.6 Hz, 2H, d, H-6), 6.04 (1H, s, NH), 4.49 (J = 5.4 Hz, 2H, d, H-5), 2.36 (4H, s, H-1 and H-4), 1.03 (6H, s, H-2 and H-3); ¹³C-NMR: (CDCl₃, 100 MHz) δ 187.4 (C=O), 159.0, 135.8, 133.8, 129.2, 127.9, 95.5, 50.3, 46.4, 40.1, 32.2, 28.2; *IR*: ν̄ 3221 (N-H), 2956, 2935, 2865, 1526 (C=O), 1447, 1388, 1313, 1294, 1240, 1152, 1090, 1014, 928, 904, 886, 795, 734, 640, 554; *Melting Point*: 178 – 179 °C; *R_f* (ethyl acetate) 0.83; *Mass Spectrometry*: TOF ES⁺: MH⁺: Expected: *m/z* 342.0260, Observed: *m/z* 342.0275, Difference = 4.39 ppm

Synthesis of (E)-3-bromo-4-(4-chlorobenzylamino)pent-3-en-2-one (332c)

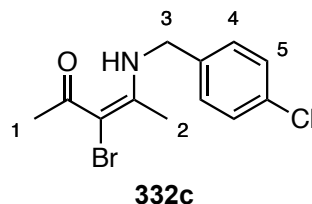

The procedure followed matched that described for **332a** using:

(Z)-4-(4-chlorobenzylamino)pent-3-en-2-one (**331c**) (0.101 M) was passed through a 3.00 mL loop to reach a reaction loop of 4.70 mL at 1.10 mL min⁻¹ and *N*-bromosuccinimide (NBS) (0.105 M), which was passed through a 4.10 mL loop at 0.900 mL min⁻¹ beginning 20 seconds prior to the enaminone flow. The product was an off-white solid.

Yield: 89% (81.8 mg, 0.270 mmol); ¹H-NMR: (CDCl₃, 400 MHz) δ 11.90 (1H, s, NH), 7.31 (J = 7.8 Hz, 2H, d, H-5), 7.17 (J = 7.8 Hz, 2H, d, H-4), 4.47 (J = 5.6 Hz, 2H, d, H-3), 2.38 (3H, s, H-1), 2.18 (3H, s, H-2); ¹³C-NMR: (CDCl₃, 100 MHz) δ 194.3 (C=O), 162.1, 136.0, 133.5, 129.0, 128.1, 92.4, 47.4, 30.4, 19.5; IR: $\bar{\nu}$ 3666 (N-H), 2988, 2901, 1561 (C=O), 1488, 1454, 1406, 1353, 1258, 1239, 1090, 1013, 954, 934, 802, 731, 667, 657, 563; *Melting Point:* 77 °C; *R_f* (ethyl acetate) 0.76; *Mass Spectrometry:* TOF ES⁺: MH⁺: Expected: *m/z* 301.9947, Observed: *m/z* 301.9937, Difference = 3.31 ppm

Synthesis of 2-bromo-3-(cyclohexylamino)cyclohex-2-enone (332d)

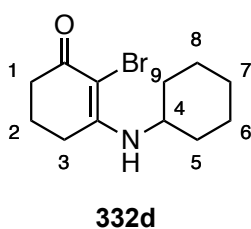

The procedure followed matched that described for **332a** using:

3-(cyclohexylamino)cyclohex-2-enone (**331d**) (0.099 M) was passed through a 3.00 mL loop to reach a reaction loop of 4.70 mL at 1.20 mL min⁻¹ and *N*-bromosuccinimide (NBS) (0.106 M), which was passed through a 4.10 mL loop at 0.900 mL min⁻¹ beginning 20 seconds prior to the enaminone flow. The product was a yellow oil.

Yield: 78% (63.2 mg, 0.232 mmol); ¹*H-NMR*: (CDCl₃, 400 MHz) δ 5.62 (J = 6.3 Hz, 1H, d, NH), 3.43 – 3.27 (1H, m, H-4), 2.58 (J = 5.5 Hz, 2H, t, H-1), 2.50 (J = 6.0 Hz, 2H, t, H-3), 1.95 – 1.18 (12H, m, H-2, H-5, H-6, H-7, H-8 and H-9); ¹³*C-NMR*: (CDCl₃, 100 MHz) δ 187.3 (C=O), 160.2, 95.6, 52.0, 36.7, 34.0, 26.6, 25.0, 24.4, 20.9; *IR*: $\bar{\nu}$ 3363 (N-H), 2920, 2848, 1627, 1553, 1446, 1405, 1322, 1187, 1143, 1103, 980, 915, 804, 725, 682, 528; *R_f* (ethyl acetate) 0.57; *Mass Spectrometry*: TOF ES⁺: MH⁺: Expected: *m/z* 272.0650, Observed: *m/z* 272.0652, Difference = -0.74 ppm

Synthesis of 2-bromo-3-(cyclohexylamino)-5,5-dimethylcyclohex-2-enone (332e)

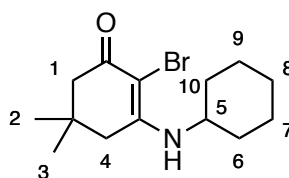

332e

The procedure followed matched that described for compound **332a** using:

3-(cyclohexylamino)-5,5-dimethylcyclohex-2-enone (**331e**) (0.102 M) was passed through a 3.00 mL loop to reach a reaction loop of 4.70 mL at 1.10 mL min⁻¹ and *N*-bromosuccinimide (NBS) (0.105 M), which was passed through a 4.10 mL loop

at 0.900 mL min⁻¹ beginning 20 seconds prior to the enaminone flow. The product was a yellow crystalline material.

Yield: 89% (112 mg, 0.274 mmol); *¹H-NMR:* (CDCl₃, 400 MHz) δ 5.61 (J = 6.7 Hz, 1H, d, NH), 3.39 – 3.31 (1H, m, H-5), 2.41 (2H, s, H-1), 2.35 (2H, s, H-4), 1.90 – 1.19 (10H, m, H-6, H-7, H-8, H-9 and H-10), 1.07 (6H, s, H-2 and H-3); *Melting Point:* 138 – 140 °C; Data in accordance with literature values.²³

Synthesis of 3-(benzylamino)-2-bromocyclohex-2-enone (**332f**)

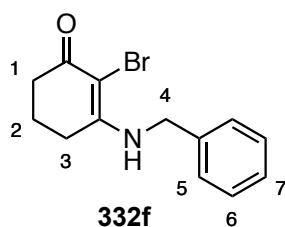

The procedure followed matched that described for **332a** using:

3-(benzylamino)cyclohex-2-enone (**331f**) (0.102 M) was passed through a 3.00 mL loop to reach a reaction loop of 4.70 mL at 1.00 mL min⁻¹ and *N*-bromosuccinimide (NBS) (0.105 M), which was passed through a 4.10 mL loop at 0.900 mL min⁻¹ beginning 20 seconds prior to the enaminone flow. The product was a cream solid.

Yield: 91% (77.8 mg, 0.278 mmol); *¹H-NMR:* (CDCl₃, 400 MHz) δ 7.42 – 7.20 (5H, m, H-5, H-6 and H-7), 6.15 (1H, s, NH), 4.53 (J = 4.9 Hz, 2H, d, H-4), 2.57 (J = 6.5 Hz, 2H, t, H-1), 2.49 (J = 6.7 Hz, 2H, t, H-3), 1.99 – 1.90 (2H, m, H-2); *Melting Point:* 128 – 130 °C (*Literature Value:* 128 – 130 °C); Data in accordance with literature values.²⁴

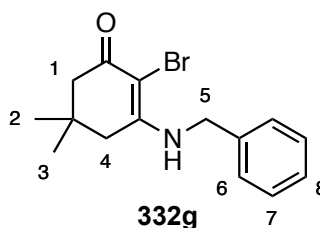
Synthesis of 3-(benzylamino)-2-bromo-5,5-dimethylcyclohex-2-enone (**332g**)

The procedure followed matched that described for **332a** using:

3-(benzylamino)-5,5-dimethylcyclohex-2-enone (**331g**) (0.101 M) was passed through a 3.00 mL loop to reach a reaction loop of 4.70 mL at 1.00 mL min⁻¹ and *N*-bromosuccinimide (NBS) (0.105 M), which was passed through a 4.10 mL loop at 0.900 mL min⁻¹ beginning 20 seconds prior to the enaminone flow. The product was a cream solid.

Yield: 96% (89.9 mg, 0.292 mmol); ¹*H-NMR*: (CDCl₃, 400 MHz) δ 7.41 – 7.25 (5H, m, H-6, H-7 and H-8), 6.13 (1H, s, NH), 4.53 (J = 5.5 Hz, 2H, d, H-5), 2.41 (2H, s, H-1), 2.37 (2H, s, H-4), 1.04 (6H, s, H-2 and H-3); *Melting Point*: 177 – 178 °C (*Literature Value*: 183 – 185 °C); Data in accordance with literature values.²⁴

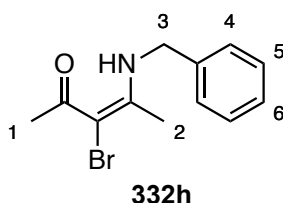
Synthesis of (*E*)-4-(benzylamino)-3-bromopent-3-en-2-one (**332h**)

The procedure followed matched that described for **332a** using:

(*Z*)-4-(benzylamino)pent-3-en-one (**331h**) (0.104 M) was passed through a 3.00 mL loop to reach a reaction loop of 4.70 mL at 1.15 mL min⁻¹ and *N*-

bromosuccinimide (NBS) (0.105 M), which was passed through a 4.10 mL loop at 0.900 mL min⁻¹ beginning 20 seconds prior to the enaminone flow. The product was a cream coloured solid.

Yield: 82% (68.9 mg, 0.257 mmol); ¹H-NMR: (CDCl₃, 400 MHz) δ 11.94 (1H, s, NH), 7.39 – 7.21 (5H, m, H-4, H-5 and H-6), 4.50 (J = 4.9 Hz, 2H, d, H-3), 2.38 (3H, s, H-1), 2.21 (3H, s, H-2); *Melting Point:* 82 °C; Data in accordance with literature values.²⁵

Synthesis of 2-bromo-3-(sec-butylamino)-5,5-dimethylcyclohex-2-enone (**332i**)

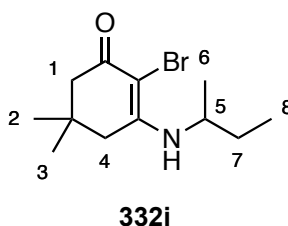

The procedure followed matched that described for **332a** using:

3-(sec-butylamino)-5,5-dimethylcyclohex-2-enone (**331i**) (0.098 M) was passed through a 3.00 mL loop to reach a reaction loop of 4.70 mL at 1.00 mL min⁻¹ and *N*-bromosuccinimide (NBS) (0.106 M), which was passed through a 4.10 mL loop at 0.900 mL min⁻¹ beginning 20 seconds prior to the enaminone flow. The product was a yellow solid.

Yield: 76% (61.4 mg, 0.224 mmol); ¹H-NMR: (CDCl₃, 400 MHz) δ 5.49 (J = 6.6 Hz, 1H, d, NH), 3.60 – 3.49 (1H, m, H-5), 2.40 (2H, s, H-1), 2.36 (2H, s, H-4), 1.59 – 1.49 (2H, m, H-7), 1.21 (J = 5.9 Hz, 3H, d, H-6), 1.07 (6H, s, H-2 and H-3), 0.93 (J = 7.0 Hz, 3H, t, H-8); ¹³C-NMR: (CDCl₃, 100 MHz) δ 186.8 (C=O), 158.7, 94.4,

50.6, 50.3, 40.3, 32.2, 30.7, 28.2, 28.2, 21.8, 10.2; *IR*: $\bar{\nu}$ 3345 (N-H), 2958, 2932, 2872, 1627, 1563, 1557, 1459, 1404, 1311, 1268, 1140, 1123, 1044, 993, 934, 909, 887, 780, 728, 640, 563; *Melting Point*: 67 – 68 °C; *R_f* (ethyl acetate) 0.71; *Mass Spectrometry*: TOF ES⁺: MH⁺: Expected: *m/z* 274.0807, Observed: *m/z* 274.0802, Difference = 1.82 ppm

Synthesis of 2-bromo-3-(2-bromobenzylamino)-5,5-dimethylcyclohex-2-enone (332j)

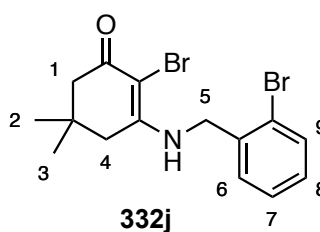

The procedure followed matched that described for **332a** using:

3-(2-bromobenzylamino)-5,5-dimethylcyclohex-2-enone (**331j**) (0.102 M) was passed through a 3.00 mL loop to reach a reaction loop of 4.70 mL at 1.00 mL min⁻¹ and *N*-bromosuccinimide (NBS) (0.105 M), which was passed through a 4.10 mL loop at 0.900 mL min⁻¹ beginning 20 seconds prior to the enaminone flow. The product was a cream solid.

Yield: 85% (101 mg, 0.261 mmol); ¹*H-NMR*: (CDCl₃, 400 MHz) δ 7.60 (J = 7.5 Hz, 1H, d, H-9), 7.35 (J = 7.1, 7.1 Hz, 1H, dd, H-7), 7.25 – 7.20 (2H, m, H-6 and H-8), 6.11 (1H, s, NH), 4.54 (J = 6.0 Hz, 2H, d, H-5), 2.38 (4H, s, H-1 and H-4), 1.04 (6H, s, H-2 and H-3); ¹³*C-NMR*: (CDCl₃, 100 MHz) δ 187.4 (C=O), 159.0, 136.4, 133.2, 129.6, 128.2, 128.0, 122.8, 95.6, 50.4, 47.4, 39.9, 32.2, 28.2; *IR*: $\bar{\nu}$ 3262 (N-H), 3064, 2957, 2901, 2883, 1574, 1531, 1394, 1385, 1313, 1295, 1254, 1193,

1101, 1086, 1025, 908, 800, 752, 660, 584, 567; *Melting Point*: 175 – 177 °C; R_f (ethyl acetate) 0.84; *Mass Spectrometry*: TOF ES⁺: MH⁺: Expected: m/z 385.9755, Observed: m/z 385.9744, Difference = 2.85 ppm

Synthesis of 2-bromo-3-(furan-2-ylmethylamino)-5,5-dimethylcyclohex-2-enone (332k)

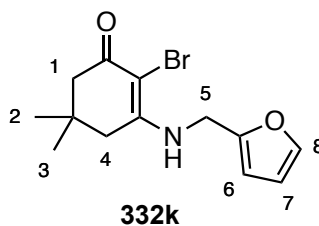

The procedure followed matched that described for **332a** using:

3-(furan-2-ylmethylamino)-5,5-dimethylcyclohex-2-enone (**331k**) (0.100 M) was passed through a 3.00 mL loop to reach a reaction loop of 4.70 mL at 1.00 mL min⁻¹ and *N*-bromosuccinimide (NBS) (0.105 M), which was passed through a 4.10 mL loop at 0.900 mL min⁻¹ beginning 20 seconds prior to the enaminone flow. The product was a yellow solid.

Yield: 84% (75.4 mg, 0.253 mmol); ¹H-NMR: (CDCl₃, 400 MHz) δ 7.38 (1H, s, H-8), 6.33 (1H, s, H-7), 6.23 (1H, s, H-6), 5.98 (1H, s, NH), 4.45 (J = 5.9 Hz, 2H, d, H-5), 2.50 (2H, s, H-1), 2.36 (2H, s, H-4), 1.07 (6H, s, H-2 and H-3); ¹³C-NMR: (CDCl₃, 100 MHz) δ 187.4 (C=O), 158.9, 150.2, 142.7, 110.5, 107.7, 95.4, 50.3, 40.4, 39.8, 32.1, 28.2; *IR*: $\bar{\nu}$ 3290 (N-H), 2959, 2929, 2890, 1618, 1581, 1525, 1444, 1406, 1308, 1276, 1254, 1147, 1103, 1069, 1005, 927, 916, 900, 884, 812, 733, 703, 619, 598, 565, 548; *Melting Point*: 138 – 139 °C; R_f (ethyl acetate) 0.77;

Mass Spectrometry: TOF ES⁺: MH⁺: Expected: *m/z* 298.0443, Observed: *m/z* 298.0449, Difference = -2.01 ppm

Synthesis of -2-bromo-5,5-dimethyl-3-(pyridin-2-ylmethylamino)cyclohex-2-enone
(332I)

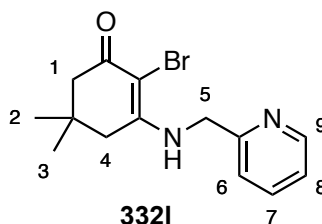

The procedure followed matched that described for **332a** using:

3-(pyridine-2-ylmethylamino)cyclohex-2-enone (**331I**) (0.103 M) was passed through a 3.00 mL loop to reach a reaction loop of 4.70 mL at 0.850 mL min⁻¹ and *N*-bromosuccinimide (NBS) (0.105 M), which was passed through a 4.10 mL loop at 0.900 mL min⁻¹ beginning 20 seconds prior to the enaminone flow. The product was brown coloured solid.

Yield: 90% (89.1 mg, 0.277 mmol); ¹H-NMR: (CDCl₃, 400 MHz) δ 8.61 (1H, s, H-9), 7.76 (J = 7.4, 7.4 Hz, 1H, dd, H-7), 7.32 – 7.25 (2H, m, H-6 and H-8), 7.03 (1H, s, NH), 4.66 (J = 3.9 Hz, 2H, d, H-5), 2.50 (2H, s, H-1), 2.39 (2H, s, H-4), 1.08 (6H, s, H-2 and H-3); ¹³C-NMR: (CDCl₃, 100 MHz) δ 187.2 (C=O), 159.2, 155.2, 149.1, 137.2, 122.8, 121.3, 94.9, 50.3, 47.6, 40.6, 32.1, 28.2; *IR:* ν̄ 3293 (N-H), 3047, 2958, 2928, 2900, 1713, 1558, 1476, 1454, 1403, 1305, 1275, 1226, 1211, 1176, 1151, 1106, 1078, 997, 924, 901, 886, 831, 771, 751, 727, 630, 602, 566, 545; *Melting Point:* 123 – 124 °C; *R_f* (ethyl acetate) 0.88; *Mass Spectrometry:* TOF ES⁺: MH⁺: Expected: *m/z* 309.0602, Observed: *m/z* 309.0602, Difference = 0.00 ppm

5.8. Experimental References

1. E. G. Occhiato, C. Prandi, A. Ferrali, A. Guarna and P. Venturello, *J. Org. Chem.* **2003**, 68, 25, 9728
2. J. J. Verendel, T. Zhou, J. –Q. Li, A. Paptchikhine, O. Lebedev and P. G. Andersson, *J. Am. Chem. Soc.* **2010**, 132, 26, 8880
3. A. R. Katritzky, H. Lang, Z. Wang, Z. Zhang and H. Song, *J. Org. Chem.* **1995**, 60, 7619
4. S. Dhiman and S. S. V. Ramasastry, *Org. Biomol. Chem.* **2013**, 11, 4299
5. P. Sharma, S. Kumar, F. Ali, S. Anthal, V. K. Gupta, I. A. Khan, S. Singh, P. L. Sangwan, K. A. Suri, B. D. Gupta, D. K. Gupta, P. Dult, R. A. Vishwakarma and N. K. Satti, *Med. Chem. Res.* **2013**, 22, 3969
6. S. J. Robinson, J. P. Petzer, A. Petzer, J. J. Bergh and A. C. U. Lourens, *Bioorg. Med. Chem. Lett.* **2013**, 23, 17, 4985
7. H. Deng, Z. –Y. Yu, G. –Y. Shi, M. –J. Chen, K. Tao and T. –P. Hou, *Chem. Biol. Drug Des.* **2012**, 79, 279
8. M. Kinger, Y. D. Park, J. H. Park, M. G. Hur, H. J. Jeong, S. –J. Park, W. S. Lee, S. W. Kim and S. D. Yang, *Arch. Pharmacol. Res.* **2012**, 35, 4, 633
9. K. Lee, W. P. Gallagher, E. A. Toskey, W. Chong and R. E. Maleczka Jr. *J. Organomet. Chem.* **2006**, 691, 8, 1462
10. A. S. Demir, C. Tanyeli, A. Cagir, M. N. Tahir and D. Ulku, *Tetrahedron: Asymmetry*, **1998**, 9, 1035
11. I. N. Chernyuk, M. K. Bratenko and M. I. Shevchuk, *J. Gen. Chem. USSR (Engl. Transl.)*, **1988**, 58, 2, 306

12. R. He and Y. Lam, *Org. Biomol. Chem.* **2008**, 6, 2182
13. B. Procuranti and S. J. Connon, *Org. Lett.* **2008**, 10, 21, 4935
14. B. M. Lamb and C. F. Barbas III, *Chem. Commun.* **2015**, 51, 3196
15. I. O. Edafiogho, K. V. V. Ananthalakshmi and S. B. Kombian, *Bioorg. Med. Chem.* **2006**, 14, 15, 5266
16. W. Urbaniak, R. Frański and B. Gierczyk, *Pol. J. Chem.* **2001**, 75, 3, 429
17. Y. L. Chen, P. S. Mariano, G. M. Little, D. O'Brien and P. L. Huesmann, *J. Org. Chem.* **1981**, 46, 23, 4643
18. G. H. Alt and A. J. Spieziale, *J. Org. Chem.* **1965**, 50, 5, 1407
19. W. –J. Bai, S. K. Jackson and T. R. R. Pettus, *Org. Lett.* **2014**, 16, 5, 1294
20. R. A. Laskar, N. A. Begum, M. H. Mir, S. Ali and A. T. Khan, *Tetrahedron Letters*, **2011**, 54, 5, 436
21. K. R. Scott, I. O. Edafiogho, E. L. Richardson, V. A. Farrar, J. A. Moore, E. I. Tietz, C. N. Hinko, H. Chang, A. El-Assadi and J. M. Nicholson, *J. Med. Chem.* **1993**, 36, 1947
22. A. Hasaninejad, A. Zare, M. R. Mohammadizadeh, M. Shekouhy and A. R. Moosavi-Zare, *E. –J. Chem.* **2010**, 7, 4, 1546
23. M. P. Nemeryuk, L. A. Tolokontseva, V. A. Yadrovskaya, A. I. Polezhaeva, G. A. Petrova, T. S. Safonova and M. D. Mashkovskii, *Pharm. Chem. J.* **1985**, 19, 7, 459
24. S. Pathak, A. Kundu and A. Pramanik, *RSC Adv.* **2014**, 4, 10180
25. P. Zhang and Z. Chen, *J. Chem. Research (S)*, **2003**, 570

Appendix A – X-ray Crystal Data

X-ray data for 269e

Empirical formula	C ₁₇ H ₂₀ O ₄
Formula weight	288.33
Temperature	100(2) K
Wavelength	0.71075 Å
Crystal system	Monoclinic
Space group	<i>P</i> 12 ₁ / <i>c</i> 1
Unit cell dimensions	$a = 8.6678(17) \text{ \AA}$ $\alpha = 90^\circ$ $b = 19.551(3) \text{ \AA}$ $\beta = 111.010(3)^\circ$ $c = 9.4202(17) \text{ \AA}$ $\gamma = 90^\circ$
Volume	1490.3(5) Å ³
Z	4
Density (calculated)	1.285 Mg / m ³
Absorption coefficient	0.091 mm ⁻¹
<i>F</i> (000)	616
Crystal	Block; Colourless
Crystal size	0.16 × 0.13 × 0.07 mm ³
θ range for data collection	2.517 - 27.545°
Index ranges	-11 ≤ <i>h</i> ≤ 11, -25 ≤ <i>k</i> ≤ 24, -12 ≤ <i>l</i> ≤ 10
Reflections collected	10597
Independent reflections	3410 [<i>R</i> _{int} = 0.0448]
Completeness to $\theta = 25.242^\circ$	99.9 %

Absorption correction	Semi-empirical from equivalents
Max. and min. transmission	1.000 and 0.606
Refinement method	Full-matrix least-squares on F^2
Data / restraints / parameters	3410 / 0 / 192
Goodness-of-fit on F^2	1.053
Final R indices [$F^2 > 2\sigma(F^2)$]	$R1 = 0.0417$, $wR2 = 0.1106$
R indices (all data)	$R1 = 0.0499$, $wR2 = 0.1156$
Extinction coefficient	N/A
Largest diff. peak and hole	0.285 and -0.191 e \AA^{-3}

Atom	x	y	z	U_{eq}	S.o.f.
O1	2282(1)	4834(1)	4706(1)	28(1)	1
O2	3882(1)	3517(1)	5097(1)	32(1)	1
O3	533(1)	6743(1)	11945(1)	28(1)	1
O4	- 1446(1)	5989(1)	9823(1)	28(1)	1
C1	3334(2)	4580(1)	6164(1)	25(1)	1
C2	2828(2)	4862(1)	7444(1)	26(1)	1
C3	2760(2)	5648(1)	7413(1)	25(1)	1
C4	1672(2)	5883(1)	5810(1)	28(1)	1
C5	2292(2)	5567(1)	4641(2)	29(1)	1
C6	3223(2)	3820(1)	6072(1)	26(1)	1
C7	2554(2)	3342(1)	6712(2)	31(1)	1
C8	2797(2)	2695(1)	6093(2)	37(1)	1
C9	3588(2)	2830(1)	5136(2)	38(1)	1
C10	2215(2)	5933(1)	8655(1)	24(1)	1
C11	3304(2)	6302(1)	9858(1)	26(1)	1
C12	2790(2)	6581(1)	10989(1)	26(1)	1
C13	1182(2)	6485(1)	10926(1)	24(1)	1
C14	85(2)	6085(1)	9744(1)	24(1)	1
C15	594(2)	5826(1)	8612(1)	25(1)	1
C16	1506(2)	7246(1)	12987(2)	33(1)	1
C17	- 2539(2)	5541(1)	8710(1)	29(1)	1

X-ray Data for 269g

Empirical formula	$C_{18}H_{22}O_5$
Formula weight	318.35
Temperature	100(2) K
Wavelength	0.71075 Å
Crystal system	Triclinic
Space group	<i>P</i> -1

Unit cell dimensions	$a = 6.9484(11) \text{ \AA}$ $\alpha = 80.017(6)^\circ$ $b = 9.9740(15) \text{ \AA}$ $\beta = 86.243(8)^\circ$ $c = 11.9674(18) \text{ \AA}$ $\gamma = 86.393(8)^\circ$
Volume	813.9(2) \AA^3
Z	2
Density (calculated)	1.299 Mg / m ³
Absorption coefficient	0.094 mm ⁻¹
<i>F</i> (000)	340
Crystal	Block; Colourless
Crystal size	0.17 × 0.17 × 0.12 mm ³
θ range for data collection	2.467 - 27.514°
Index ranges	$-9 \leq h \leq 9$, $-12 \leq k \leq 12$, $-12 \leq l \leq 15$
Reflections collected	10756
Independent reflections	3643 [$R_{\text{int}} = 0.0337$]
Completeness to $q = 25.242^\circ$	98.6 %
Absorption correction	Semi-empirical from equivalents
Max. and min. transmission	1.000 and 0.716
Refinement method	Full-matrix least-squares on F^2
Data / restraints / parameters	3643 / 0 / 211
Goodness-of-fit on F^2	1.122
Final <i>R</i> indices [$F^2 > 2\sigma(F^2)$]	$R1 = 0.0388$, $wR2 = 0.1076$
<i>R</i> indices (all data)	$R1 = 0.0440$, $wR2 = 0.1114$
Extinction coefficient	N/A
Largest diff. peak and hole	0.312 and -0.248 e \AA^{-3}

Atom	x	y	z	U_{eq}	S.o.f.
O1	6663(1)	1637(1)	10686(1)	23(1)	1
O2	3281(1)	1330(1)	12330(1)	24(1)	1
O3	906(1)	703(1)	6021(1)	22(1)	1
O4	- 1493(1)	2807(1)	5660(1)	24(1)	1
O5	1870(1)	5028(1)	8237(1)	22(1)	1
C1	5159(2)	2673(1)	10792(1)	21(1)	1
C2	3590(2)	2651(1)	9951(1)	21(1)	1
C3	4470(2)	2821(1)	8722(1)	19(1)	1
C4	6093(2)	1717(1)	8673(1)	22(1)	1
C5	7550(2)	1806(1)	9556(1)	24(1)	1
C6	4368(2)	2449(1)	11993(1)	20(1)	1
C7	4434(2)	3146(1)	12864(1)	22(1)	1
C8	3322(2)	2430(1)	13806(1)	23(1)	1
C9	2666(2)	1342(1)	13444(1)	24(1)	1
C10	2907(2)	2837(1)	7887(1)	19(1)	1
C11	2676(2)	1729(1)	7337(1)	20(1)	1
C12	1205(2)	1741(1)	6598(1)	19(1)	1
C13	- 85(2)	2885(1)	6397(1)	19(1)	1
C14	106(2)	3995(1)	6934(1)	20(1)	1
C15	1601(2)	3966(1)	7674(1)	18(1)	1
C16	2218(2)	- 466(1)	6211(1)	26(1)	1
C17	- 2920(2)	3904(1)	5498(1)	26(1)	1
C18	611(2)	6216(1)	8001(1)	29(1)	1

X-ray Data for 293b

Empirical formula	$C_{16}H_{19}ClO_4$
Formula weight	310.76
Temperature	100(2) K
Wavelength	0.71075 Å
Crystal system	Monoclinic

Space group	$P12_1/c1$
Unit cell dimensions	$a = 14.243(3) \text{ \AA}$ $\alpha = 90^\circ$ $b = 8.5982(19) \text{ \AA}$ $\beta = 105.996(3)^\circ$ $c = 12.723(3) \text{ \AA}$ $\gamma = 90^\circ$
Volume	$1497.8(6) \text{ \AA}^3$
Z	4
Density (calculated)	1.378 Mg / m^3
Absorption coefficient	0.268 mm^{-1}
$F(000)$	656
Crystal	Plate; Colorless
Crystal size	$0.1 \times 0.1 \times 0.02 \text{ mm}^3$
θ range for data collection	$2.797 - 27.536^\circ$
Index ranges	$-12 \leq h \leq 18, -11 \leq k \leq 11, -16 \leq l \leq 16$
Reflections collected	10350
Independent reflections	3392 [$R_{\text{int}} = 0.0446$]
Completeness to $\theta = 25.242^\circ$	99.4 %
Absorption correction	Semi-empirical from equivalents
Max. and min. transmission	1.000 and 0.600
Refinement method	Full-matrix least-squares on F^2
Data / restraints / parameters	3392 / 0 / 193
Goodness-of-fit on F^2	1.041
Final R indices [$F^2 > 2\sigma(F^2)$]	$R1 = 0.0438, wR2 = 0.1167$
R indices (all data)	$R1 = 0.0539, wR2 = 0.1238$
Extinction coefficient	N/A
Largest diff. peak and hole	0.363 and $-0.312 \text{ e \AA}^{-3}$

Atom	x	y	z	U_{eq}	S.o.f.
Cl1	5582(1)	4543(1)	3309(1)	36(1)	1
O1	7737(1)	6070(1)	10649(1)	22(1)	1
O2	8284(1)	6922(1)	8697(1)	20(1)	1
O3	10279(1)	2776(1)	9409(1)	24(1)	1
O4	10249(1)	2691(1)	7284(1)	24(1)	1
C1	7172(1)	6277(2)	11356(1)	23(1)	1
C2	6221(1)	6323(2)	10801(1)	26(1)	1
C3	6173(1)	6151(2)	9664(1)	26(1)	1
C4	7102(1)	6008(2)	9611(1)	19(1)	1
C5	7559(1)	5751(2)	8699(1)	18(1)	1
C6	7993(1)	4112(2)	8757(1)	20(1)	1
C7	8425(1)	3727(2)	7806(1)	18(1)	1
C8	8844(1)	2043(2)	7902(1)	19(1)	1
C9	9504(1)	1661(2)	9044(1)	21(1)	1
C10	9385(1)	1725(2)	7046(1)	22(1)	1
C11	7695(1)	3959(2)	6690(1)	18(1)	1
C12	7929(1)	4883(2)	5902(1)	21(1)	1
C13	7292(1)	5067(2)	4860(1)	22(1)	1
C14	6396(1)	4326(2)	4616(1)	24(1)	1
C15	6130(1)	3423(2)	5383(2)	33(1)	1
C16	6780(1)	3231(2)	6412(1)	28(1)	1

X-ray Data for 294g

Empirical formula	$C_{19}H_{24}O_6$
Formula weight	348.38
Temperature	100(2) K
Wavelength	0.71075 Å
Crystal system	Monoclinic
Space group	$P12_1/c1$

Unit cell dimensions	$a = 17.481(6) \text{ \AA}$	$\alpha = 90^\circ$
	$b = 7.270(2) \text{ \AA}$	$\beta = 114.170(5)^\circ$
	$c = 14.959(4) \text{ \AA}$	$\gamma = 90^\circ$
Volume	$1734.4(9) \text{ \AA}^3$	
Z	4	
Density (calculated)	1.334 Mg / m^3	
Absorption coefficient	0.099 mm^{-1}	
$F(000)$	744	
Crystal	Plate; Colourless	
Crystal size	$0.08 \times 0.06 \times 0.01 \text{ mm}^3$	
θ range for data collection	$2.554 - 27.550^\circ$	
Index ranges	$-22 \leq h \leq 22, -9 \leq k \leq 9, -19 \leq l \leq 14$	
Reflections collected	11956	
Independent reflections	3974 [$R_{\text{int}} = 0.0480$]	
Completeness to $\theta = 25.242^\circ$	99.8 %	
Absorption correction	Semi-empirical from equivalents	
Max. and min. transmission	1.000 and 0.632	
Refinement method	Full-matrix least-squares on F^2	
Data / restraints / parameters	3974 / 1 / 232	
Goodness-of-fit on F^2	1.026	
Final R indices [$F_2 > 2\sigma(F^2)$]	$R1 = 0.0416, wR2 = 0.1036$	
R indices (all data)	$R1 = 0.0565, wR2 = 0.1120$	
Extinction coefficient	N/A	
Largest diff. peak and hole	0.320 and $-0.252 \text{ e \AA}^{-3}$	

Atom	x	y	z	U_{eq}	S.o.f.
O1	1545(1)	6381(1)	- 960(1)	18(1)	1
O2	74(1)	4131(1)	- 1653(1)	20(1)	1
O3	4381(1)	5952(1)	4004(1)	20(1)	1
O4	4223(1)	8733(1)	4987(1)	20(1)	1
O5	1928(1)	11134(1)	2074(1)	22(1)	1
O6	3277(1)	10813(1)	- 234(1)	24(1)	1
C1	1059(1)	6091(2)	- 397(1)	17(1)	1
C2	1619(1)	6231(2)	698(1)	17(1)	1
C3	2042(1)	8133(2)	935(1)	17(1)	1
C4	2508(1)	8490(2)	267(1)	18(1)	1
C5	1907(1)	8185(2)	- 804(1)	18(1)	1
C6	643(1)	4269(2)	- 688(1)	17(1)	1
C7	692(1)	2650(2)	- 225(1)	19(1)	1
C8	125(1)	1413(2)	- 940(1)	20(1)	1
C9	- 226(1)	2365(2)	- 1783(1)	20(1)	1
C10	2611(1)	8362(2)	2016(1)	17(1)	1
C11	3243(1)	7059(2)	2491(1)	18(1)	1
C12	3774(1)	7215(2)	3474(1)	18(1)	1
C13	3693(1)	8734(2)	4007(1)	17(1)	1
C14	3089(1)	10070(2)	3551(1)	17(1)	1
C15	2545(1)	9861(2)	2561(1)	17(1)	1
C16	4452(1)	4351(2)	3491(1)	26(1)	1
C17	4200(1)	10307(2)	5548(1)	22(1)	1
C18	1731(1)	12458(2)	2659(1)	23(1)	1
C19	2879(1)	10418(2)	407(1)	21(1)	1